

# CONTENTS

## ABOUT THIS BOOK 6

### HOW TO USE THIS BOOK

8

### GLOSSARY OF LIGHTING TERMS

10

### NUDES

13

#### CHAPTER ONE

APPROACHING NUILITY

16

#### CHAPTER TWO

CLASSICAL NUDES

36

#### CHAPTER THREE

THE SEMI-DOMESTIC NUDE

58

#### CHAPTER FOUR

FANTASIES

74

#### CHAPTER FIVE

MALE NUDES AND COUPLES

96

#### CHAPTER SIX

THE OUTDOOR NUDE

114

#### CHAPTER SEVEN

SYMBOLS AND EXPERIMENTS

130

#### EROTICA

150

#### CHAPTER EIGHT

EROTIC FANTASY

154

#### CHAPTER NINE

ABSTRACTS AND BODY PARTS

176

#### CHAPTER TEN

ACCESSORIES AND PROPS

194

#### CHAPTER ELEVEN

TEXTURES, PATTERNS AND FORMS

212

#### CHAPTER TWELVE

FETISH APPEAL

232

#### CHAPTER THIRTEEN

THE ROMANTIC LOOK

250

#### CHAPTER FOURTEEN

PUSHING THE BOUNDARIES

274

#### PROVOCATIVE SHOTS

292

#### CHAPTER FIFTEEN

SIMPLY NAKED

296

#### CHAPTER SIXTEEN

HAIR AND MAKE-UP

314

#### CHAPTER SEVENTEEN

STRIKING A POSE

330

#### CHAPTER EIGHTEEN

PROPS

352

#### CHAPTER NINETEEN

EFFECTS AND FINISHING

372

#### CHAPTER TWENTY

DRESSING UP

394

#### CHAPTER TWENTY-ONE

VOYEURISTIC SHOTS

412

#### DIRECTORY OF PHOTOGRAPHERS

434

#### ACKNOWLEDGMENTS

448

# ABOUT THIS BOOK

The most common response from the photographers who contributed to this book, when the concept was explained to them, was "I'd buy that". The aim is simple: to create a library of books, illustrated with first-class photography from all around the world, which show exactly how each individual photograph in each book was lit.



# HOW TO USE THIS BOOK

The lighting drawings in this book are intended as a guide to the lighting set-up rather than as absolutely accurate diagrams. Part of this is due to the variation in the photographers' own drawings, but part of it is also due to the need to represent complex set-ups in a way which would not be needlessly confusing.

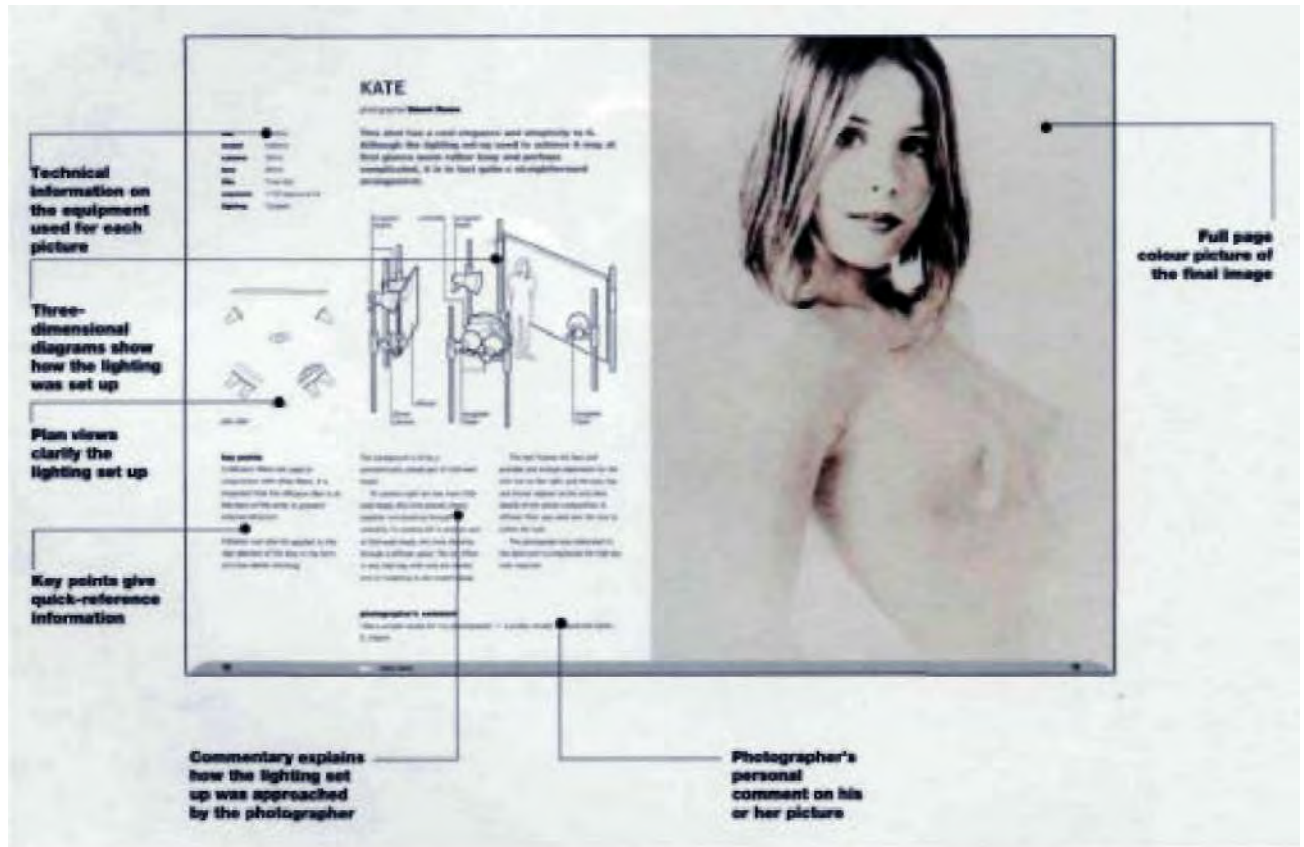

Distances and even sizes have been compressed and expanded: and because of the vast variety of sizes of soft boxes, reflectors, bounces and the like, we have settled on a limited range of conventionalized symbols. Sometimes, too, we have reduced the size of big bounces, just to simplify the drawing. None of this should really matter, however. After all, no photographer works strictly according to rules and preconceptions: there is always room to move this light a little to the left or right, to move that light closer or

further away, and so forth, according to the needs of the shot. Likewise, the precise power of the individual lighting heads or (more important) the lighting ratios are not always given; but again, this is something which can be "finetuned" by any photographer wishing to reproduce the lighting set-ups in here. We are however confident that there is more than enough information given about every single shot to merit its inclusion in the book: as well as purely lighting techniques, there are also all kinds of hints and tips about commercial realities, photographic

practicalities, and the way of the world in general.

The book can therefore be used in a number of ways. The most basic, and perhaps the most useful for the beginner, is to study all the technical information concerning a picture which he or she particularly admires, together with the lighting diagrams, and to try to duplicate that shot as far as possible with the equipment available.

A more advanced use for the book is as a problem solver for difficulties you have already encountered: a

particular technique of back-lighting, say, or of creating a feeling of light and space. And, of course, it can always be used simply as a source of inspiration.

The information for each picture follows the same plan, though some individual headings may be omitted if they were irrelevant or unavailable. The photographer is credited first, then the client, together with the use for which the picture was taken. Next come the other members of the team who worked on the picture: stylists, models, art directors, whoever. Camera and lens come next, followed by film. With film, we have named brands and types, because different films have very different ways of rendering colours and tonal values. Exposure comes next: where the lighting is electronic flash, only the aperture is given, as illumination is of course independent of shutter speed. Next, the lighting equipment is briefly summarised — whether tungsten or flash, and what sort of heads — and finally there is a brief note on props and backgrounds. Often, this last will be obvious from the picture, but in other cases you may be surprised at what has been pressed into service, and how different it looks from its normal role.

The most important part of the book is, however, the pictures themselves. By studying these, and referring to the lighting diagrams and the text, you can work out how they were done.

The following is a key to the symbols used in the three-dimensional and plan view diagrams. All commonly used elements such as standard heads, reflectors etc., are listed. Any special or unusual elements involved will be shown on the relevant diagrams themselves.

### THREE-DIMENSIONAL DIAGRAMS



# NUDES

**From the very earliest days of photography, and indeed from the earliest days of representational art, the portrayal of the nude and partially nude human form has exercised an enduring fascination. By the early 1850s there were numerous daguerreotypists in Paris in particular who were noted for their photography of the nude: Auguste Bellocq, Bruno Braquehais, Jean-Louis-Marie-Eugene Durieu, F. Jacques Moulin, Louis Camille d'Olivier and more.**

Some of this early work was nothing more nor less than pornography, but co-existing with this was an artistic tradition which stretched back hundreds or even thousands of years: a representation of a nude can after all be attractive without being erotic, or erotic without being pornographic. What is surprising, to the modern eye, is how many of the early photographers seem to have made no particular distinction: Moulin, in particular, produced some quite charming pictures, and others which even his most ardent admirers would be hard pressed to defend on aesthetic grounds.

This is the central problem in all nude photography: which pictures are "acceptable", and to whom. There are no doubt many who would like to see even this book burned, while there are others who will be unable to see why a single image in here could upset anyone. Art, like depravity, is something which is easier to recognize than to define.

This is not, however, the place for such a debate. Nor is it the place for a discussion of why individual photographers take pictures of nudes. You have presumably bought the book, or you are contemplating buying it, and so it is our job to give you as

much guidance as possible on how to photograph the nude - which for our purpose includes the partially nude, as a book containing nothing but total nudity would be more use as an anatomy book than as a book on photography. We have drawn work from photographers from numerous countries, all with their own unique styles and ways of working. Our job has been merely to learn from them how they work, to organize that information, and to make it as useful and informative as possible.

## **Studios and Settings**

It might have been useful -though, unfortunately, it would not have been practical - to include a chapter of historical images in this book. It could have begun with the static nineteenthcentury nudes in their stuffy studios; moved on to the Edwardians, with their naturalistic studio sets and locations; then gone on to the period between World War One and World War Two, the heyday of the geometrical nude and the semiabstract "figure study"; taken in the 1950s, with their emphasis on the outdoors, and the 1960s with their gritty photo-realism; and the selfindulgence which characterized so much of the 1970s...

Of course, as we come nearer to

our own times it becomes harder and harder to recognize underlying trends. There also seems to be more diversity than ever before. In this book there are very simple studio nudes, shorn of context or with only the simplest of backdrops, but there are also nudes in natural (or naturalistic) settings; in abandoned buildings; out of doors and indoors; photographed with the utmost in romanticism, or in the grittiest of realism. Unlike the case of some other books in the PRO LIGHTING series, generalizations are very hard to make: photographing the nude is one of the most intensely personal forms of photography.

## **Photography and Painting**

More than in almost any other area of photography, the link between the photographed nude and the painted nude is abundantly clear, and the photographer who looks only at the works of other photographers and ignores the works of painters is making a serious mistake. There are pictures in these pages which are reminiscent of Alma-Tadema, Balthus, Hockney and even Liechtenstein. A tour of any art gallery, or a few books on painting, can be worth as much as a visit to a photographic gallery, even if it is showing the works of an

acknowledged master such as Bill Brandt, Helmut Newton, or Jock Sturges.

## **Clothes, Props and Make-up**

As already remarked, the totally unclothed nude is unusual; and there is quite a lot of fashion and personal originality in what he or she may be clothed with. Diaphanous draperies were always popular with the painters of yore, and, within the bounds imposed by the greater literalness of photography, the same may also be found in these pages: lengths of fabric, and even sheets, are pressed into service on a regular basis. More conventional clothes may be partially undone, or underwear may be revealed, or clothes normally regarded as essential for decency may be omitted.

When it comes to props and backgrounds, there is a long tradition of geometrical or semi-abstract nudes, where props normally look out of place; but there is no doubt that in the vast majority of nude studies props are an essential part of the picture. This is true whether you are considering the irreverent humour of Michele Francken or the almost apocalyptic intensity of some of Stu Williamson's pictures; and in one of Struan's most notable pictures, the model herself is essentially a prop because the picture was commissioned as an advertising photograph for a shoe.

As for hair and make-up, this is something which dates far faster than most people (especially most men) realize. Examples like the old "beehive" hairdo are obvious, but compare the heavy eye make-up and often unnatural but often dramatic lipsticks of the 1960s with the more naturalistic eye-make-up and washed-out lipsticks of the late 1970s and early 1980s. This is one reason why

timeless-looking young girls with long hair are often preferred by photographers. Another is that gravity has taken less of a toll of their figures.

## **Cameras, Lenses and Film for Nudes**

Commercially, roll-film cameras have it all: they offer a bigger image than 35mm, with commensurately better quality, and the old argument of "big fee - big camera" has a certain logic to it.

What is interesting, though, is how many photographers choose 35mm for their personal work. In particular, even when Struan has been shooting commercially with his Hasselblad, he may switch to 35mm for his personal shots, several of which appear in here. Likewise, Julia Martinez said of one set of pictures (of which two appear in this book), "I was just working with 35mm, and the freedom was wonderful; no big, heavy cameras and no lights to move around. The model felt more relaxed, too."

Going in the other direction, very few photographers shoot large format nudes any more, although there is a handful of 4x5in shots in this book. Longer-than-standard lenses are very much the norm, although there are also plenty of wide-angle shots in the book: Struan with 35mm and even 28mm on 35mm, Guido Paterno Castello with 50mm on 6x6cm, Peter Goodrum with 90mm on 4x5in.

As for films, a surprisingly high proportion of pictures in this book were shot on black and white – or perhaps it is not quite such a surprise, given the way in which so many photographers shoot nudes for fun, rather than for profit. Many photographers still have a sneaking suspicion that monochrome is more "real" than colour, while others

simply maintain that it gives them more control and better enables them to realize their personal photographic vision. There seems to be no overall preference for a particular type or even brand of black and white film, and Stu Williamson makes a particular point of using a wide range of monochrome films for different tonal effects.

## **Lighting Equipment for Nudes**

Yet again, generalizations are impossible: unlike (for example) food or pack shots, there are not even any particularly common lighting set-ups. In these pages you will find everything from available light to monster soft boxes to on-camera flash, taking in a number of quite complex lighting setups on the way. A basic kit would probably consist of three heads, two of which would be used for lighting the background, though everything from single-light pictures to those using four or five lights will be found in this book. It is also worth mentioning Stu Williamson's ingenious Tri-Flector, which is described more fully on page 24.

And, of course, many photographers shoot nudes only by available light; you will find plenty of examples of these, too.

## **The Team**

Most photographers of the nude work on their own most of the time. There are two main reasons for this. The first is simple economics: a lot of nude photography is done for personal or portfolio work, and the budget simply does not stretch to an assistant. There are exceptions, as when a personal shot is grafted onto a commissioned shoot, but this is the exception rather than the rule. The other reason is that nude

photography requires a certain rapport between the subject and the model, and it is often difficult to establish that rapport if a third person is present. On the one hand, the third person may reassure the model – this is especially true if the third person is of the same sex as the model - on the other, he or she may seem like an intrusion: the photographer is, as it were, licensed to see the model in the nude, but other people are not.

d'Antibes most certainly does not go in the Bois de Boulogne. Finally, remember this. More than most kinds of photography, taking pictures of nudes is a matter of mood. That mood may be timeless, or deliberately confrontational, or erotic, or innocent, or a hundred other things; but if the mood you want is not the same as the mood you are getting, this more than anything else will stop you taking the pictures you envisioned.

### **The Nude Photography Session**

Because nude photography is so intensely personal, and because models vary so widely in temperament and attitude, only a few general remarks are appropriate.

The most important ones concern the facilities for the model. She should be able to dress and undress in privacy, because nude modelling is not the same as doing a strip-tease. This privacy can be a changing room, or a car with a sheet draped over the windows and weighted or taped down at the corners. She should be able to keep warm between shots: a clean, soft blanket is a useful thing to have to hand. She should of course have been warned beforehand not to wear tight clothing, as marks on the skin can take hours to disappear. Other people should be excluded as far as possible, though a few models seem to be born exhibitionists and deliver their best work in front of a large and appreciative audience. In some countries, or in some locations, there may be a problem with public nudity. At the very least, this can make a shoot awkward, and at the worst it may involve arrest or assault or both. If you are in an unfamiliar country, check local mores as far as possible - and remember, what goes in San Francisco may not go in Kansas, and what goes at the Cap





1

approaching

nudity



A perennial problem, particularly with inexperienced models, is getting them to feel relaxed about nudity. The first chapter in this book therefore deals with "almost nude" pictures - a means of easing models into nudity gently. If you can show them Polaroids as you go along, this can still further reassure them that they are not being represented in a way which would make them unhappy. Of course, this is not the only reason to take "almost nude" pictures, and (to be fair) it is not the reason why most of the pictures in this chapter were taken. There are portraits here, taken (in the photographer's words) to be "revealing but not too revealing"; there are advertising shots; and there are portfolio and personal shots.

Lighting ranges from outdoor through natural indoor light and single-light pictures to a complex four-head set-up. The majority were shot using MF cameras ranging from 645 to 6x7cm, though there are two 35mm shots here. The beginner would be well advised to use medium format, not least because it looks more professional and may well reassure the model; but from a purely technical point of view it does not necessarily matter very much which format you use. There are five monochrome pictures, three in conventional colour, and one cross-processed.

Photographer: **Michele Francken**  
 Client: **Mac 3 Company**  
 Use: **Advertising**  
 Camera: **6x6cm**  
 Lens: **110mm with Softar screen**  
 Film: **Kodak Ektachrome EPP 100**  
 Exposure: **f/8**  
 Lighting: **Electronic flash: 1 head**  
 Props and set: **Hand-painted backdrop**

## NUDE



Plan View

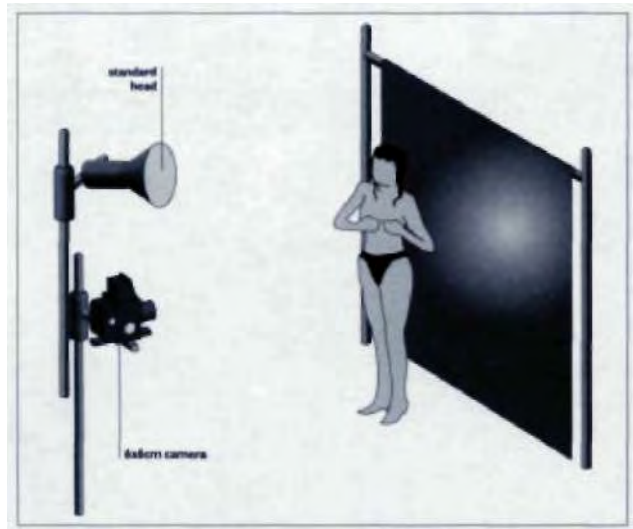

LIGHTING IS SUBJECT TO OCKHAM'S RAZOR: LIGHTS (LIKE LOGICAL ENTITIES) SHOULD NOT BE MULTIPLIED WITHOUT REASON. HERE A SINGLE LIGHT SUFFICES TO CREATE A MEMORABLE PICTURE. NOT EVEN A BOUNCE IS USED TO SUPPLEMENT THE LIGHTING PLOT.

- *Pointed backdrops can be graded, or may give the impression of being spotlighted. Some photographers paint their own, but there are manufacturers who specialize in custom or unusual backdrops*
- *The effects obtainable with a painted backdrop can vary widely depending on the subject's distance from the backdrop, the lighting of the backdrop, and the aperture employed*

The backdrop is however a little unusual. The apparent more variation in tone. The apparent drawback to such a background is that it is monotonous - but this is only the case for the photographer, because the subjects normally see only their own picture against that ground. Also, considerable differences can be effected, depending on where the subject is placed against the "hot spot."

The model's shadow is just about visible to the lower left, yet the background is monotonous - but this is only the case seems brightly spotlighted. This is for the photographer, because the normally achieved with additional lighting, subjects normally see only their own but another way to do it is to have a picture against that ground. Also, backdrop which is painted as if it were considerable differences can be effected, spotlighted: in other words, it is painted in depending on where the subject is somewhat the same way as a graded placed against the "hot spot." background, but less smoothly and with

### Photographer's comment:

This sort of lighting is used to create a more sensuous express/on. A Softar filter is used to soften the skin.



Photographer: **Bob Shell**

Use: **Personal work**

Model: **Audra Fregia**

Camera: **645**

Lens: **80mm**

Film: **Ilford FP4**

Exposure: **1/60 sec at f/8**

Lighting: **Available light**

## AUDRA AT THE WINDOW



Plan View

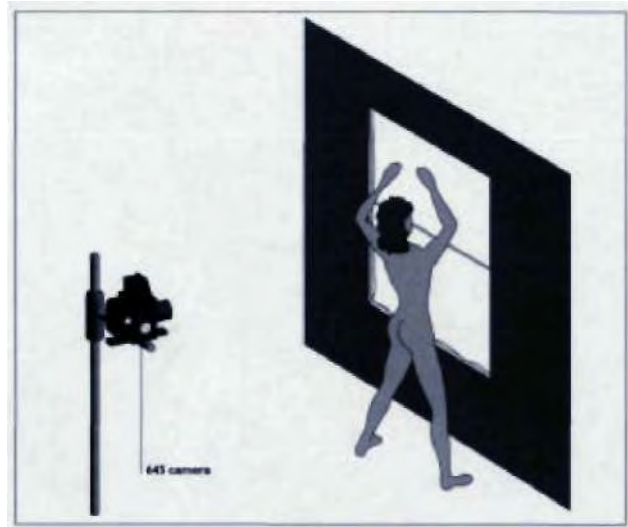

PERHAPS THE MOST IMPORTANT THING TO NOTE HERE IS THAT THE WINDOW IS COVERED WITH FROSTED MYLAR, MAKING IT A NATURAL SOFT BOX AND ALSO MAKING IT OPAQUE SO THAT THE MODEL CANNOT BE SEEN FROM THE STREET.

This sort of silhouette, combined with curtains and the lace of the peignoir is doubly effective. Flare is of course a potential problem and unless the intention is extremely effective while still showing remarkably little that could offend any but the most prudish viewer. The shape of the model is beautifully illustrated, and the contrast between the lace of the

- *Frosted Mylar and Kodatrace rebot/I superb diffusion materials, but in colour Kodatrace introduces a very slight green Cast*

- *There is a significant difference between a window receiving direct sun (like this one, which faces north-west) and a window which is illuminated only by skylight*



Photographer: **Ron McMillan**  
 Client: **Beauty Products Catalogue**  
 Use: **Catalogue**  
 Model; **Emma Noble**  
 Assistant: **Paul Cromey**  
 Camera: **6x6cm**  
 Lens: **120mm + Softar II soft-focus**  
 Film: **Kodak Panther XI00**  
 Exposure: **f/16**  
 Lighting: **Electronic flash: 2 striplights**  
 Props and set: **Seamless background**

## EMMA

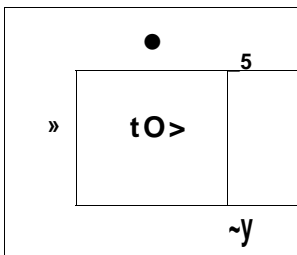

Plan View



OFTEN, A NUDE SHOT FOR ADVERTISING MUST REVEAL VERY LITTLE; IT MUST LOOK NATURAL AND CHARMING, BUT NOT REVEALING. THIS IS A TIMELESS PICTURE WHICH MIGHT ONCE HAVE SEEMED RISQUE BUT WHICH IS ENTIRELY ACCEPTABLE IN THE LATE 20TH CENTURY.

- *Strip lights are more directional than soft boxes, at least in the short axis*
- *This is an interesting example of white-on-white; the towel is lighter than the background on the left, and darker than the background on the right*

The lighting is certainly simple: a vertical strip light to camera left, illuminating the model's back and a horizontal strip light on the floor behind the model, illuminating the background and in the process providing a modest amount of fill on the model's arm and on the towel. Compared with the model, the vertical light is very slightly nearer the camera, to provide a glancing light rather than a pure

side-light. As so often, it is not the complexity of the lighting which is important, but its appropriateness; and analyzed more carefully, this profile semi-high-key approach is unusual and effective. The use of a white towel on the dark side of the model, away from the light, saves it from being too dark as well as suggesting natural, unaffected beauty.





Photographer: **Stu Williamson**  
 Client: **Andrea (model)**  
 Use: **Portrait**  
 Camera: **6x7cm**  
 Lens: **140mm**  
 Film: **Word FP4**  
 Exposure: **f/11**  
 Lighting: **Electronic flash: one head**  
 Props and set: **Lastolite "Thunder"  
 painted backdrop**

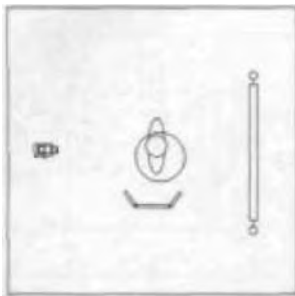

Plan View

## ANDREA

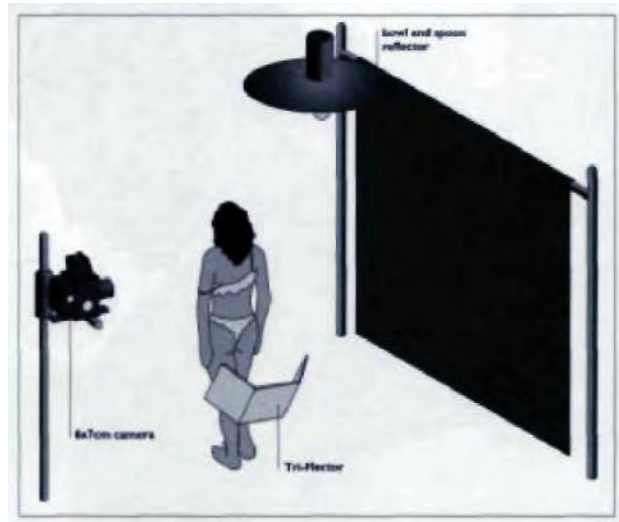

OFTEN, A NUDE SHOT FOR ADVERTISING MUST REVEAL VERY LITTLE; IT MUST LOOK NATURAL AND CHARMING, BUT NOT REVEALING. THIS IS A TIMELESS PICTURE WHICH MIGHT ONCE HAVE SEEMED RISQUE BUT WHICH IS ENTIRELY ACCEPTABLE IN THE LATE 20TH CENTURY.

This light is well above the model and directed with considerable precision. The camera right, as may be seen from the picture was then printed with dramatic shadows; but Stu also used his trademark "Tri-Flector" (which he invented and which is manufactured by Lastolite). This has a central panel flanked by two "wings" which allow the light to be

directed with considerable precision. The picture was then printed with dramatic dodging - Stu prints all his own work -and the pink colour was added with Fotospeed dyes. The shaped background is more an effect of printing than of lighting.

- *Large reflectors give a different quality of light from soft boxes*
- *Hand colouring can add impact to a monochrome nude*
- *The contrast between tanned and untanned areas (if the model has not got an overall tan) can be used to good effect in some shots*

### Photographer's comment:

The model wanted a picture for her boyfriend. It had to be intimate and revealing without being too revealing

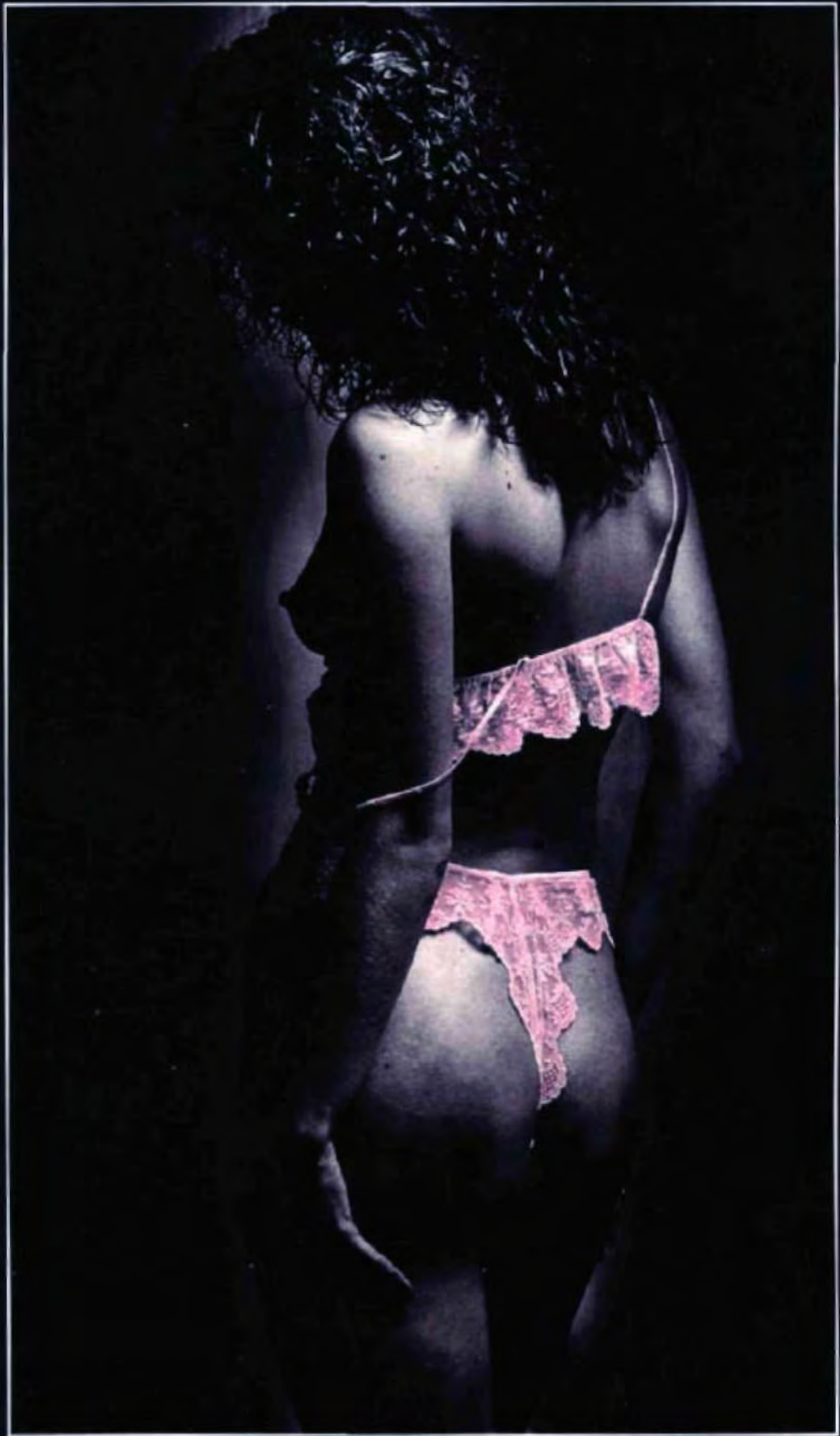



Photographer: **Stu Williamson**  
 Client: **Tanya**  
 Use: **Portrait**  
 Camera: **6x7cm**  
 Lens: **90mm**  
 Film: **Ilford Pan F**  
 Exposure: **f/11**  
 Lighting: **Electronic flash: 4 heads**  
 Props and set: **Colorama hand-painted b/g; crown by Terry English, armourer**

## TANYA

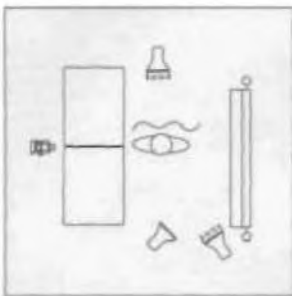

Plan View

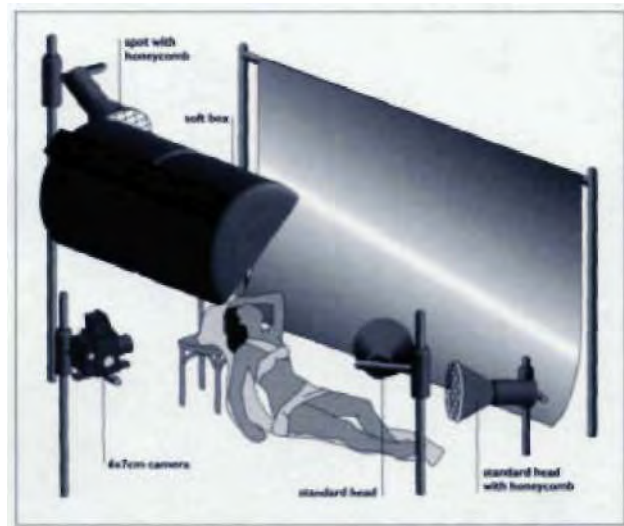

THE MODEL IS SURPRISINGLY FULLY CLOTHED, BUT BECAUSE OF THE WAY THE "CLOTHES" ARE ARRANGED, SHE LOOKS LESS DRESSED THAN SHE IS. THE SEMI-CLASSICAL POSE AND BACKDROP CONTRIBUTE STILL MORE TO THE OVERALL AURA OF SENSUALITY.

- *If a single light will not do what you want, ask yourself what it would illuminate if it were doing what you want*
- *Painted backdrops can have more than one centre of interest - or two backdrops can sometimes be combined*

The lighting is of course important too. The key is the honeycombed spot to camera left, illuminating (in particular) her face and chest. This is supplemented by another honeycombed head to camera right, rimlighting the model's legs. A large soft box, just above the camera, acts as a general fill and provides some of the illumination of the background, which is also lit with a fourth head coming in from camera right.

This is a good example of a second light being added to the key to create the illusion of one light: the key and the rimlight combine flawlessly, creating the impression of a single light source.

### Photographer's comment:

I use a wide variety of different black and white films for different tonalities.

Photographer: **Julia Martinez**

Use: **Personal work**

Model: **Becky**

Camera: **645**

Lens: **300mm**

Film: **Kodak T-Max 100**

Exposure: **f/11**

Lighting: **Electronic flash: 3 heads**

Props and set: **White background - and see**

## RECESSION      DRESSING

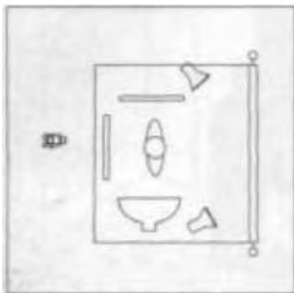

Plan View

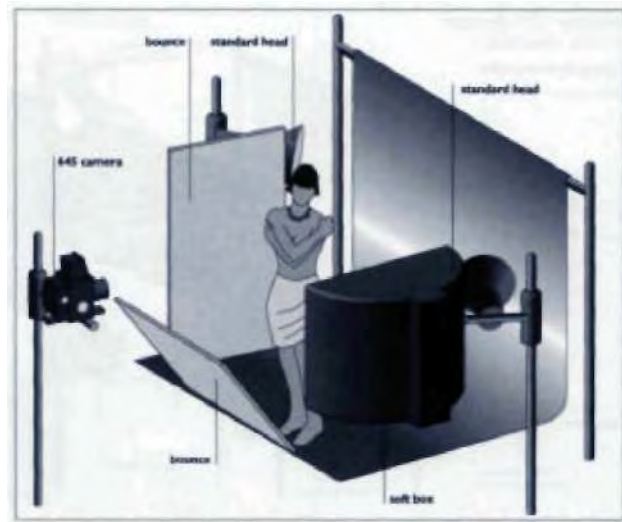

JULIA MARTINEZ WAS AT FIRST BEST KNOWN FOR HER GENTLE AVAILABLE-LIGHT PICTURES BUT, AS THE PHOTOGRAPHS IN THIS BOOK SHOW, SHE IS ALSO QUITE AT HOME WITH OTHER LIGHT SOURCES - IN THIS CASE STUDIO FLASH.

- *Chiaroscuro and high key are less incompatible than they might seem*
- *Some photographers' style is intimately bound up with their lighting technique; others are more recognizable from their compositional approach*

The key and indeed only light on the subject is a 120x 120cm (4x4ft) soft box to camera right, beside the model. Two bounces, one to camera left and the other below the camera's line of sight, even out the light considerably while still maintaining strong modelling. Finally, a couple of lights on the background create a classic high-key effect.

The printed

image was toned blue using Fotospeed materials.

The overall effect is classical and simple. It illustrates, as do most good pictures, that the single most important thing is the photographer's eye. Why is the image framed this way? Would you have framed it this way? And why does it "work" so well?

### **Photographer's comment:**

This was shot for a college assignment on "recession dressing". The necklace is made of Coca-Cola can pulls....

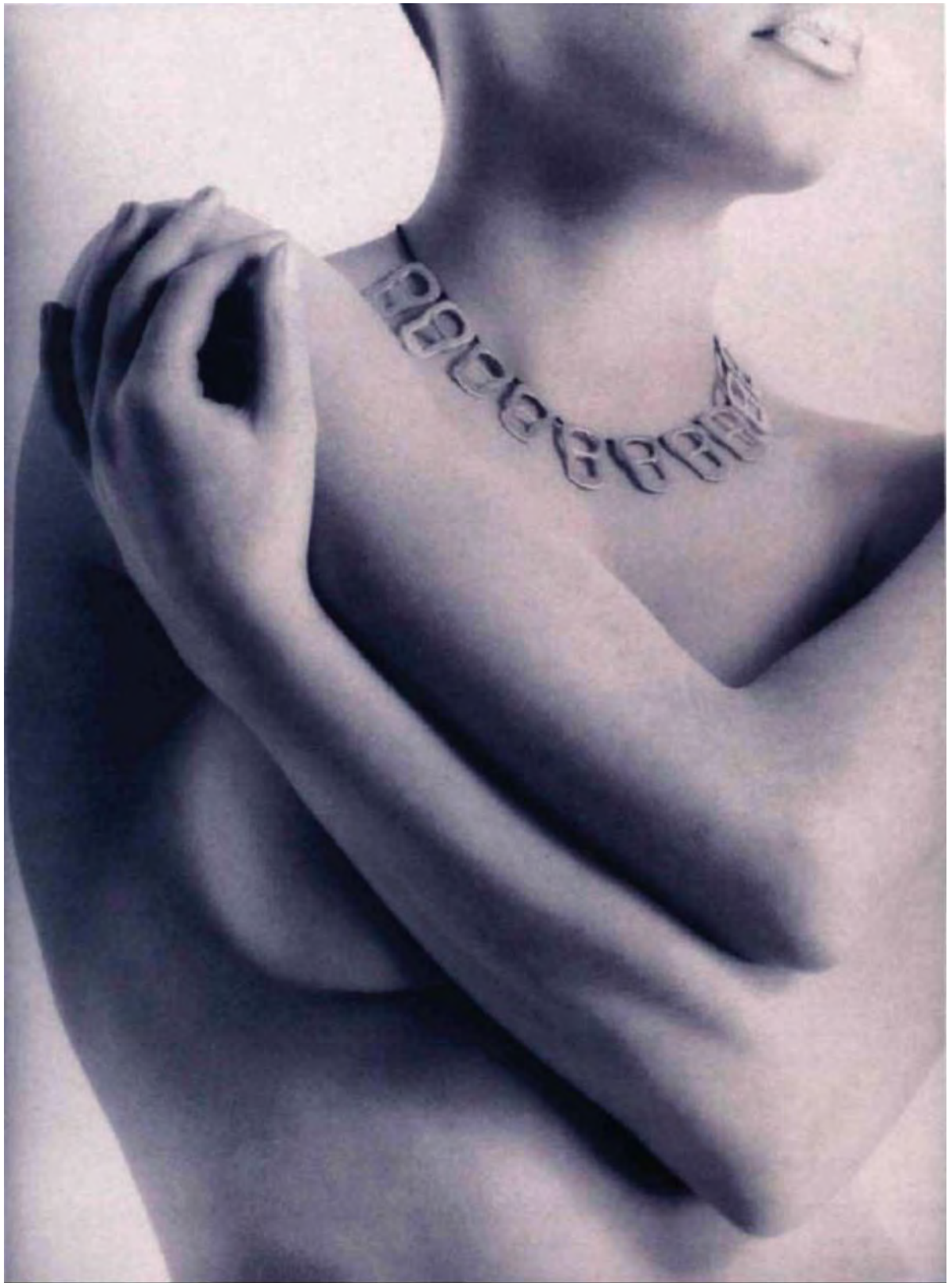

Photographer: **Frank P. Wartenberg**

Use: **Portfolio**

Camera: **35mm**

Lens: **85mm**

Film: **Polaroid Polagraph**

Exposure: **Not recorded**

Lighting: **Late sun**

Props and set: **Location (beach)**

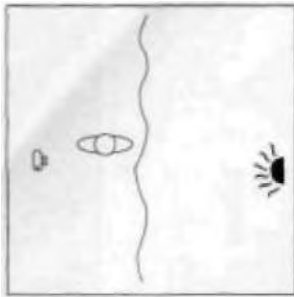

Plan View

## LATE SUN



MANY PHOTOGRAPHERS USE POLAROID POLAPAN FOR ITS UNIQUE AND RATHER OLD-FASHIONED TONALITY - WHICH IS OFTEN MORE IMPORTANT THAN "INSTANT" PROCESSING - BUT THE MORE EXPERIMENTALLY MINDED HAVE DISCOVERED JUST WHAT ITS HIGHER-CONTRAST COUSIN, POLAROID POLAGRAPH, CAN DO.

Frank Wartenberg is particularly fond of this film and as he demonstrates here, there is no need to take seriously the warning that it is not intended for general-purpose photography. Even in the relatively contrasty conditions of direct sunlight, it can deliver an excellent tonal range and remarkable subtlety.

Exposure must however be very precise if the highlights are not to be "blown" or the shadows too extensive. Like any high-contrast product, it can be used to expand any part of the tonal range at the expense of both lighter and darker areas; and this is what has been done here

- *With a high-contrast material, the important thing is to know exactly which tones to expand*
- *Polaroid instant-process 35mm films have very tender emulsions and should only be sent out as dupes*

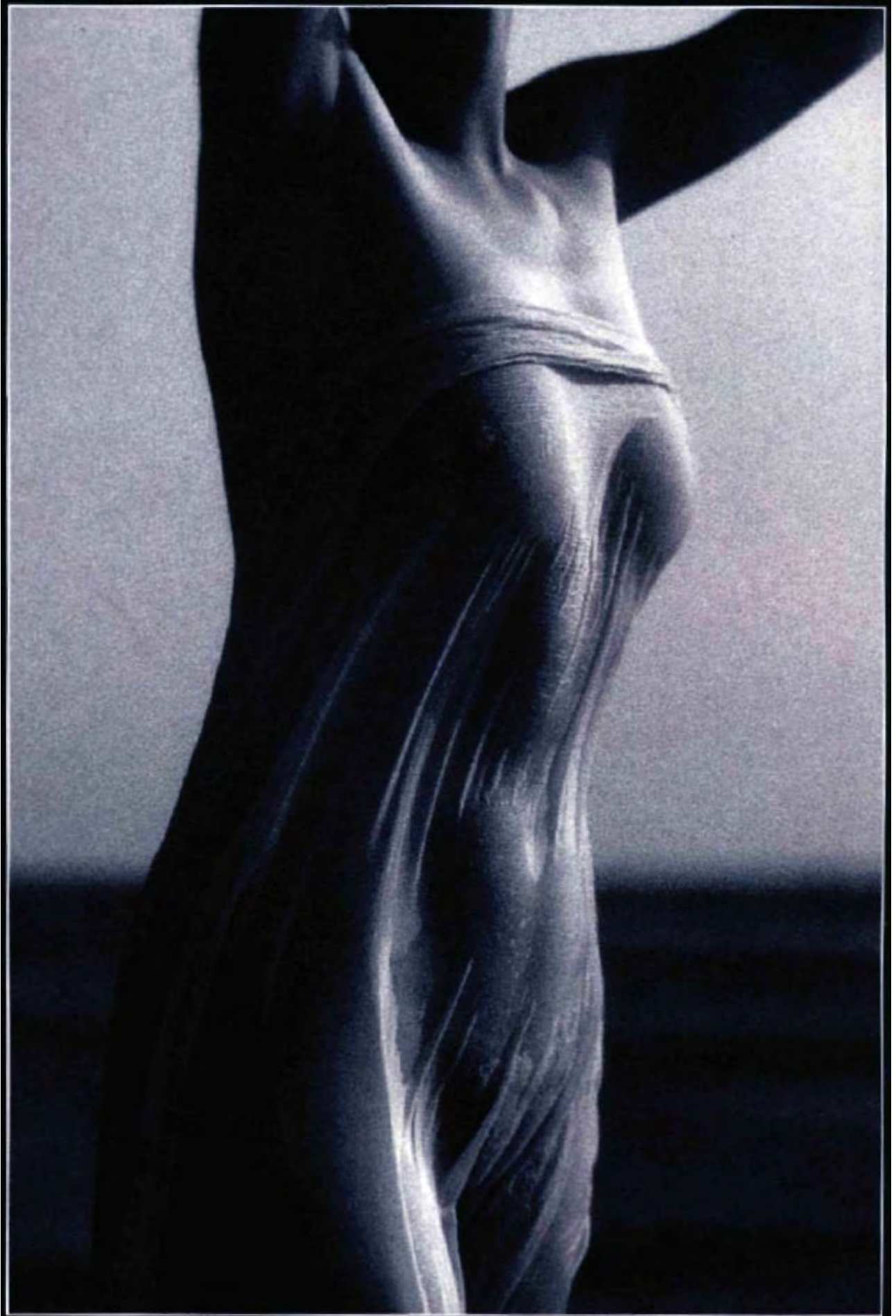



Photographer: **Struan**  
 Use: **Personal work**  
 Model: **Krista**  
 Camera: **35mm**  
 Lens: **105mm**  
 Film: **Kodak Tri-X Pan**  
 Exposure: **1/25 sec at f/4**  
 Lighting: **Available light**  
 Props and set: **White studio wall**

## JEANS

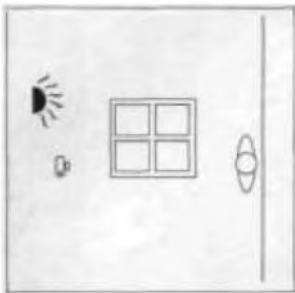

Plan View

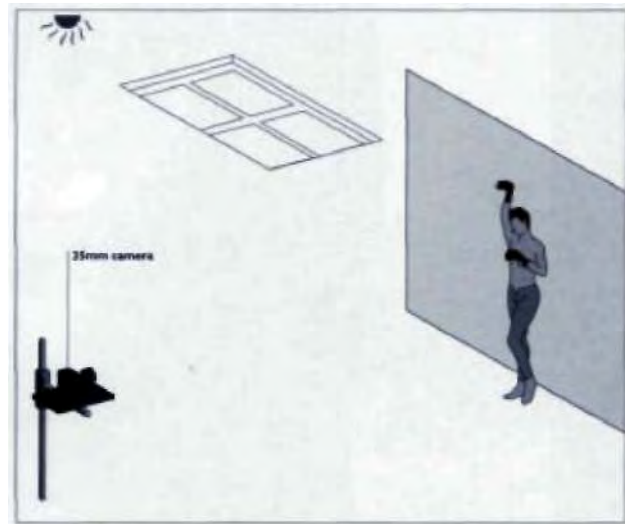

THIS SUCCESS OF THIS PICTURE DERIVES IN LARGE PART FROM ITS PLAYFULNESS. THE MODEL IS DEFINITELY "STRIKING A POSE", BUT THE WOOLLY GLOVES TURN HER INTO A REAL PERSON RATHER THAN JUST A SYMBOL.

Time and again the virtues of our ancestors' daylight studios are revealed: a traditional daylight studio with skylights and blinds is not to be sniffed at. This picture is lit from a skylight on an overcast day.

On the minus side, daylight is less versatile and controllable than artificial light. There are no spotlights, unless it is a

sunny day and the windows are in exactly the right place; you need a large studio, in order to take the greatest advantage of light from different directions; light intensity can vary rapidly as clouds blow across the sun; and light colour can vary widely from warm to cold, necessitating filtration in colour.

- *Daylight is a wonderful medium but hard to control*
- *Because of its colour, north light is often of more use in monochrome than in colour*
- *Contrast what people expect with what they don't expect, for arresting effect*

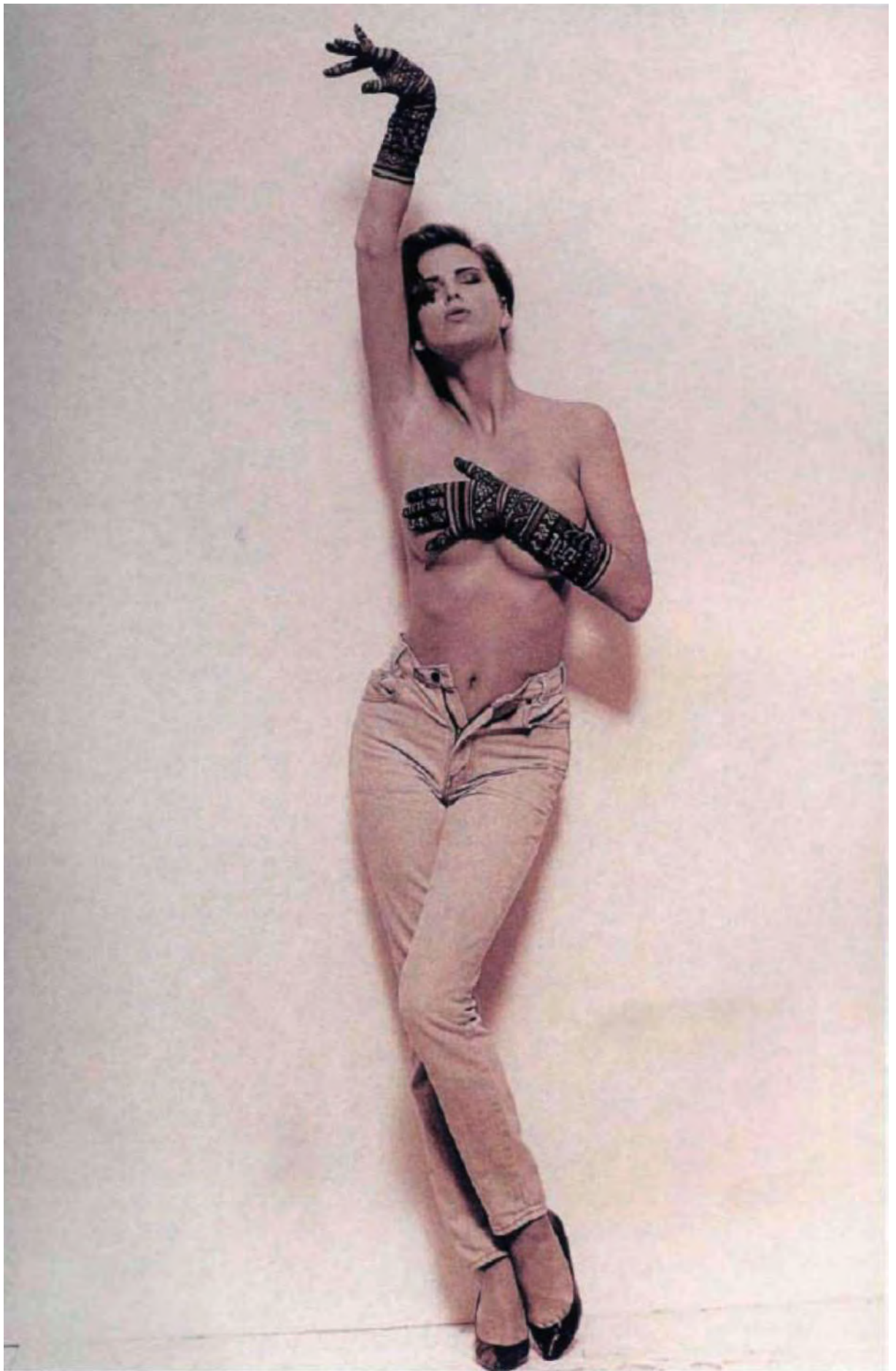



# 2

classical  
nudes



Like many categories in photography, the term "classical nude" defies simple definition. Normally - though far from invariably - the background and setting are both relatively simple, but this simplicity can range from seamless background paper, to the worn floor of a photographer's studio, to a painted fabric background (a very popular choice), to the rugged, rough-finished metal used by Frank Wartenberg. A separate tradition, of which only a single example appears in this chapter, en much more luxurious ambience, though still with simple props: Stu Williamson's *Marie* is very much in the 19th-century style of Alma-Tadema and the other painters of classical scenes.

Traditionally, this is also a field in which lighting is kept fairly simple, because the photographer is often playing with light as much as he (or she) is exploring the graphic possibilities of the nude: half the pictures in this chapter employ only a single light source, and it is not unusual to use two lights together to create the effect of a single, larger light. Rod Ashford's *Kay* uses a single light on the subject, and another on the background.

The majority of pictures in this chapter were shot on roll-film, with about one-third on 35mm and one on 4x5in. For this kind of image, where texture and gradation are at a premium. 35mm may be a less appropriate choice unless (like the photographers whose work is seen here) you have a particular reason to use it.

Photographer: **Mike Dmochowski**

Use: **Self-promotion**

Model: **Dawn (who also acted as stylist)**

Camera: **35mm**

Lens: **150mm + warming filter**

Film: **Kodak Ektachrome EPP**

Exposure: **f/11**

Lighting: **Electronic flash: 2 heads, filtered**

Props and set: **Black velvet/black paper**

## G O L D F E M A L E S C U L P T U R E

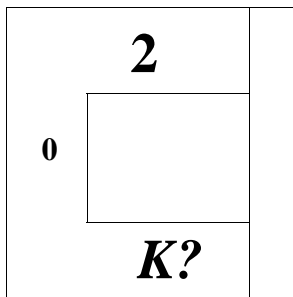

Plan View

WHAT YOU SEE IS WHAT YOU GET: A MODEL PAINTED WITH GOLD BODY-PAINT. WHAT YOU SEE IS ALSO EMPHASIZED WITH THE HELP OF DOUBLE STRAW FILTERS OVER THE LIGHTING AND A WARMING FILTER (VALUE UNRECORDED) OVER THE LENS FOR A REALLY RICH GOLD.

The key light comes from camera left, and is a Fresnel spot about 1.8m (6ft) from the subject and about 60cm (2ft) above the floor. It is at right angles to the line of sight of the camera. The exposure reading, pointing the meter directly at the light source, was f/11.

Fill is supplied by a 1x1 m (40x40in) soft box to camera right, directly opposite the key and about 1.2m (4ft)

from the model. The exposure reading from this light, again pointing the meter straight at the light from the position of the model, was f/5.6-1/2 (f/6.8). The model is on black velvet, with a black seamless paper sweep behind her the velvet is more illuminated than the paper, but it reflects about 1 stop less light and so reads as completely black

- *Gold body-paint smears very easily and can be difficult for a model to apply evenly all over*
- *Strong warming filters such as an 81Ef can be extremely effective with golden subjects of any kind*
- *There is no truth in the rumour (which originates from a James Bond movie) that gold body-paint is dangerous when applied all over. It can be worn for many hours without any risk*

### Photographer's comment:

Exposure is very subjective in this sort of picture. My preference would be for a dark exposure, but unlike a lot of subjects where exposure is critical, on this there was at least a 3-stop latitude.

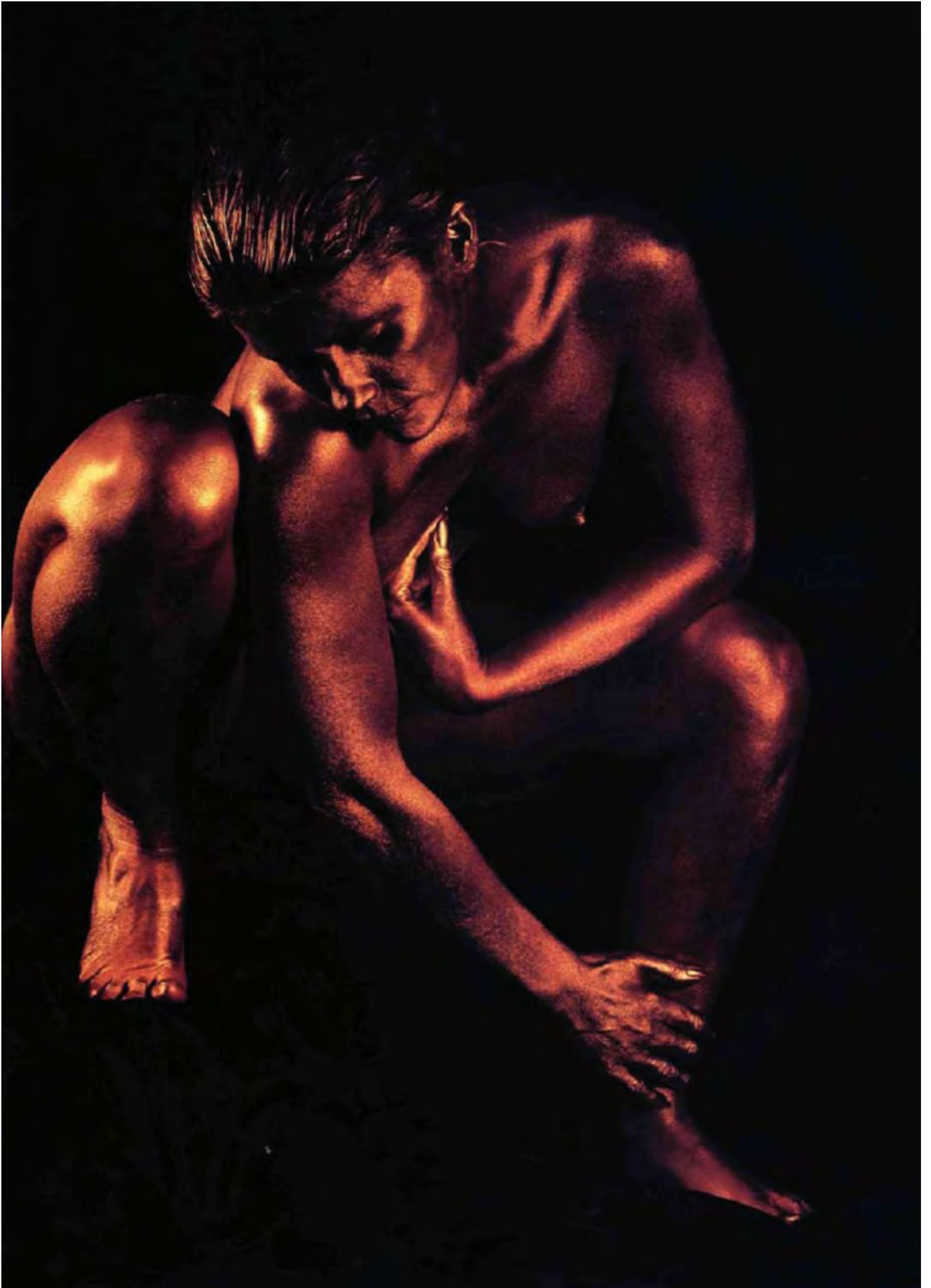

Photographer: **Stu Williamson**  
 Client: **Marie**  
 Use: **Portfolio shot for modelling**  
 Camera: **6x7cm**  
 Lens: **140mm**  
 Film **Ilford FP4 Plus**  
 Exposure: **f/11**  
 Lighting: **Electronic flash: three heads**  
 Props and set: **See text**

**M A R I E**

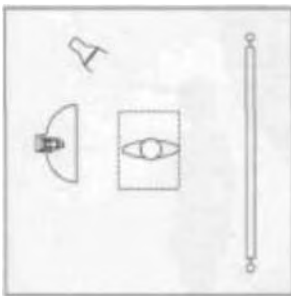

Plan View

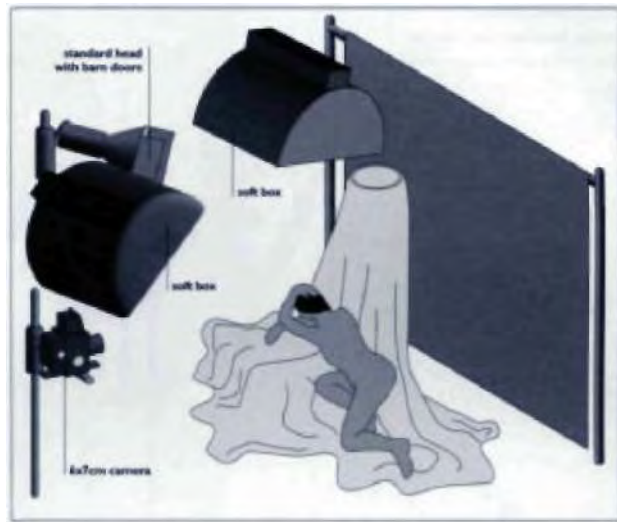

THERE ARE MORE THAN OVERTONES OF 19TH-CENTURY ODALISQUES IN THIS PICTURES; IT IS REMINISCENT OF THE PAINTINGS OF ALMA-TADEMA, WHO WAS FAMOUS FOR HIS VOLUPTUOUS MAIDENS IN CLASSICAL OR EXOTIC SETTINGS.

The key light is from above, almost directly over the model and to her right. The effect is of sunlight streaming through a window. A soft box in front of the model, just above the camera, provides fill. A third light, a standard head with barn-doors, illuminates the background.

The hanging, veil-like material was specially made up by a wedding supply

store. It is sewn to a hoop of the kind typically carried by bridesmaids and decked with flowers; as the photographer somewhat unromantically says, "It is like an enormous mosquito net" This hangs in front of a Colorama painted background. To complete the 19th-century effect, the picture was printed through a "Craqueleur" texture screen.

- *Photographers can often learn as much from painters as they can from other photographers*
- *Lighting, pose and props are all complemented by the texture screen*
- *Dramatic chiaroscuro characterizes many seraglio scenes*

**Photographer's comment:**

The texture screen is made in the United States and used to be imported into the UK. by my father through his business, World Wide Promotions.

Photographer: **Kay Hurst, K Studios**

Use: **Portfolio**

Model: **Catherine Richardson**

Camera: **4x5in**

Lens: **360mm**

Film: **Polaroid 55 P/N at EI 25**

Exposure: **Not recorded**

Lighting: **Electronic flash: one head**

Props and set: **White background paper**



Plan View

## ELEGANCE



THE LIGHTING IS SIMPLE: A BROAD REFLECTOR ("BOWL AND SPOON") TO CAMERA LEFT, CLOSE TO THE MODEL. YOU CAN WORK THIS OUT FOR YOURSELF FROM THE SHADOWS AND FROM THE LACK OF EXTRA BACK LIGHTING.

The large (90cm/3ft) "bowl and spoon" gives a "hotter" light than a soft box, especially when used close to the subject, as here. The overall effect of the image is, however, much influenced by the afterwork.

The image was printed onto Kentmere Art Classic, which was then sepia toned,

colour photocopied and transferred onto Fabriano Canaletto natural art paper; after treatment with a suitable solvent, the colour copy was burnished down onto the paper. By varying the pressure a solarized effect can be created in the black areas: the pre-treatment is necessary in order to achieve this effect.

- *Quality of light is easier to recognize than to describe, but it is much affected by reflector size and degree of diffusion*
- *Processes such as this are highly idiosyncratic and may require considerable experiment with different papers, toners, photocopiers and transfer papers*





Photographer: **Frank Wartenberg**

Use: **Portrait**

Camera: **6x7cm**

Lens: **350mm + light blue filter**

Film: **Fuji Velvia**

Exposure: **f/5.6**

Lighting: **Mixed: 5 heads (see text)**

Props and set: **Blue painted canvas backdrop**

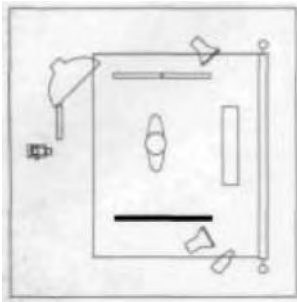

Plan View

## BLUE

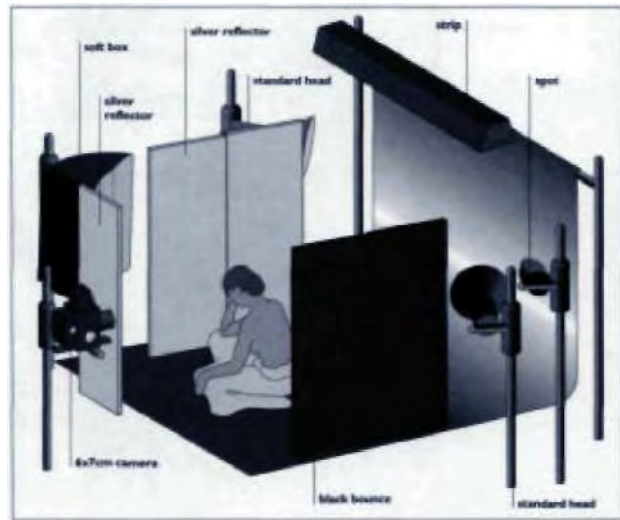

WEAK BLUE FILTRATION ON THE CAMERA LENS AND A BLUE BACKDROP ARE NOT THINGS THAT WOULD OCCUR TO EVERYONE AS BEFITTING A CLASSICAL NUDE; BUT THE RESULT IS A CURIOUSLY EFFECTIVE COMBINATION OF COLDNESS AND WARMTH.

- *Textured canvas creates a mood very different from plain background paper*
- *Evenly illuminating a background can require a great deal of light*
- *The "negative space" around the model creates a good deal of the mood of the picture*

The key light is a large soft box to camera left, with silver reflectors on either side. The soft box is clearly directional but the big silver bounces on either side of it throw back blue-tinted spill from the other lights to create the illusion of a still larger source. To camera right, large black bounces ensure that the shadow side (the model's back) is as dark

as it can be. The remaining lights - two standard flash heads, an overhead strip light, and a daylight (HMI) spot - all combine to illuminate the background fairly evenly but with a small darker area in the upper left to provide a little more variation than comes from the painted canvas alone.

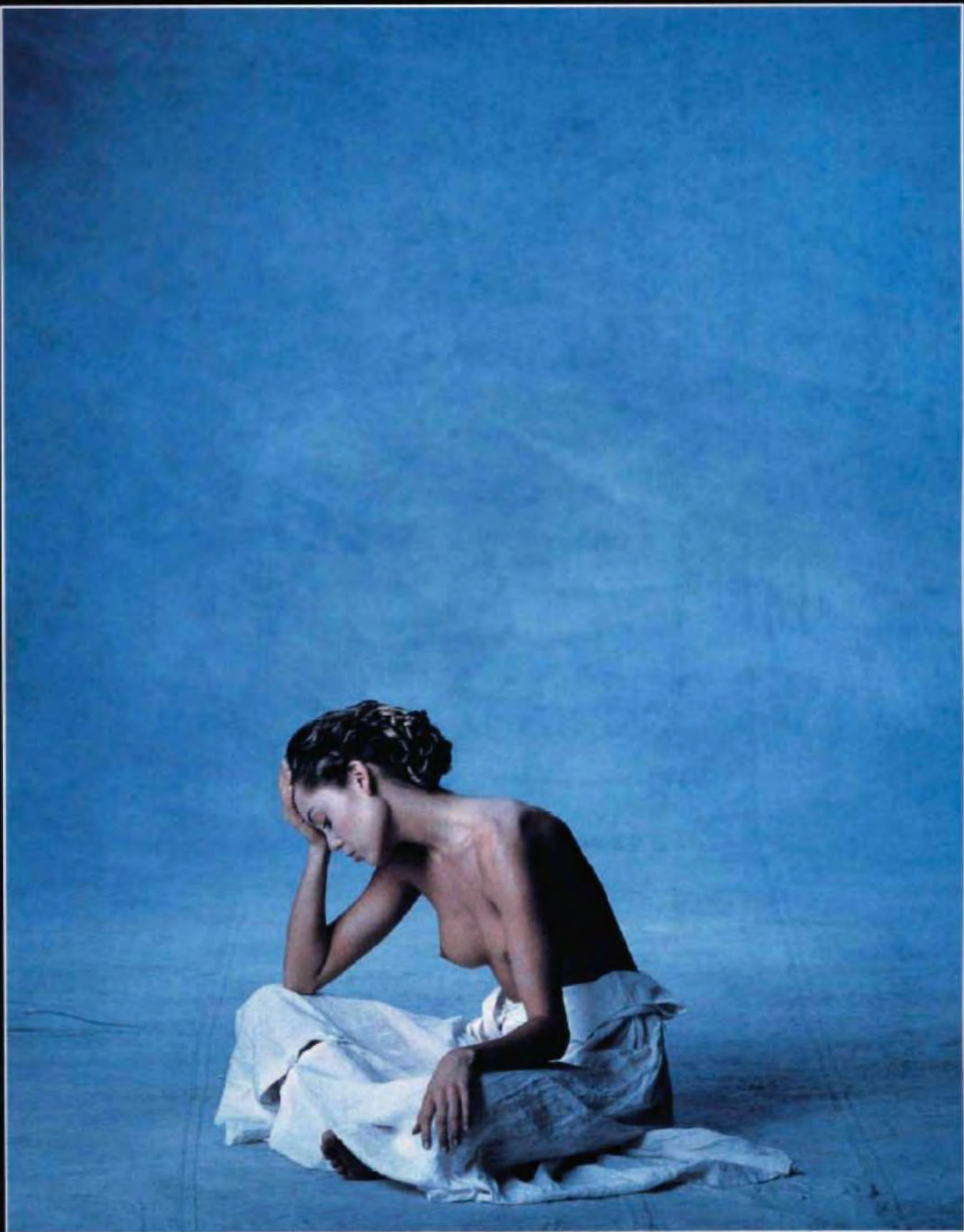

Photographer: **Frank P. Wartenberg**

Use: **Portfolio**

Camera: **RB67**

Lens: **Not recorded**

Film: **Not recorded**

Exposure: **Not recorded**

Lighting: **Daylight plus HMI spot**

Props and set: **White seamless background**

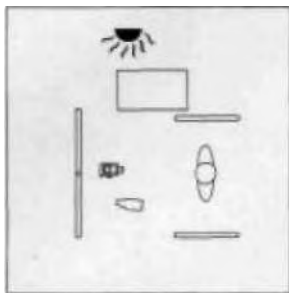

Plan View

## HIGH KEY

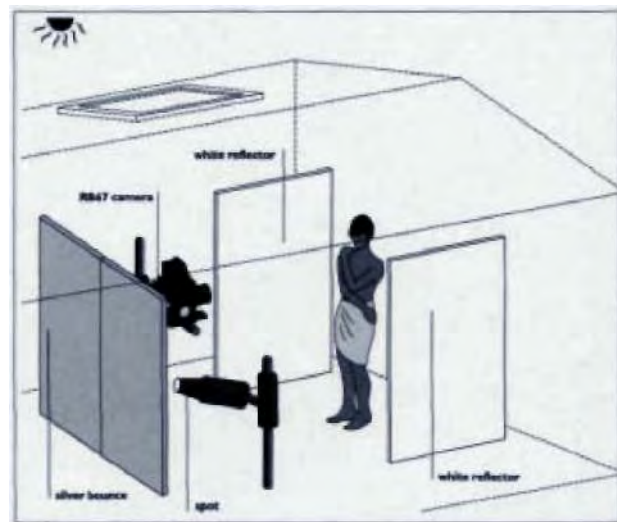

MUCH OF THE POWER OF THIS PICTURE COMES FROM THE MODEL'S DIRECT, CHALLENGING STARE: THE MOOD IS AT ONCE EROTIC AND HUMAN, RATHER THAN DEPERSONALIZING THE MODEL INTO AN EMPTY FANTASY.

Unusually, this was shot in a daylight studio: a large roof window provided the fill. Although such studios are rare today, and although the windows must be capable of being covered when they are not needed, a true daylight studio can be remarkably versatile, as our Victorian ancestors repeatedly demonstrated.

Here, though, the daylight was supplemented by a daylight (HMI) spot bounced off two big silver bounces over the top of the camera to create a very flat, classically high-key light. Two large white reflectors, one on either side of the model, completed the high-key set-up.

- *Normally - though not invariably, as seen here - there are small areas of maximum black even in a high-key picture*
- *The background in a high-key picture is almost invariably lighter than the subject*
- *Generous use of large bounces is commonplace in high-key photography*



Photographer: **Frank P. Wartenberg**  
 Use: **Portfolio**  
 Camera: **6x7cm**  
 Lens: **185mm with deep blue filter**  
 Film: **Kodak Ektachrome EPT tungsten balance**  
 Exposure: **Not recorded**  
 Lighting: **Large soft box**  
 Props and set: **Ground metal**

## BLUE METAL

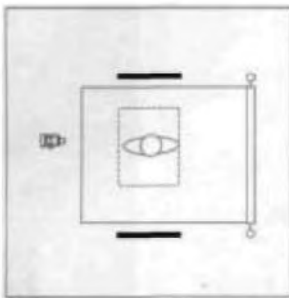

Plan View

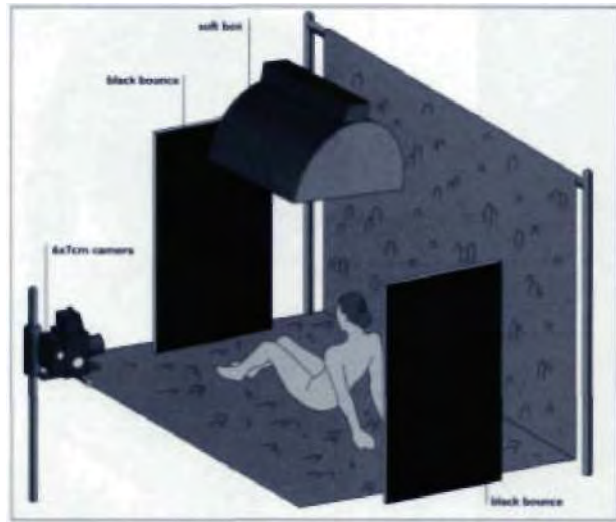

THE SET IS DRAMATIC IN ITS OWN RIGHT: ROUGHLY WORKED METAL. THIS IS NOT THE MOST COMFORTABLE SURFACE TO SIT ON! To ADD TO HER DISCOMFORT, THE MODEL WAS COVERED WITH SILVER MAKE-UP. THE OVERALL EFFECT IS HOWEVER VERY MEMORABLE.

- *In addition to its colour, make-up can greatly affect the reflectivity of skin*
- *Sometimes two separate paths have to be pursued in order to create an intense effect; in this case, blue filtration and the use of tungsten-balance film with daylight-balance lighting*

Tungsten-balance film with daylight-balance flash makes for a very blue image, which is further enhanced here with a deep blue filter. A big soft box is suspended over the model, which explains the shadows: in effect, only the upper part of her body is illuminated, though there is some fill from the reflected light off the background. The flash-back from the background itself

bums out the area around the model, creating a semi-silhouette effect. Painting the model silver may seem curious in the context of a blue picture, but the simple truth is that even the matte silver which is normally attained with make-up is significantly more reflective than normal skin. This is what adds the apparent very high contrast to the figure.



Photographer: **Stu Williamson**  
 Client: **Correna**  
 Use: **Model portfolio**  
 Camera: **6x7cm**  
 Lens: **105mm**  
 Film: **Kodak Plus-X Pan**  
 Exposure: **f/8**  
 Lighting: **Electronic flash: one spot**  
 Props and set: **Lastolite hand-painted background**  
**background**

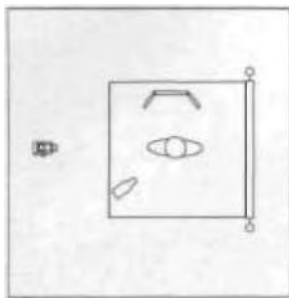

Plan View

## CO R R E N A

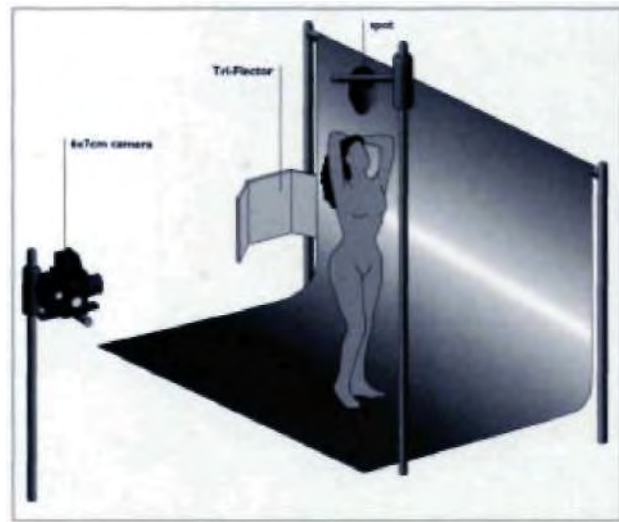

THIS IS THE SORT OF PICTURE WHICH ANY AMATEUR PHOTOGRAPHER COULD TAKE - GIVEN A BEAUTIFUL GIRL, A SPOTLIGHT, AN OFF-THE-SHELF BACKGROUND, ENOUGH TALENT AND A PAINSTAKING ATTENTION TO DETAIL.

- *If there is insufficient room between the model and the background, consider making a feature of the model's shadow*
- *If you want a shadow, it is often best to use the hardest light available to you*
- *Many photographers use a "palette" of films for different effects*

It shows that rules are made to be broken - the "rule" in this case being that the model should be a long way from the background so that she casts no shadow. If you are going to break a rule it is often as well to break it thoroughly: Stu used a very hard light to cast a clear, strong shadow which echoes the model's

shape on the background. A "Tri-Flector" (see page 24) provides some fill, The light is very high over the camera, as can be seen from the shadow, and the light is harsh; and yet the modelling is exquisite. The choice of Plus-X Pan, an "old technology" film, allowed maximum control of tonality in development.

### Photographer's comment:

The picture was toned using Fotospeed Sepia toner.





Photographer: **Rod Ashford**  
 Client: **Professional Photographer magazine**  
 Use: **Review of toners; subsequently used as book cover in Norway**  
 Model: **Kay Holmes**  
 Hair/Make-Up: **Sandra Ashford**  
 Camera: **35mm**  
 Lens: **70-210mm**  
 Film: **Ilford FP4 Plus**  
 Exposure: **f/16**  
 Lighting: **Electronic flash: 2 heads**  
 Props and set: **Painted background by Fantasy Backgrounds, Eastbourne**

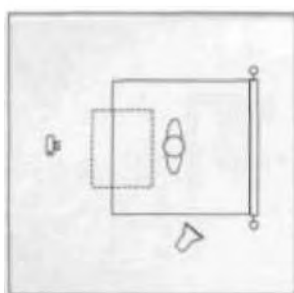

Plan View

## KAY

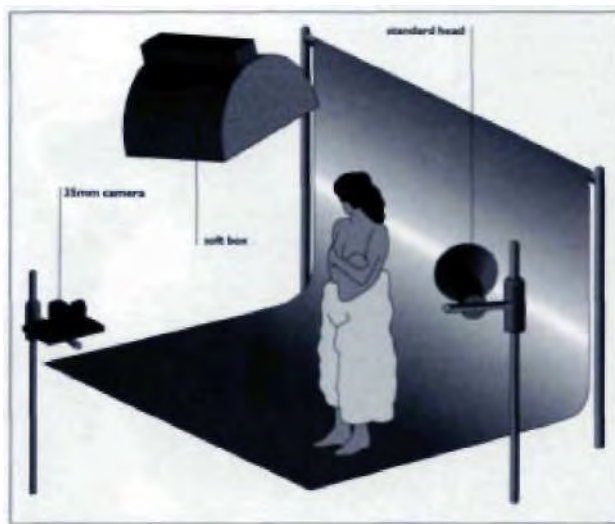

WHEN MOST MAGAZINES TEST TONERS, THEY USE BORING SHOTS FROM THEIR FILES. PROFESSIONAL PHOTOGRAPHER HIRED A REAL PHOTOGRAPHER WHO CAN ALSO WRITE, AND GOT HIM TO TEST COLORVIR TONERS IN REAL-WORLD CONDITIONS.

- *As with many of the monochrome pictures in this book, this one owes a great deal to the printer (who was also the photographer)*
- *With split toning and "freeze grey", a neutral grey can appear warm toned when contrasted with a cold blue*

Rod used two lights, a 40x50cm (16x20in) Photoflex Litedome soft box and a standard head. The standard head was used as a background light, while the soft box was the key and only light on the model; as can be seen from the shadows, it was high above the camera and very slightly to the left. Both lights, he notes, were Bowens Esprit units, which he particularly likes.

Contrary to immediate appearances, the background light was not snooted or tightly honeycombed behind the model's head. There was some gradation, but it was much enhanced in printing and then further enhanced (somewhat to the photographer's surprise) by the toning chemistry: a brief dip in "freeze grey" held the highlights, followed by blue toning for the shadows.

### **Photographer's comment:**

The model, Kay Holmes, had contacted the editor of the magazine, asking how to become a model. He referred her to me, and this was from the very first session.

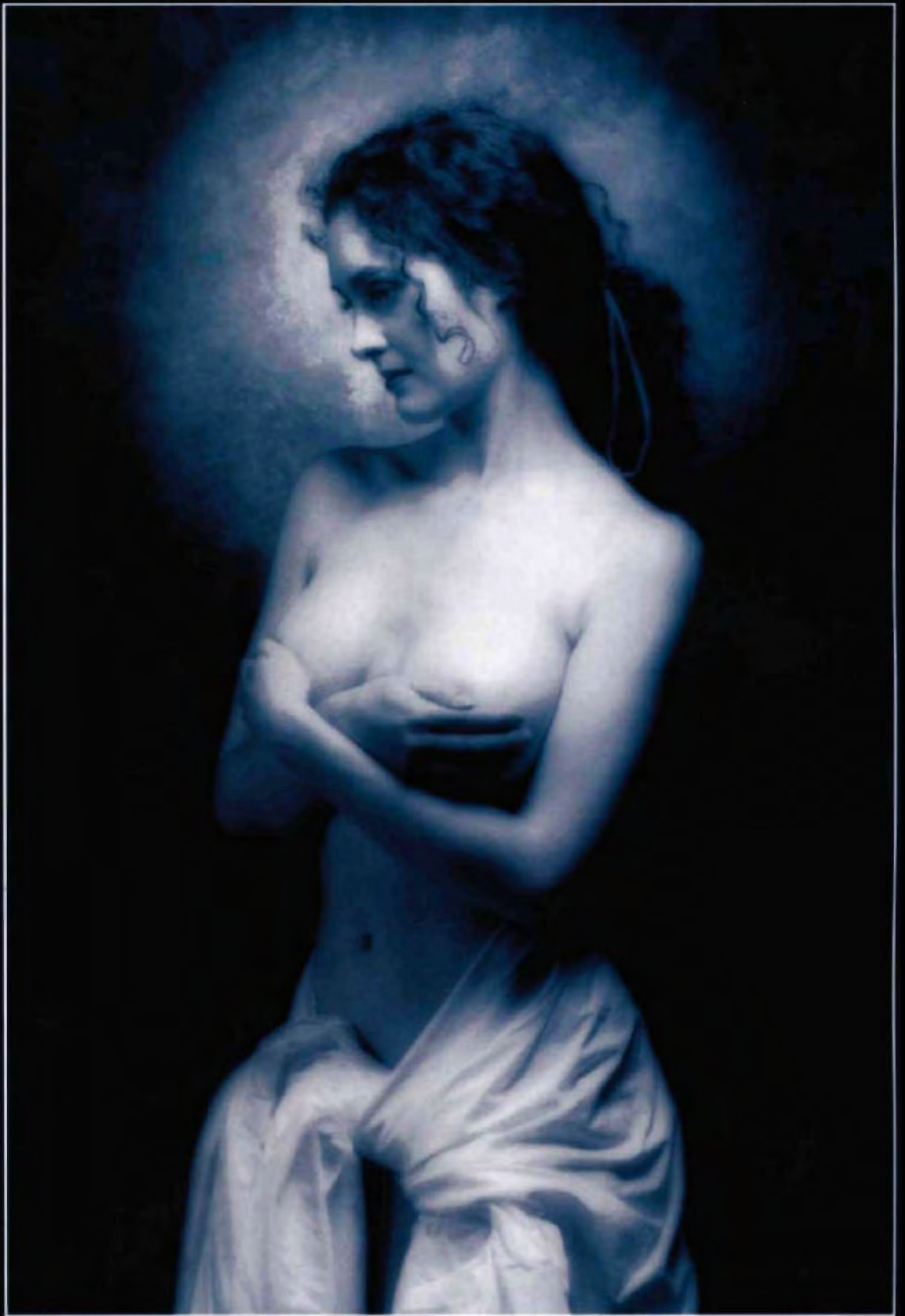

Photographer: **Frank P. Wartenberg**

Use: **Portfolio**

Camera: **6x7cm**

Lens: **185mm**

Film: **Agfa Scala**

Exposure: **Not recorded**

Lighting: **Large soft box**

Props and set: **Ground metal**

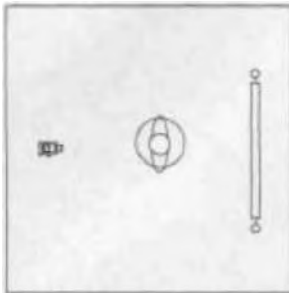

Plan View

## SILVER



THIS PICTURE CLEARLY ILLUSTRATES THE RELATIONSHIP BETWEEN HIGH CONTRAST AND HIGH KEY. IN ONE SENSE, THE TWO ARE QUITE DIFFERENT; AND YET IN ANOTHER, EFFECTIVE HIGH KEY DEPENDS ON EFFECTIVE HIGH CONTRAST.

Also, there is a great deal of difference between a picture with a full tonal range, but where the main interest lies in the extremes of tone, and one which lacks mid-tones and is reduced to 'soot and whitewash'. Controlling contrast means controlling lighting.

Here the sole light is a big soft box which is suspended over the model. She is painted silver in order to bring her reflectivity up to that of the background.

Roughly equal (and high) reflectivities of subject and background are one of the essential requirements of a high-key picture. In effect, only the upper part of her body is illuminated, though the highly reflective rough-ground metal background provides fill. Choice of film was important: the long tonal range of a transparency film allows more subtlety, more easily, than using a print film.

- *With long tonal ranges, a low-contrast material is essential*
- *With high-contrast materials, low-contrast lighting is essential if you want a good tonal range*
- *Compare this with the picture on page 55, which is lit the same way but uses colour transparency film*

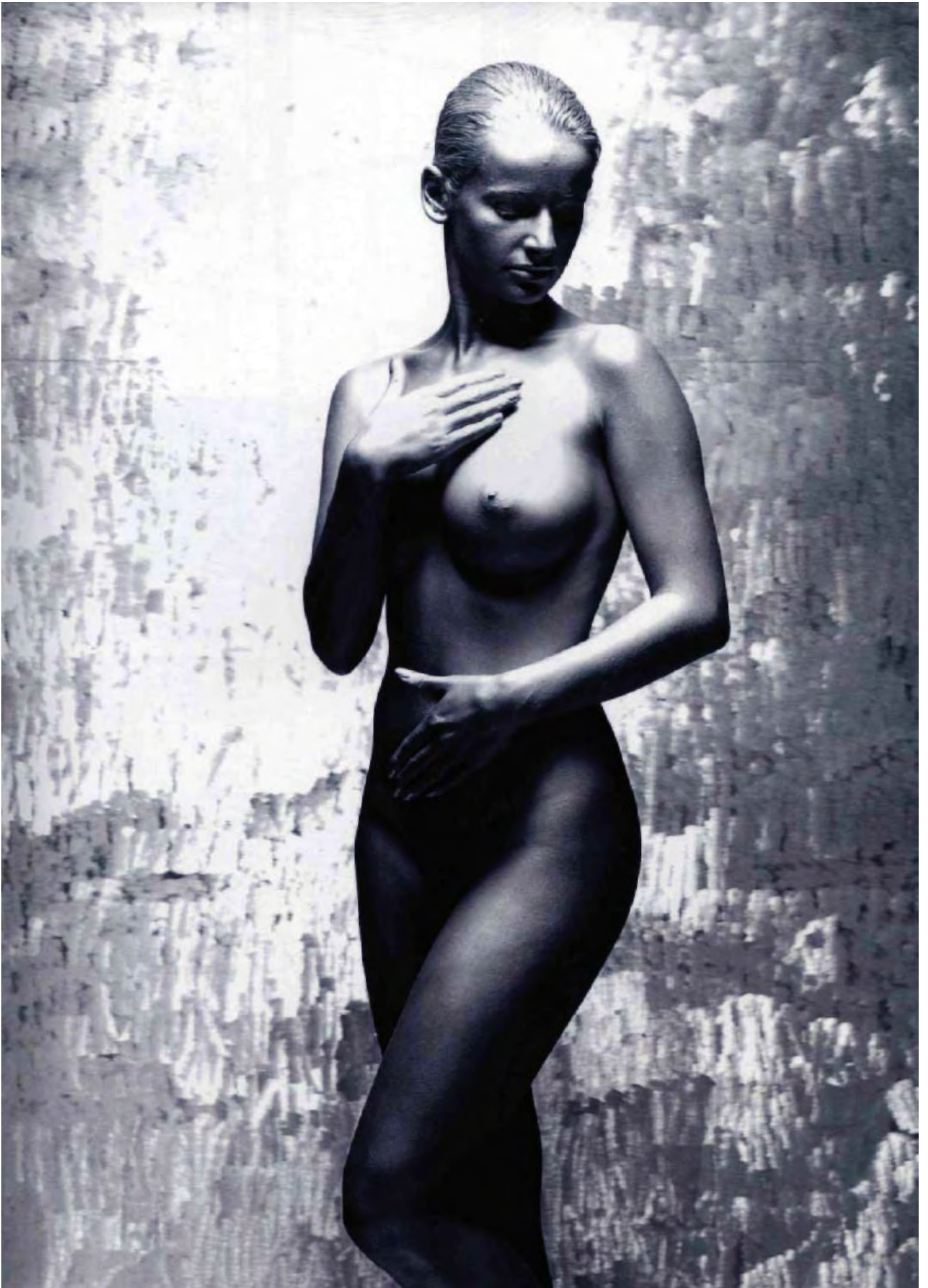



3 the  
semi-domestic  
nude

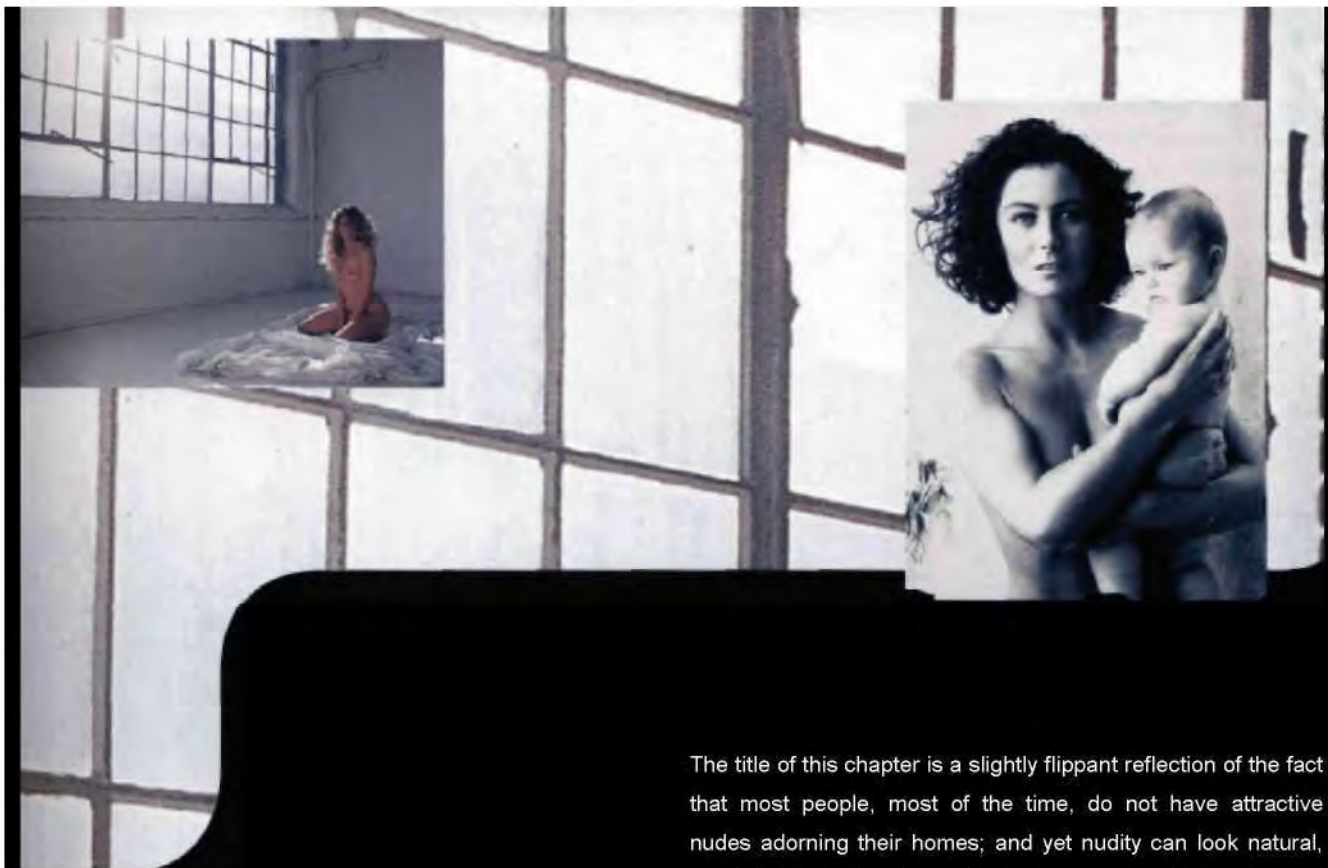

The title of this chapter is a slightly flippant reflection of the fact that most people, most of the time, do not have attractive nudes adorning their homes; and yet nudity can look natural, or slightly but attractively risqué, in a range of domestic and semidomestic settings.

Inevitably, the definition has been stretched: Frank Wartenberg's *Nude with Chair* is photographed against a plain fabric backdrop, but was included because it is essentially a picture which could have been taken at home; Terry Ryan's *Mother and Child* is a studio picture taken against a white background which is included because of the implications of domesticity inherent in motherhood. Often any picture in any chapter in this book could as well be assigned to another chapter; but as long as the pictures are attractive in themselves it is more important that they are included, rather than that they should precisely reflect the title of the chapter.

There is a wide variety of lighting, from daylight (used in half the shots in the chapter) through a single artificial light source to complex set-ups, particularly in *Morning Tea* from Jordi Morgadas, where the "bedroom" is actually a built set with big soft boxes outside the windows. In general, it must be said, daylight is harder to handle than it looks and such subterfuges as white furnishings (see Peter Barry's *Room*) are needed to even out the light.

Photographer: **Jordi Morgadas**  
 Client: **Penthouse Magazine**  
 Use: **Editorial**  
 Model: **Karin**  
 Make-up: **Susana Munoz**  
 Stylist: **Maria Rowen**  
 Camera: **35mm**  
 Lens: **85mm with A-2 filter**  
 Film: **Kodak Ektachrome EPR ISO 64**  
 Exposure: **f/16**  
 Lighting: **Electronic flash: 3 heads**

## MORNING

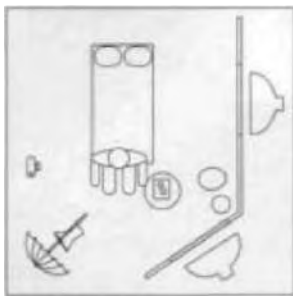

Plan View

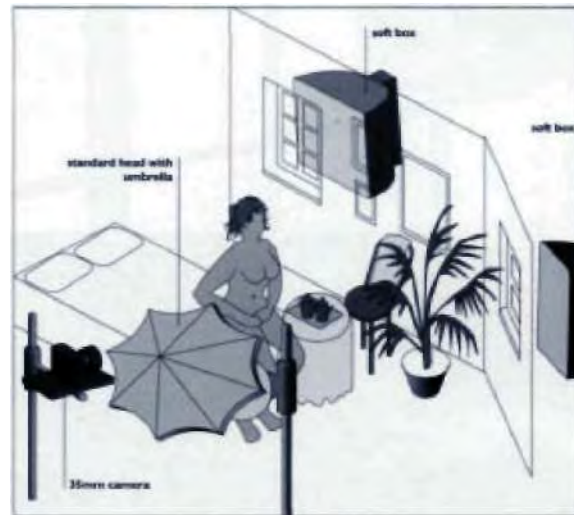

THE BUILT SET, WITH SOFT BOXES SHINING THROUGH WINDOWS, IS A MORE COMMON PLOY THAN MOST AMATEURS IMAGINE: IT GIVES THE PROFESSIONAL THE MAXIMUM POSSIBLE CONTROL, WITHOUT WORRYING ABOUT WEATHER OR TIME OF DAY.

Here there are two "windows", one of which is in shot and the other of which is clearly implied by the light from camera right. Both are transilluminated by large soft boxes, each 100x200cm (40x80in), and they create the many highlights on the model.

If these had been the only lights, however, there would have been very little rendering of the exquisite skin textures, and the drapes of the table

beside the bed would have been flat and lifeless. A giant 2m (80in) umbrella to camera right therefore provided what is arguably the key light, although it is only marginally so because the overall lighting ratio is so tight. This picture clearly demonstrates that quality of light - directionality or harshness - can define which light is a key and which are fills or effects lights.

- *Very large umbrellas can be a convenient alternative to soft boxes for some applications*
- *Tight lighting ratios can still exhibit a surprising degree of modelling if one light is very diffuse and the other is more directional*





Photographer: **Struan**  
 Client: **Amanda**  
 Use: **Portrait**  
 Camera: **35mm**  
 Lens: **35mm**  
 Film: **Kodak Ektachrome EPN ISO 100**  
 Exposure: **1/125sec at f/8**  
 Lighting: **Available light**  
 Props and set: **Large daylight studio**

## A M A N D A

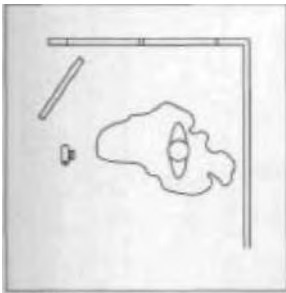

Plan View



MODERN STUDIOS OFTEN BEAR MORE RESEMBLANCE TO A FACTORY THAN TO A 19TH CENTURY ARTIST'S A *TEUBR*. SOME PHOTOGRAPHERS PAINT THEIR WINDOWS BLACK OR OTHERWISE BLOCK THEM PERMANENTLY, WHILE OTHERS FIT BLINDS TO ALLOW THE OPTION OF DAYLIGHT.

- *Silver (and gold) reflectors are much more directional than white*
- *Different films have different responses to wide lighting ratios*
- *A white sheet can have numerous uses*

Here, sunlight is supplemented by a 120x 120cm (4x4ft) silver movie-type reflector to camera left. One might have expected another reflector to be to camera right to provide fill on the side away from the window, but the white interior of the studio took care of this. Besides, this is a much more directional reflector than a white bounce: you can see the secondary shadow behind the model on the wall. Its purpose is to fill

the front of the model: without it, the choice would be between wildly overexposing the sunlit portions, or underexposing the model. The model is kneeling on a white sheet, almost one of Struan's trademarks; he always carries a few white sheets with him, as props, backgrounds, reflectors, screens for the model to change behind, and so forth.

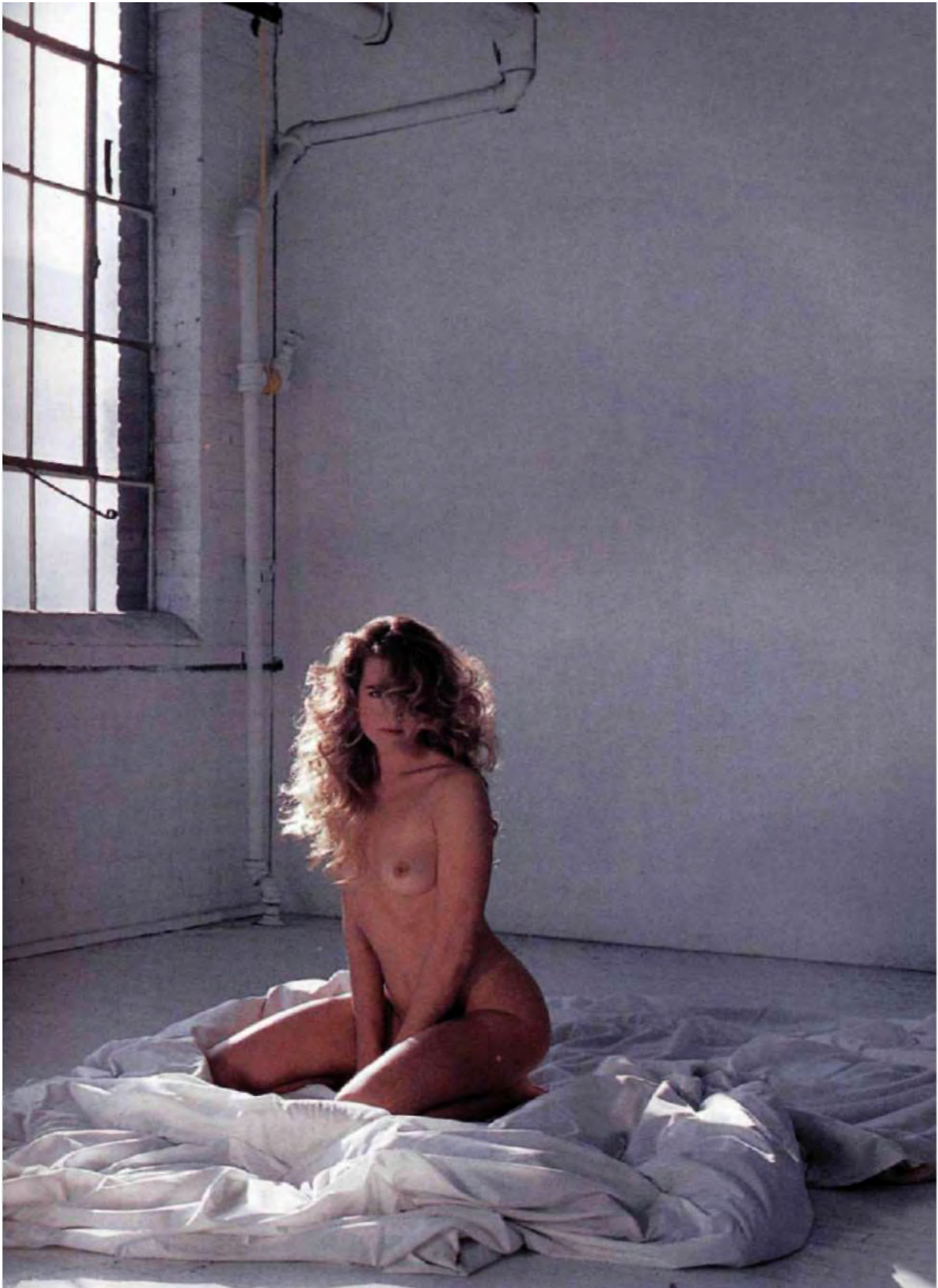

Photographer: **Peter Barry**

Use: **Model test**

Camera: **6x6cm**

Lens: **80mm**

Film: **Kodak Ektachrome EPR ISO 64**

Exposure: **1 Msec at f/4**

Lighting: **Available light**

Props and set: **Location**



Plan View

## RO OM



THE LIGHTING HERE IS SO SMOOTH, AND THE MODELLING SO GOOD, THAT IT IS HARD TO BELIEVE THAT IT IS "ONLY" AVAILABLE LIGHT. BUT THERE IS MORE HERE THAN MEETS THE EYE...

- *Do not neglect the possibilities of manipulating blinds and curtains to control "available" light*
- *Over-exposure would "blow" the highlights, but under-exposure would not give adequate skin tones*
- *The tiptoe pose and outstretched arm of the model echo the vertically of the blind*

Two important factors are the vertically slatted window blinds and the light-coloured chair and cushions behind the model. The slatted blinds can create a surprisingly directional light, and they can also be angled so that the direction can be controlled. These two factors together help to explain a great deal of the success of the photograph.

Exposure is critical and a film of relatively low contrast is needed if the highlights are not to burn out and be "blown"; some modern films would be too contrasty to handle this sort of tonal range. Also, extreme neutrality is needed: some films run slightly blue, others slightly magenta, and, with flesh tones and light highlights, colourcasts would soon become very obvious.



Photographer **Terry Ryan**

Use: **Self-promotion**

Model: **Amanda Benson**

Camera: **35mm**

Lens: **105mm**

Film: **Polaroid Polagraph 400**

Exposure: **f/16**

Lighting: **Electronic flash: 1 head**

Props and set: **White background paper**

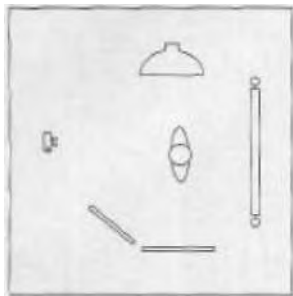

Plan View

## M O T H E R   A N D   C H I L D

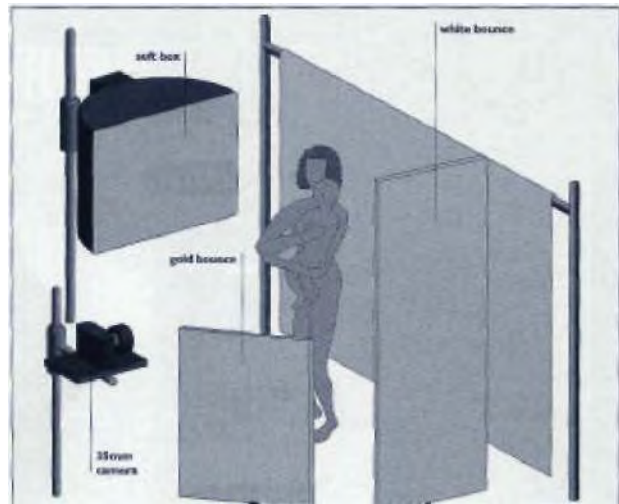

POLAROID'S ISO 400 POLAGRAPH FILM IS DESIGNED FOR TECHNICAL USE, BUT TERRY RYAN HAS DEVELOPED CONSIDERABLE EXPERTISE IN EXPLOITING ITS UNIQUE TONALITY FOR GENERAL PHOTOGRAPHY. THE SECRET LIES IN A VERY TIGHT LIGHTING RATIO AND EXTREMELY CAREFUL EXPOSURE.

The only light here is a big "swimming pool" soft box to camera left, but immediately to camera right there is a big white bounce - a 120x240cm (4x8ft) sheet of expanded polystyrene - and a gold bounce as well. The background, which looks burned out and high-key, as if it were illuminated separately, is in fact very close to the model and is lit only by spill from the key light.

A problem with all Polaroid emulsions is that they are very, very tender and easily scratched, so it makes sense to 'duplicate them immediately and never to send out originals to clients. In this case the scratches and the processing artifacts (the marks around the edge of the image) are presented as a part of the image - as though it were an old picture that had been rediscovered.

- *H/g/7-contrast films require very tight lighting ratios*
- *Lighting backgrounds with spill is not always easy*
- *Flaws and marks can be an integral part of a picture*

### Photographer's comment:

This shot was taken whilst working on a shot for Boots the Chemist pic It was decided to use Polagraph, and although a series of shots was taken, the effect on this particular frame - the borders, etc - seemed to me to add that extra something to the shot.

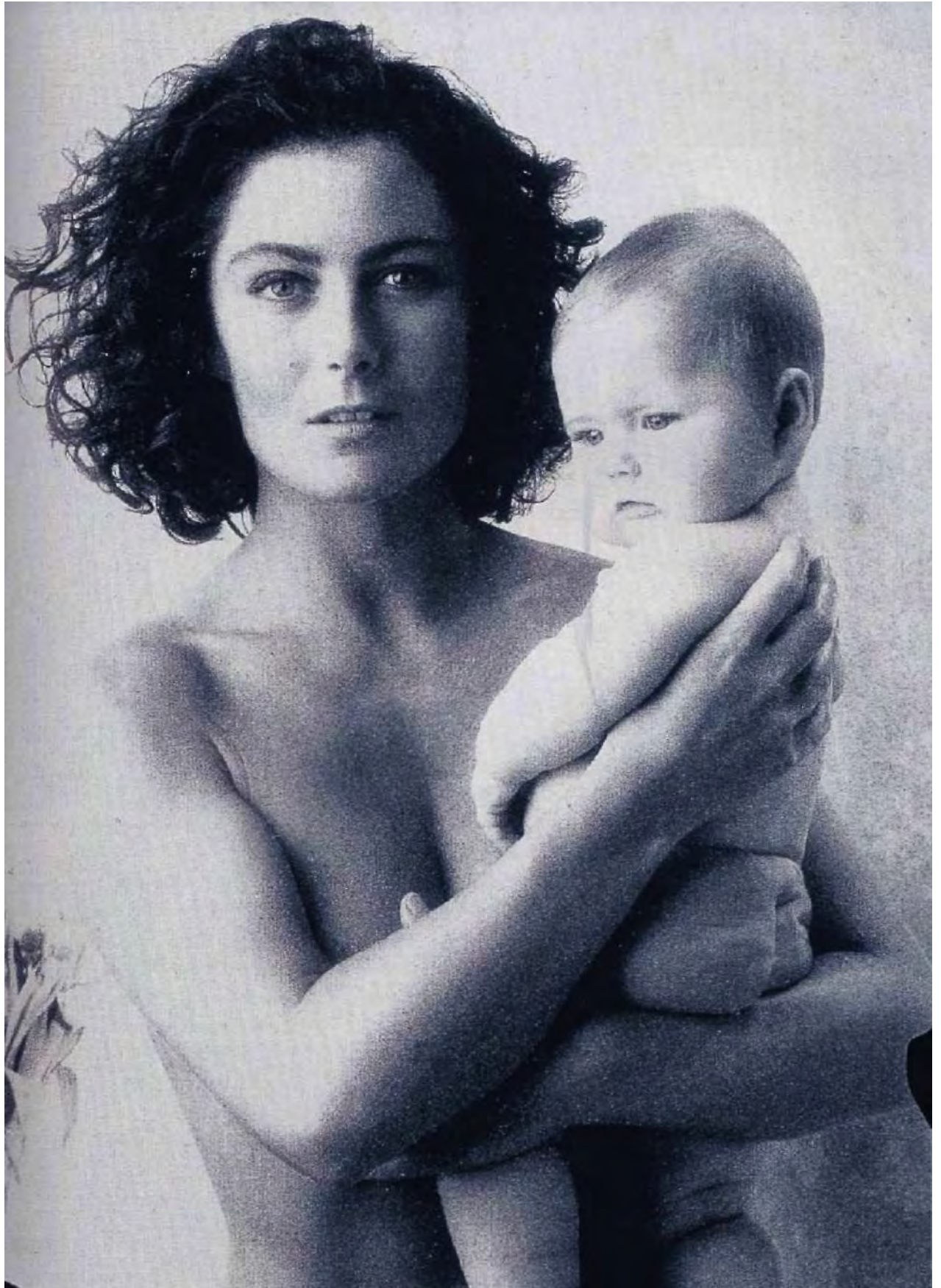

Photographer: **Struan**  
 Use: **Personal work**  
 Model: **Lorraine**  
 Camera: **35mm**  
 Lens: **50mm**  
 Film: **Kodachrome 64**  
 Exposure: **f/11**  
 Lighting: **Electronic flash: 3 heads**  
 Props and set: **Bath, tile flats**

## RED BATH TUB

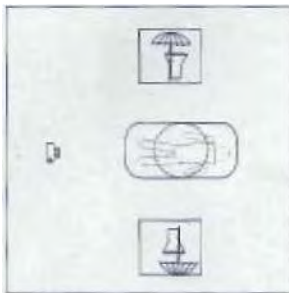
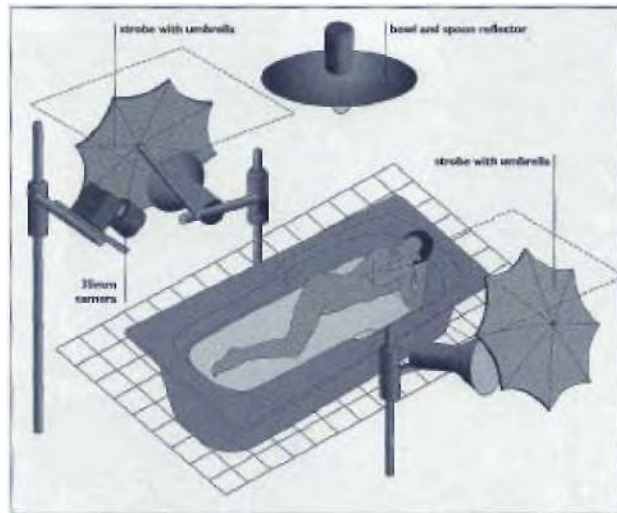

Plan View

STRUAN SAYS: "WE HAD HIRED THE BATH-TUB FOR A BUBBLE-BATH SHOT, AND AS IT WAS IN THE STUDIO, I WANTED TO TRY SOME MORE SHOTS WITH IT. IF YOU HAVE PAID FOR IT, YOU MIGHT AS WELL USE IT."

- *Vivid colours sometimes speak for themselves, but they can also be enhanced by skillful lighting*
- *Portrait (vertical) compositions are often more energetic than landscape (horizontal)*

He continues: "We bought a couple of sheets of 240x120cm (8x4ft) tile board for the "floor". There's a single light over the top - my big, circular reflector, 90cm (3ft) across - and then there's a strobe on either side with an umbrella to light the tiles, I tried it without but there was too much shadow beside the bath." The big round reflector creates the

highlights on the model and (even more importantly) on the bath, and choosing Kodachrome really "pops" the red - Kodachrome is famous for its reds.

Baths are normally shot "landscape", which emphasizes their stability and restfulness. Adopting the unusual technique of shooting from one end gives a much more energetic composition.

### Photographer's comment:

I shot this on both 35mm and with the Hasselblad; the Hasselblad shot won second prize in a national Hasselblad contest



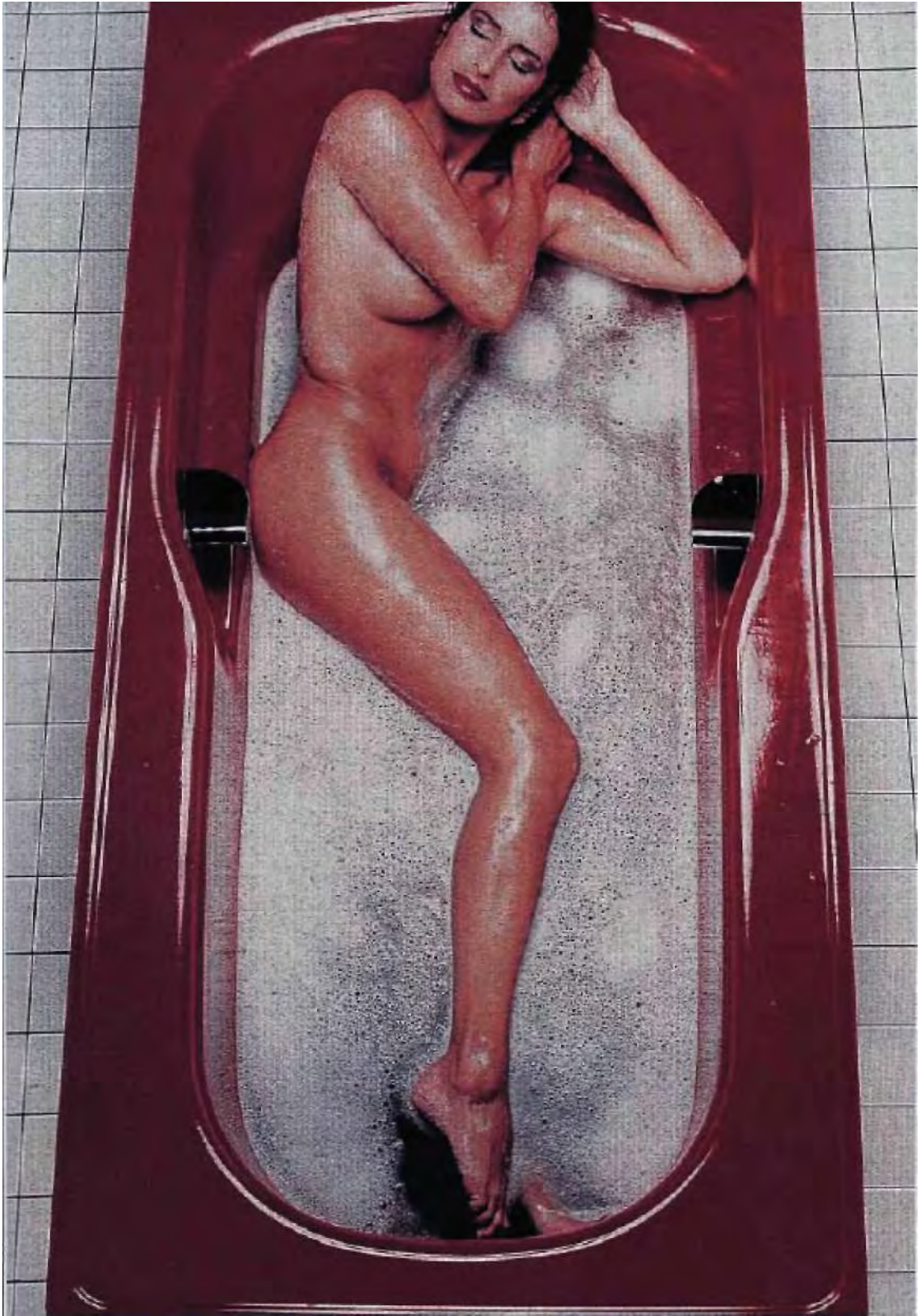

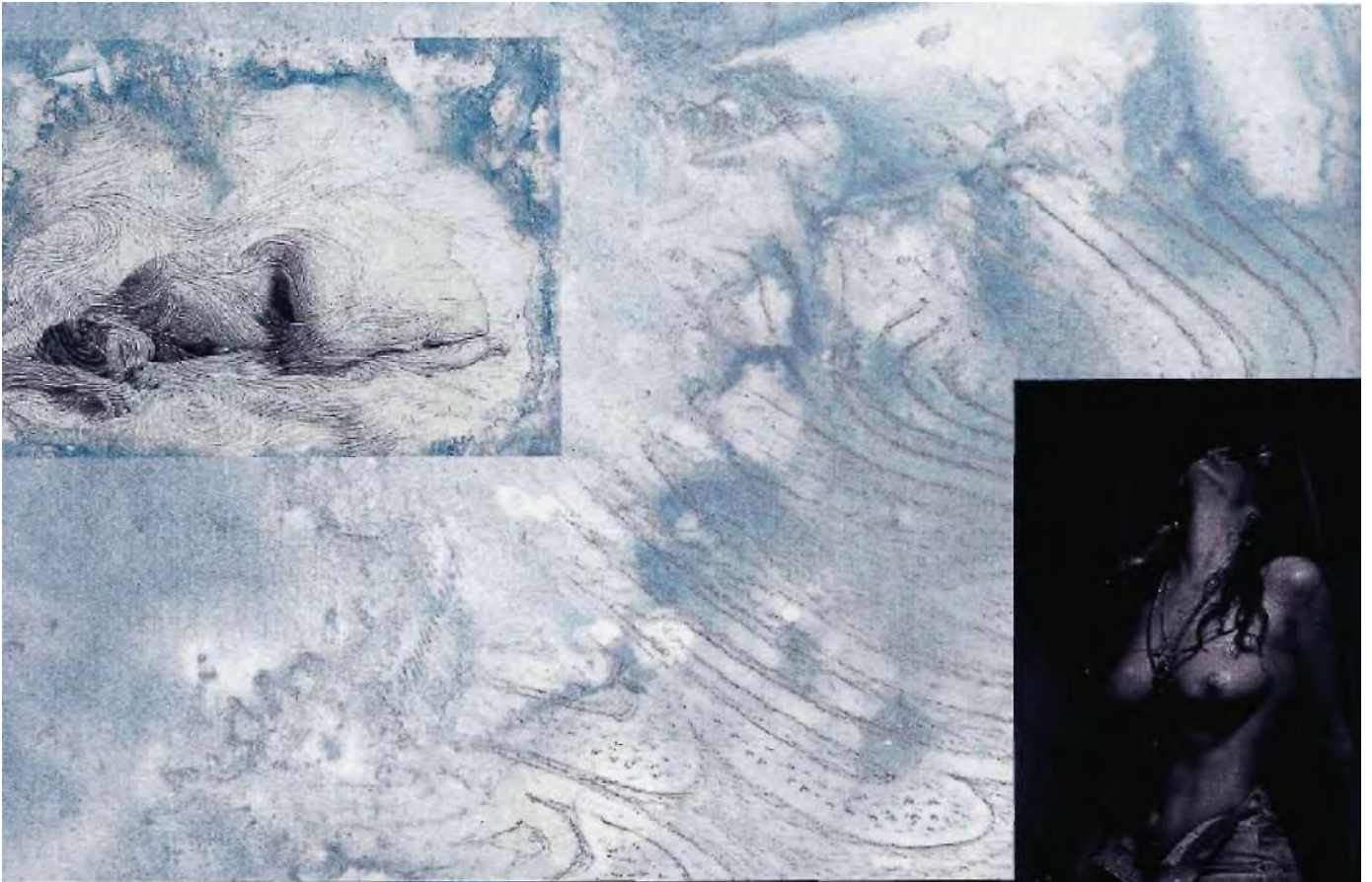

4

fantasies



The pictures in this chapter run from the gentlest of fantasies - Struan's Sylvia, for example - through more radical visions such as Gunter Uttendorfer's No Name to the stuff of dreams and nightmares. In some the camera is simply made to lie, while preserving its ostensible realism. In others, the idiosyncracies of the photographic process, or the possibilities for manipulation during printing, are the secret. Yet others are simply straight shots: the secret lies in the set-up (and, of course, in the lighting).

Some are definitely disquieting, while others are curiously tranquil; and which ones seem disquieting to a particular person, and which ones seem tranquil, will depend very much on that individual's outlook on life. All illustrate the necessity of

learning to meld vision and technique, as either on its own is insufficient: far too many pictures are spoiled by an absence of one or the other, so that a good idea is poorly realized or faultless execution betrays a woeful lack of aesthetic feeling.

Rollfilm and 35mm are neck and neck, with one 4x5in shot. It is particularly interesting to compare two superficially similar pictures, Stu Williamson's Vicky and Gunter Uttendorfer's No Name, to see how technically and stylistically different they are - as well as to see that on closer examination, the content and pose of the two pictures differ considerably more than they at first seem.

Photographer: **Harry Lomax**

Use: **Promotional card**

Model: **Jo**

Camera: **4x5in**

Lens: **65mm and 360mm**

Film: **Fuji RDP ISO 100**

Exposure: **f/16 double exposure: see text**

Lighting: **Flash: see text**

Props and set: **Dragon "set"; girl on seamless paper**



Second Exposure

## DRAGON

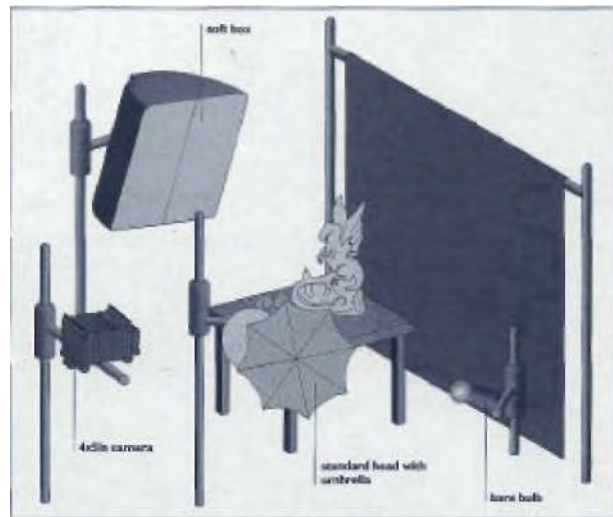

ELECTRONIC IMAGE MANIPULATION IS SO COMMONPLACE NOWADAYS THAT WE MAY FORGET HOW A GOOD PHOTOGRAPHER CAN OFTEN OBTAIN BETTER RESULTS, FASTER AND MORE ECONOMICALLY, USING TRADITIONAL PHOTOGRAPHIC TECHNIQUES. THIS IS A DOUBLE EXPOSURE.

The dragon "set" is a sculpture less than 30cm (12in) high, with a foreground of moss and pebbles and a graduated background. The key light is a big soft box to camera left, very slightly back lighting the subject, while fill comes from an umbrella to camera right set one stop down from the key. A bare bulb behind and below the dragon differentiates the background. The area to be occupied by the girl is masked off and marked on the

ground glass. This was shot with a 360mm lens. The girl was then shot through a "keyhole" screen so that only she recorded on the film, the rest going black. The lighting was similar- a soft box to camera left, an umbrella to camera right and a bare bulb behind her - but lighting distances were adjusted to compensate for the fact that she was shot with a 65mm lens in order to get the scale right

- *Switching focal lengths is a useful way to control image size in a multiple exposure, provided perspective is not a problem*
- *When switching focal lengths, the relative distances of lights and subject may need to be changed to maintain consistent lighting - although the orientations should remain as constant as possible*

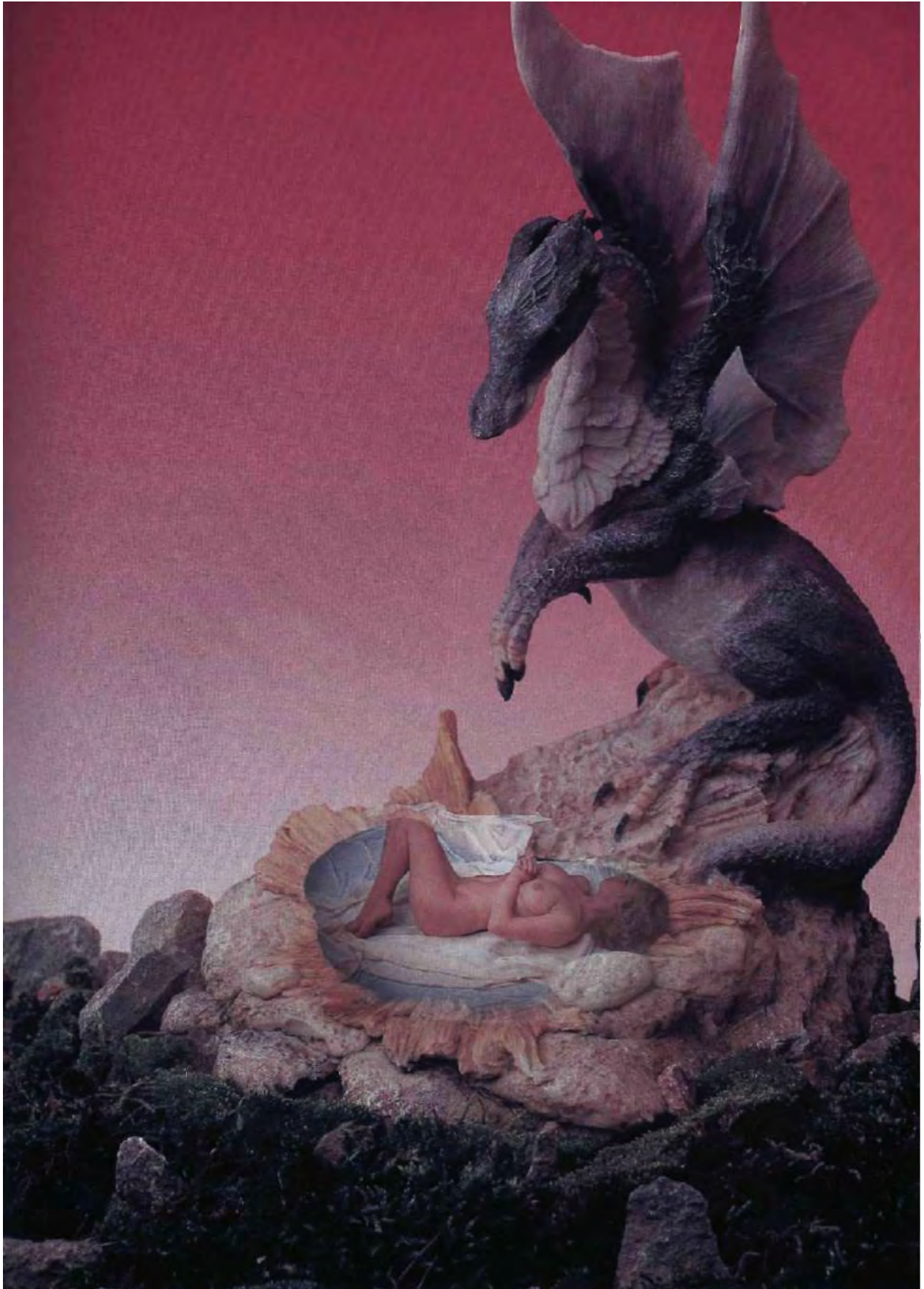

Photographer: **Benny De Grove**  
 Use: **Exhibition**  
 Assistant: **Astrid van Doorslaer**  
 Stylist: **An De Temmerman**  
 Camera: **6x6cm**  
 Lens: **150mm**  
 Film: **Kodak T-Max ISO 400**  
 Exposure: **f/8**  
 Lighting: **Electronic flash**  
 Props and set: **Painted background;**  
**rope**



Centre Panel

## RELATIONS

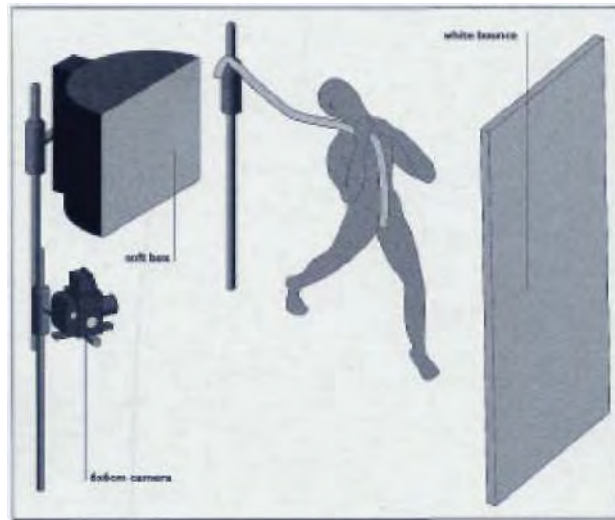

THE TRIPTYCH IS AN UNUSUAL FORM IN PHOTOGRAPHY, BUT IN THIS CASE IT SOLVED A TECHNICAL PROBLEM AS WELL AS MEETING AN AESTHETIC REQUIREMENT. THE TRIPLE PANEL (PREVIOUS PAGE) IS THE TRIPTYCH OPEN; THE DOUBLE PANEL (OPPOSITE) IS THE SAME THING CLOSED.

Making the picture in one shot was not possible: the tension of the rope and the sheer scale of the picture made this impracticable. It was therefore shot as two images, one of the man and one of the woman. Both were lit with a single 80x80cm (32x32in) soft box to camera left, supplemented by a white bounce to camera right in the case of the woman; the woman pulling in the other direction

(towards camera right) is merely a flopped image of the woman pulling towards camera left, so the same image is used in effect four times, twice right-way-around and twice flopped.

Getting the level of the rope precisely right in the picture of the man was the most difficult part: it had to match with the level of the rope in the other two pictures.

- *Like any other form of composite image, a triptych must be internally consistent in its lighting*
- *The triptych form allows pictures which would otherwise require more studio space than is available, and also allows supports, etc., to be used out of shot but in the middle of the picture*
- *Although the traditional form of the triptych is in folding "icon" style like this, there is no reason why it has to be*

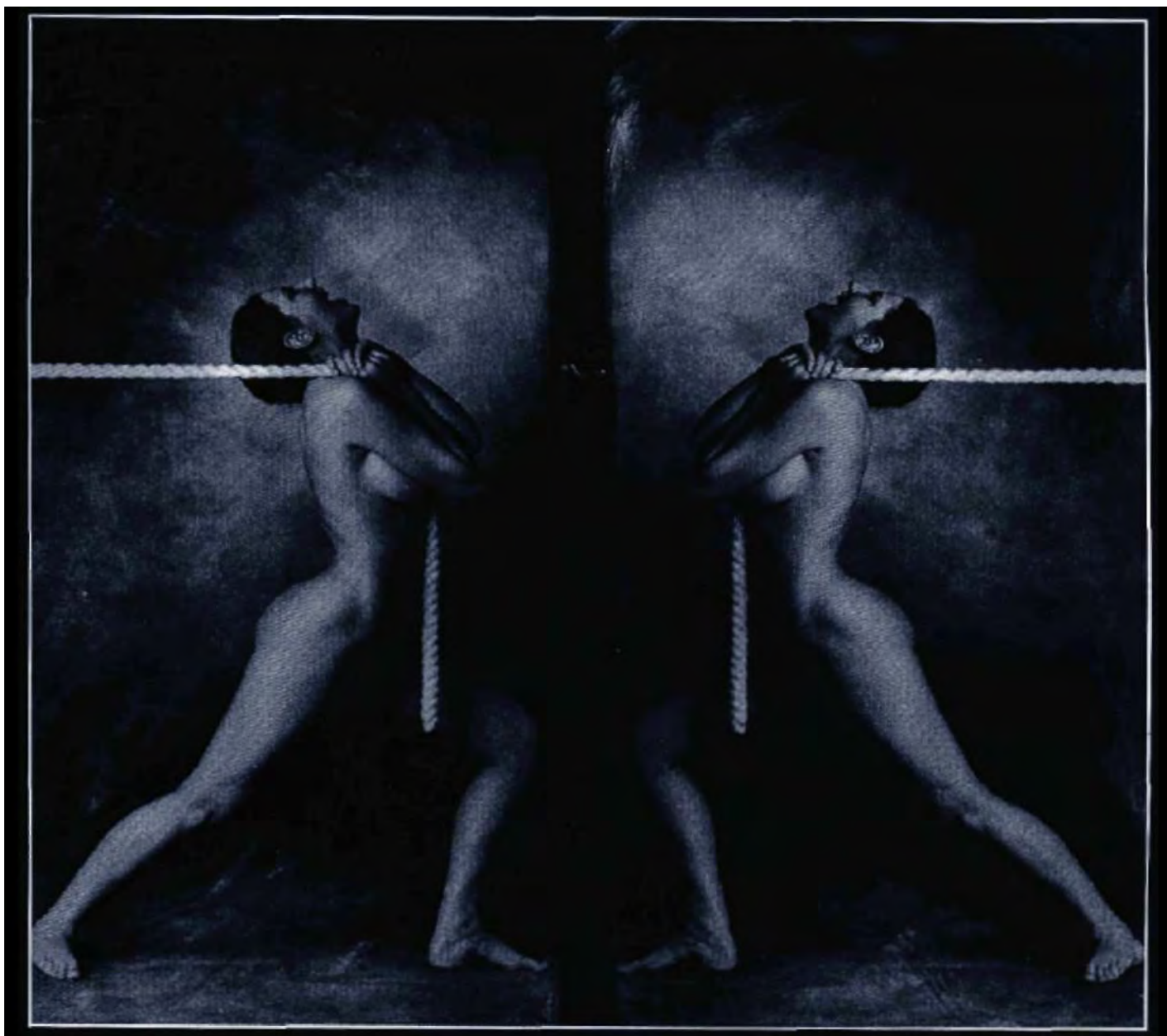

Photographer: **Giinther Uttendorfer**  
 Client **Mogges Chair Factory**  
 Use: **Poster**  
 Model: **Svetlana Hassanin**  
 Assistant: **Jiirgen Weber**  
 Stylist: **Genevieve Hawtry**  
 Art director: **Florian Lehner**  
 Camera: **35mm**  
 Lens: **55mm**  
 Film: **Polapan 35**  
 Exposure: **Not recorded**  
 Lighting: **Electronic flash: 2 heads**  
 Props and set: **Built set: metal sheeting, chains, water spray**

## NO NAME

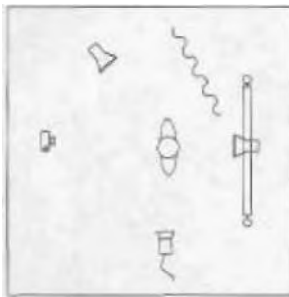
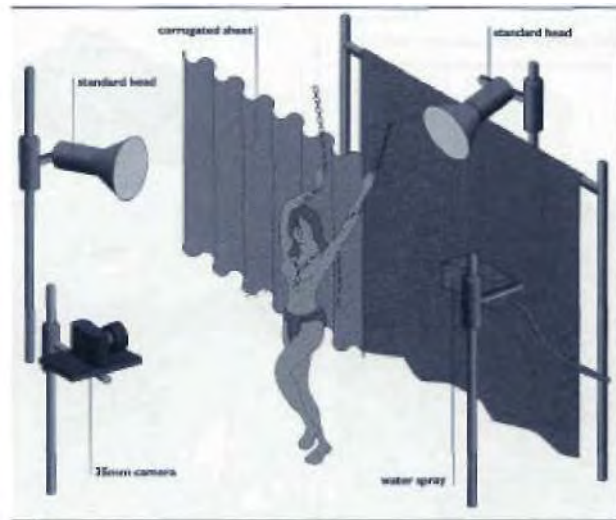

Plan View

THIS WAS SHOT AS AN IMAGE-POSTER FOR ONE OF MY CLIENTS. THEY HATED THE IDEA OF NORMAL, STERILE, PREDICTABLE ADVERTISING - SO WE DECIDED TO SHOOT SOMETHING DIFFERENT, SOMETHING MORE LIVELY."

- *Modern studio flash units typically have a flash duration of 1/300 to 1/800sec, which will not fully "freeze" spraying water*
- *The tonality of Polaroid Polapan has a Hollywood quality to it*

There are only two lights, a 500 Joule unit to camera left at about 45° to the line of sight and about 2m (6ft) from the model, and another 500 Joule unit back lighting the model (and the water spray) some 4m (13ft) from the model. Both lights are set above the model's eye line, the key only slightly above and the back light well above. The key light has a

standard head with a honeycomb and a frost, whereas the back light has barn doors and a frost.

The set is built of galvanized corrugated iron sheeting and black fabric. Clearly, when mixing water and electronic flash, considerable care must be taken to avoid the risk of potentially fatal shock.

### Photographer's comment:

- Most of the time I use direct lighting with standard reflectors, honeycombs and frost filters.



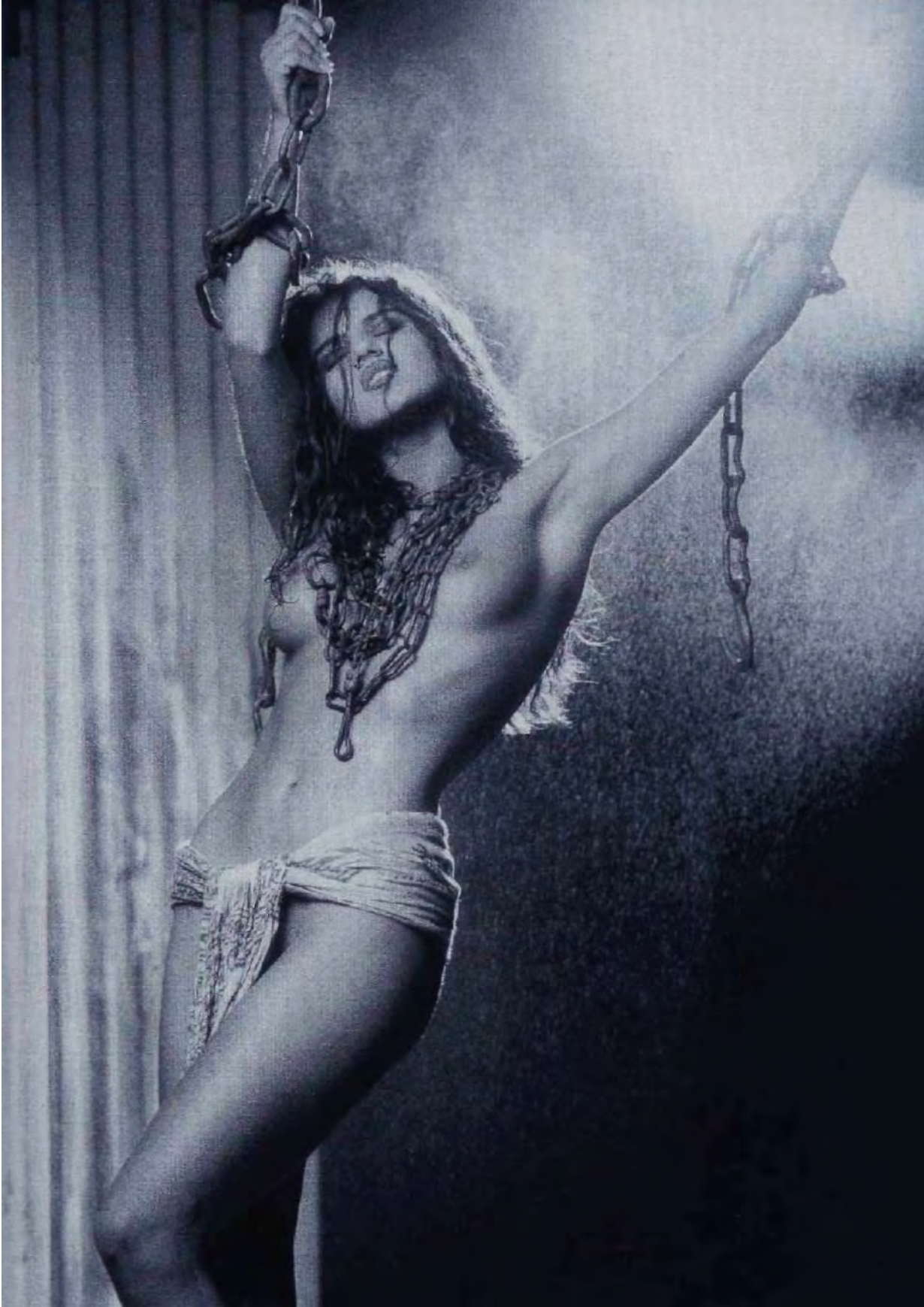

Photographer: **Stu Williamson**  
 Client: **Vicky**  
 Use: **Model portfolio**  
 Camera: **6x7cm**  
 Lens: **105mm**  
 Film: **Ilford Pan F**  
 Exposure: **f/11**  
 Lighting: **Electronic flash: 2 heads**  
 Props and set Rope: **Lastolite hand-painted background**

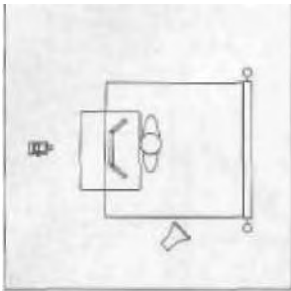

Plan View

## VICKY

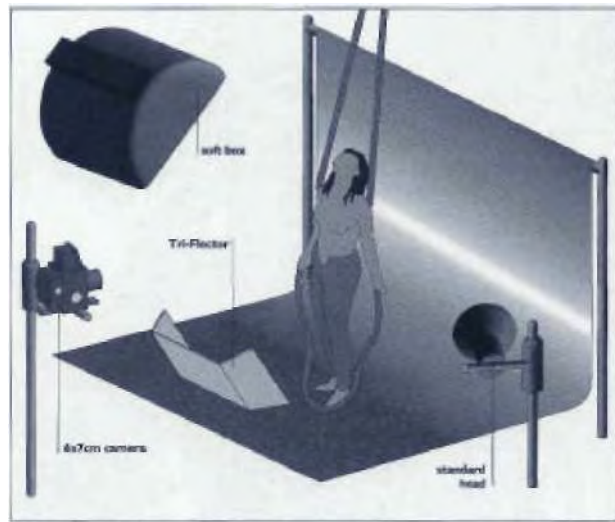

THIS PICTURE IS ALMOST ICONIC, PORTRAYING THE EMERGENCE OF THE ETERNAL FEMININE FROM A WELTER OF SYMBOLS SUCH AS ROPES, JEANS, CHAINS (AROUND HER NECK), THE CROSS AND THE FINGERLESS GLOVES.

There are only two lights, and one of those is no more than a background light; but the key, a soft box almost directly over the camera, is supplemented by a "Tri-Flector",

Invented by the photographer, the Tri-Flector (see page 24) is made in a number of different reflectivities to allow

a range of lighting effects from hard to soft. The enterprising photographer may be able to improvise an imitation for himself, from cardboard and gaffer tape, but the purpose-made item is more durable and much easier to use. Because it is (or can be) so directional and so controllable, it functions almost as another light.

- *Lighting creates chiaroscuro and modelling, while photographic technique (and the use of the 6x7 format) captures texture and detail*
- *By all but concealing the model's face, the photographer has portrayed Woman instead of a woman*
- *The sky-gazing pose is open to many interpretations by the viewer*

### Photographer's comment:

I suppose one background is much the same as another, but I prefer Lastolite. They are hand-painted in India and they have a certain vibrancy which I find lacking in some others.

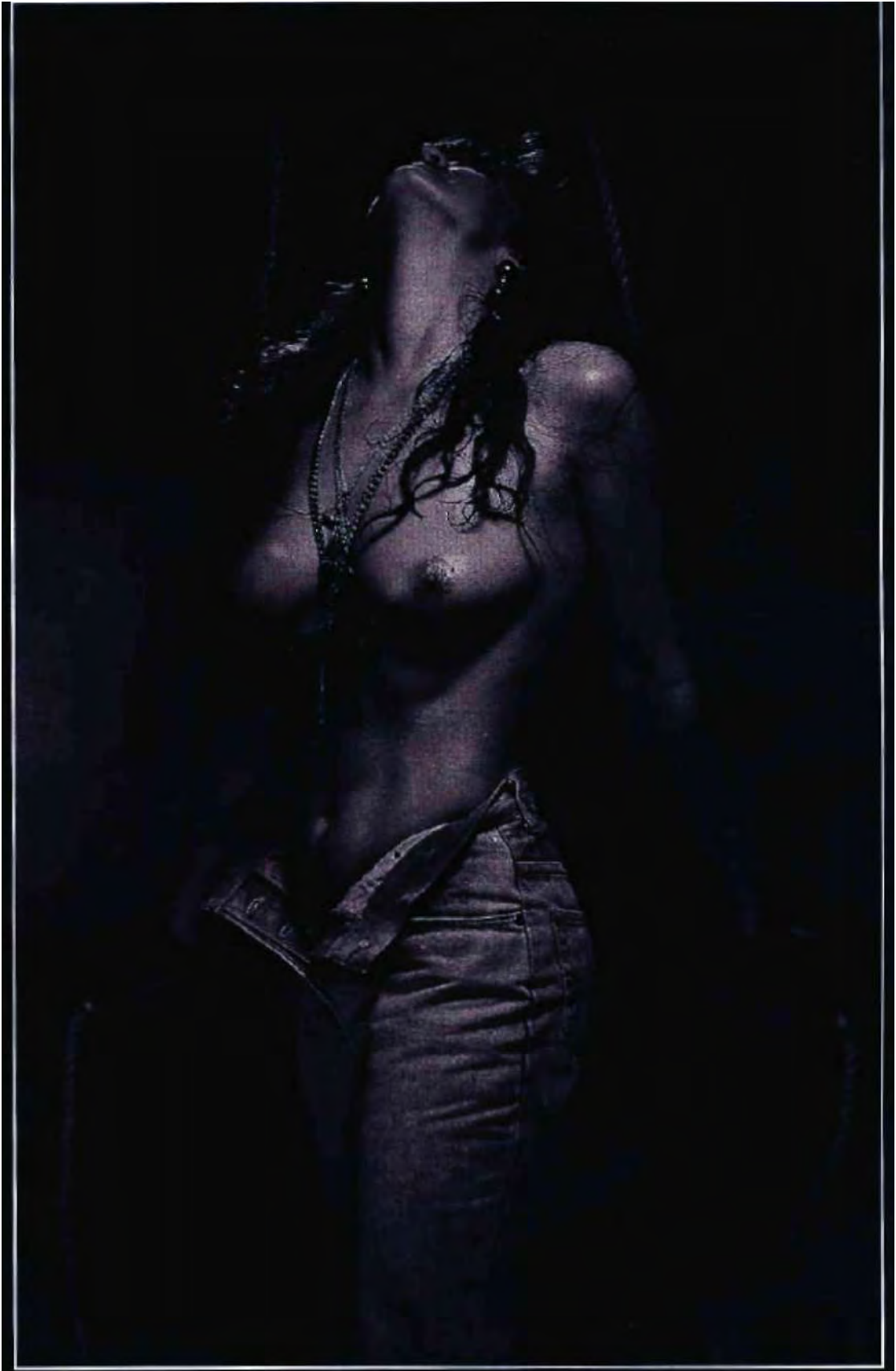

Photographer: **Peter Barry**

Use: **Model test**

Assistant: **Jon Sturdy**

Camera: **6x6cm**

Lens: **110 mm with soft screen**

Film: **Kodak Ektachrome EPR**

Exposure: **f/8**

Lighting: **Electronic flash: one very large soft box**

Props and set: **White background; white fabric as "dress"**

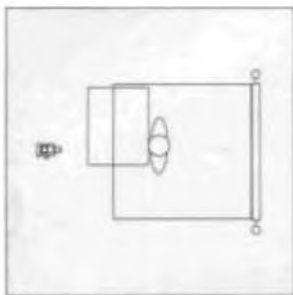

Plan View

## J U M P I N G N U D E

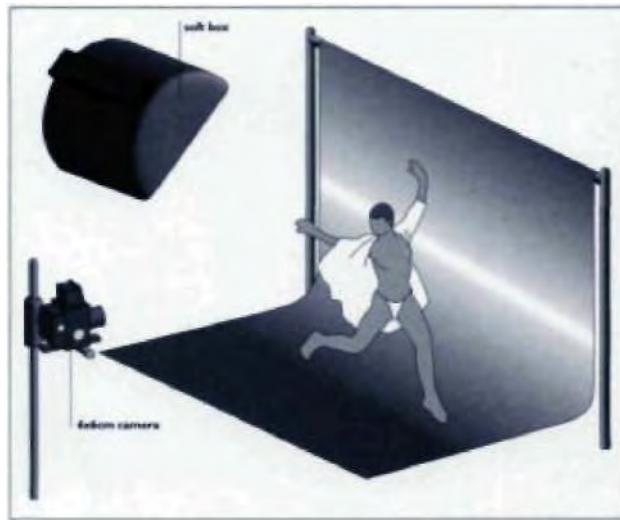

JUMPING MODELS CAN BE VERY ATTRACTIVE IF THEY ARE WELL DONE - AS, OF COURSE, PETER BARRY'S SHOT IS. YOU NEED PLENTY OF ROOM, THOUGH: A WIDE BACKGROUND, AND A LONG LENS, SO YOU NEED A FAIR-SIZED STUDIO.

The light is a very large "Wafer" soft box directly above the camera and very slightly to the left, so the shadows are very soft but the modelling is surprisingly good. Because the source is so big, it also lights the background with minimal shadowing.

Shooting this sort of motion - or any sort of action, for that matter - with a

rollfilm SLR requires a certain amount of experience, as the delay between pressing the shutter release and taking the picture can be as much as 1/10 sec. At least with flash lighting you can see whether the model was in more or less the right position as the flash goes off: with continuous light, early attempts at action can be very hit-or-miss.

- *Very large soft boxes create a different quality of light from smaller ones*
- *Anticipation and experience are important when shooting movement*

### Photographer's comment:

The Quad unit I used has quite a long flash time - about 1/700sec - so there is a tiny bit of blur which I find to be very attractive.



Photographer: **Struan**  
 Use: **Personal work**  
 Model: **Sylvia**  
 Camera: **35mm**  
 Lens: **105mm**  
 Film: **Kodak Ektachrome EPN ISO 100**  
 Exposure: **f/8**  
 Lighting: **Electronic flash: 2 heads**  
 Props and set: **Painted background;**  
**gloves; jewellery**

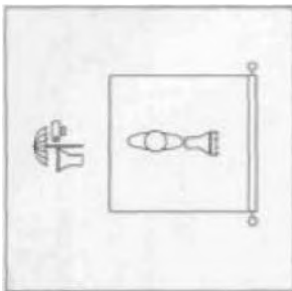

Plan View

## S Y L V I A

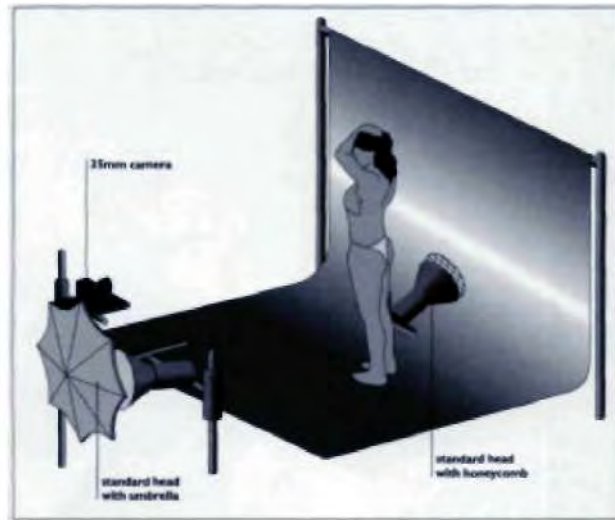

LIGHTING FROM BELOW IS OFTEN KNOWN AS "HORROR FILM" LIGHTING, AND BEGINNERS' BOOKS ON PORTRAITURE CAUTION AGAINST IT IN THE STRONGEST TERMS; BUT IF IT IS A BIG, SOFT LIGHT, IT CAN WORK.

- . *Point sources are often recommended to give jewels "fire", but large sources can sometimes work better*
- . *Exoticism (the gloves and the jewels) can "punch up" even quite modest nudity*
- . *Direct eye contact is literally eye-catching*

In this case it is an umbrella just below the camera, and it works very well indeed: look at the contrast between the model's face and the upper part of her arm, or at the small of her back. The modelling is quite unlike what you would expect from fairly diffuse frontal lighting, but this is precisely because the light is

below the camera. The lighting plot is completed by another light on the background, with a modest honeycomb (maybe 30°) to limit the spread and grade the light across the background from bottom to top. Note the contrast between the small of Sylvia's back and the background.



Photographer: **Struan**  
 Client: **Adagio**  
 Use: **Lingerie advertising**  
 Model: **Brenda**  
 Assistant: **James Fraser**  
 Camera: **35mm**  
 Lens: **50mm**  
 Film: **Kodak Tri-X Pan**  
 Exposure: **1/60sec at (f/1.4)**  
 Lighting: **Electronic flash: 2 heads (but see text)**  
 Props and set: **Black background**



Plan View

## ADAG IO



STRUAN HAS SHOT A GOOD DEAL OF ADVERTISING MATERIAL FOR ADAGIO, AND THIS IS FROM A EUROPEAN CAMPAIGN. EXPERIMENTAL INTERPRETATIONS, LESS LITERAL THAN STRAIGHT SHOTS, ARE OFTEN MORE READILY ACCEPTED IN EUROPE THAN IN NORTH AMERICA.

- *Differential focus with standard and wide-angle lenses requires very wide apertures*
- *Blur, whether from focus or from movement, is more acceptable to some clients than to others*
- *Strong contrasts often work best on out-of-focus images*

The lighting here was intended to be by flash, using two umbrellas: one directly above the model (look at the shadows) and one to illuminate the rose on the lingerie. But (in Struan's words) "I just kept turning the lights down and down, to allow shooting Tri-X at f/1.4, and suddenly I realized that the modelling lights were all I needed."

The model was asked to keep tossing her head to make her hair fly out - in such circumstances, one has to "shoot for the percentages", selecting the best from a large number of shots - and the image was printed conventionally. The bow was then hand-coloured to match its actual colour as closely as possible.

### Photographer's comment:

Adagio are among my favourite clients. They just send me the lingerie and trust me to shoot it which is always a great way to work



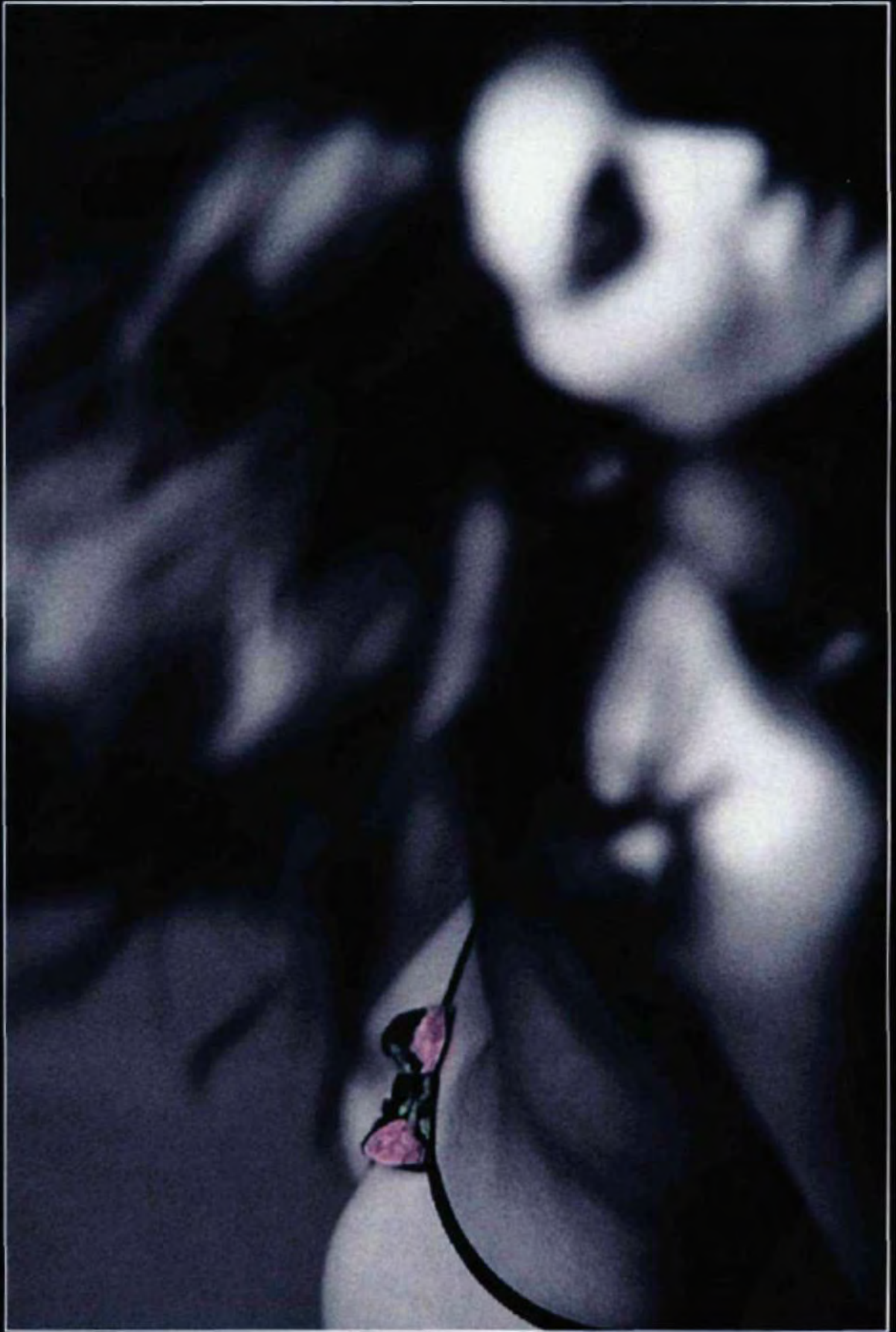

Photographer: **Struan**  
 Use: **Personal**  
 Camera: **35mm**  
 Lens: **28mm with lens shade for 35mm**

**lens**

Film: **Kodachrome 64**

Exposure: **f/16**

Lighting: **Electronic flash: 2 heads**

Props and set: **Built set**

## S M A L L R O O M

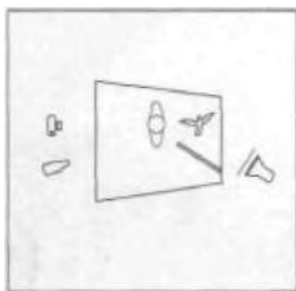

Plan View

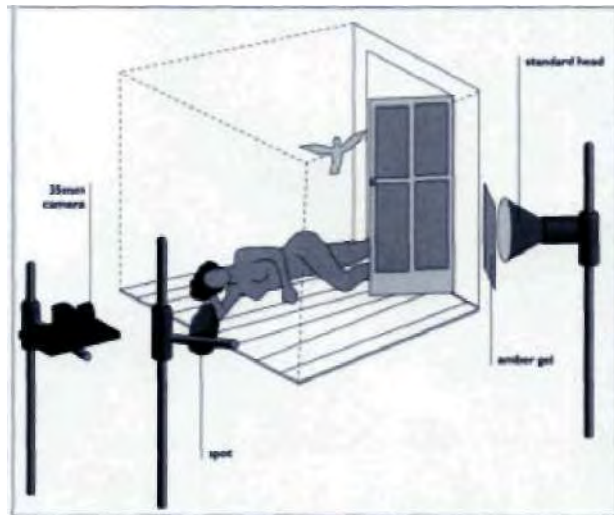

THIS IS ONE OF A NUMBER OF IDEAS WHICH STRUAN TRIED OUT WHEN HE WAS WORKING ON SURREAL AND DREAMLIKE IMAGES. THE SET IS BUILT OUT OF FOAMCORE; THE LINES ARE RIBBONS PINNED TO THE FLOOR; AND THE DARK AREAS ARE GREY BACKGROUND PAPER.

The set is, of course, built in exaggerated perspective, including the cut-out "door". Using ribbons for the lines between the "floorboards" allowed them to be moved so that they could be set to camera for the most convincing effect.

As for the lights, there is a tight (20°) grid spot on the model's face and an open-head flash outside the "door".

A 28mm lens provided the necessary exaggerated perspective. The shading in the corners comes from using the lens shade from a 35mm lens: Struan originally shaded the lens with his hand; he liked the cut-off effect, and used a shade from a lens of longer focal length to create it.

- *Building sets in exaggerated perspective is often a question of building "to camera"*
- *Birds' wings move very fast - too fast to freeze with most flash units*
- *An amber gel on the flash outside the door creates "sunlight"*

### Photographer's comment:

We once had a shoot where we needed birds. We couldn't hire them - they were ring-necked turtle doves - so we bought them. We then spent \$200 on an aviary and kept them for 15 years, until the last one died. This is one of those birds.

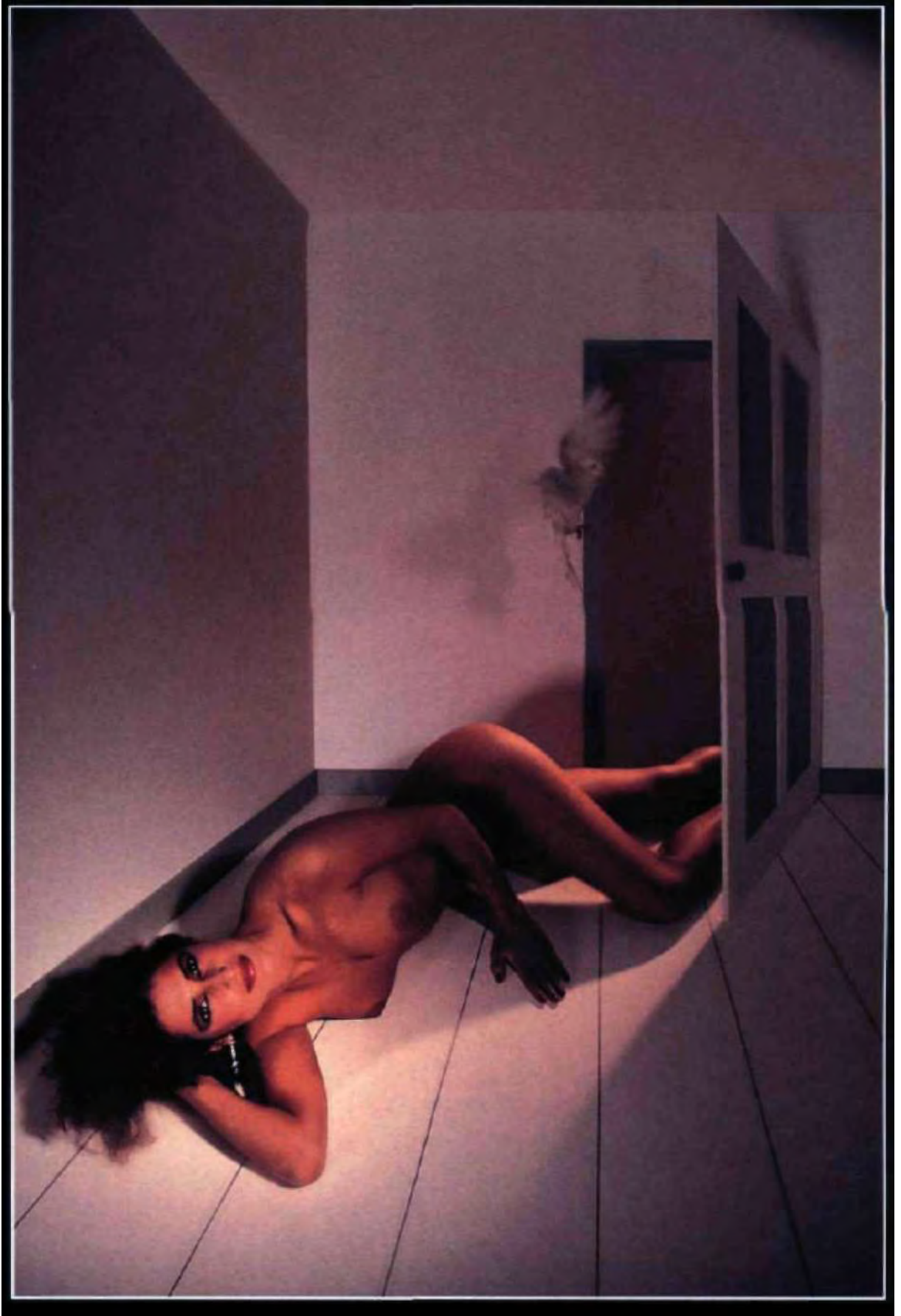



5

male nudes  
and couples



The male nude is a much less common subject than the female nude, and when we were putting the book together we were concerned that there might be a dearth of photographers who chose to submit male nudes; but we need not have worried.

An intriguing point is that all eight of the nudes and couples in this chapter were shot in monochrome, though subsequent toning was the exception rather than the rule. We did receive some male nudes in colour, and they were every bit as good as the black and whites, but they were considerably outnumbered by monochrome.

There is one calendar shot, and one advertising shot, while the others are either personal work or portfolio shots for male models. This indicates that there is still a smaller commercial demand for male nudes than for female; even so, it shows that photography of the male nude is not as rare as it might seem.

Full male nudity is however considerably rarer than full female nudity, and frontal male nudity without benefit of a strategically placed towel or something similar is very rare indeed - an interesting comment on what is "acceptable", and to whom. For all that it is a sexist cliché, it seems true that there are more men who are willing to go out of their way to look at a nude woman than there are women who can be bothered to go out of their way to look at nude men, though this is not the same as saying that women are averse to pictures of nude men.

Photographer: **Mike Dmochowski**

Use: **Self-promotion (poster)**

Models: **Dawn & Del**

Camera: **35mm**

Lens: **150mm**

Film: **Kodak T-Max 100**

Exposure: **1/125sec at f/11**

Lighting: **Electronic flash: Fresnel head**

Prop and set: **Black seamless paper background (Colorama)**

## B L U E   T O N E   O F   W O M A N A N D   M A N

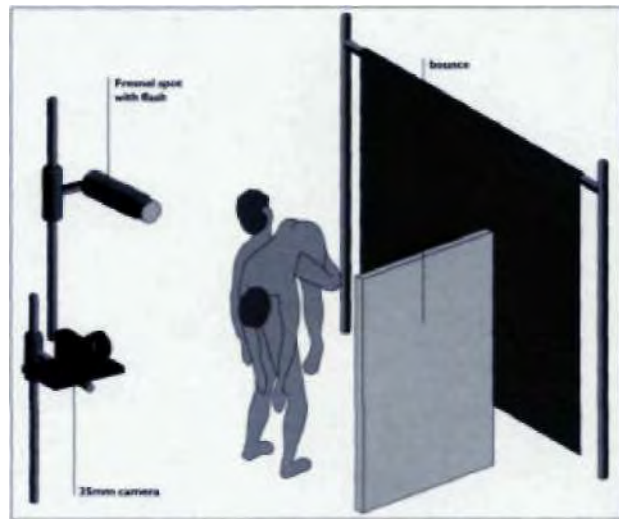

Plan View

THIS POWERFUL IMAGE IS RATHER LIKE A RORSCHACH DIAGRAM: YOU CAN READ INTO IT WHATEVER YOU LIKE. LOVE ... SUPPORT ... WAR ... LOSS - IT IS BOTH HEAVEN AND HELL. TECHNICALLY, THE ORIGINAL MONO IMAGE WAS PRINTED WITH A BLUE CASTONTO COLOUR PAPER AND THEN COPIED ONTO TRANSPARENCY.

Going via the Kodak C-type introduced the original colour while the duplication onto 4x5in Kodak Ektachrome EPP further "popped" both contrast and colour. A Fresnel head flash some 8 feet (2.4 metres) to camera left created the highly directional lighting: a Fresnel flash is harder than even the tightest honeycomb or snoot. A 240x120cm (8x4ft) bounce to camera right, about 1 m (3ft) from the

models, provided a degree of fill and stopped them from merging with the black background, which was of black paper and well behind the models -240cm (8ft) again - so that it would not be lit by spill.

The tall, thin crop further emphasizes the originality of the image: everything is taken to extremes to create a very eye-catching photograph

- *Fresnel flash heads provide about the most directional lighting that is available from general-application flash equipment*
- *The danger with highly directional light sources and black backgrounds is that the dark side of the subject can merge into the background - an effect which may or may not be desired*

### **Photographer's comment:**

The objective was to create a sensual, sculptural image.

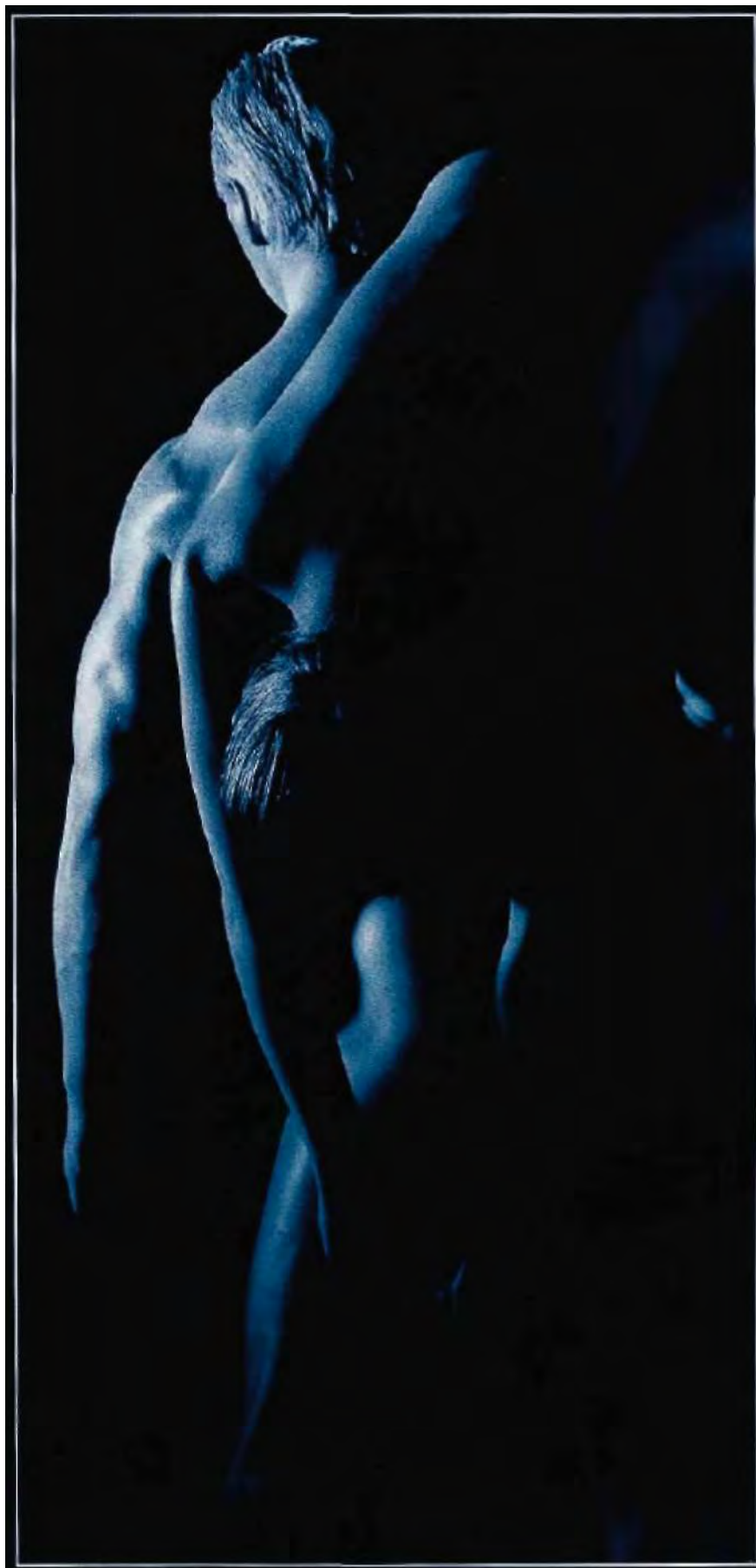

Photographer: **Nick Wright**

Client: **Directors' Cut '95**

Use: **Calendar**

Model: **Kenny**

Assistant: **Al Deane**

Art director: **Wayne Campbell**

Camera: **6x7cm**

Lens: **90mm**

Film: **Kodak T-Max 100**

Exposure: **f/16**

Lighting: **Electronic flash: single head**

Props and set: **White seamless paper**

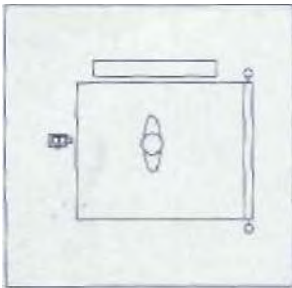

Plan View

## K E N N Y

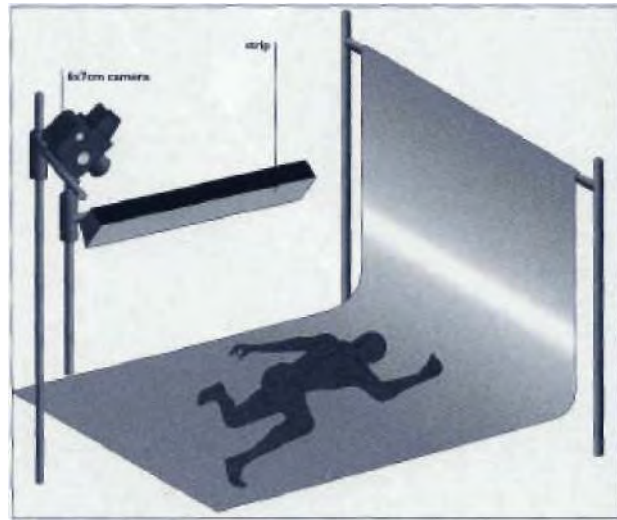

THIS TIMELESS NUDE IS LIT SURPRISINGLY SIMPLY, BUT GETTING A TOTALLY CLEAN, WHITE GROUND WAS A PROBLEM: IN THE EVENT, THE PRINT HAD TO BE MADE VERY CAREFULLY IN ORDER TO LOSE A COUPLE OF MARKS ON THE PAPER.

There is a single light, but it is a 120cm (4ft) long strip light, only about 20cm (8in) wide. Once you know this, you can work out exactly where the light is: in essence, parallel with Kenny's right arm and set at the right height to give the most dramatic shadow; note also how neatly it delineates the face. A linear light source like this gives much sharper shadows than a soft box, but without the splaying of shadows that you would get with a standard reflector. It also gives beautifully controllable highlights.

- *Strips are normally associated with large studio lights such as Strobex, but they can be approximated with appropriately-shaped soft boxes on standard heads*
- *Careful control of exposure and development is needed to control gradation in a shot like this*

### **Photographer's comment:**

I was standing on a ladder with a high tripod, but Kenny is a very big man and I needed the 90mm to get him in.





Photographer: **Stu Williamson**  
 Client: **Brendon**  
 Use: **Modelling portfolio**  
 Camera: **35mm**  
 Lens: **85mm**  
 Film: **Ilford HP5 Plus**  
 Exposure: **f/8**  
 Lighting: **Electronic flash: 4 heads**  
 Props and set: **Lastolite black background**

## BRENDON

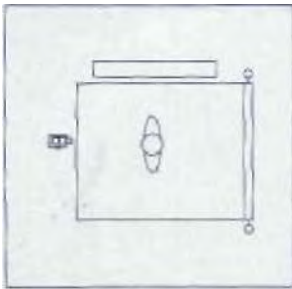

Plan View

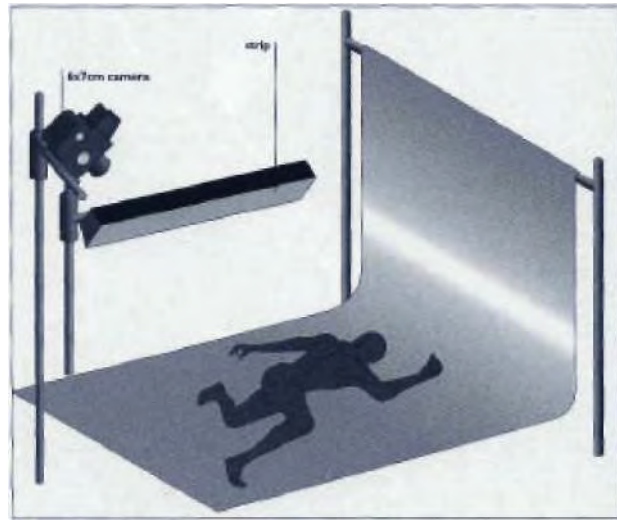

A MODERN MALE MODEL MAY BE CALLED UPON TO PORTRAY, ALL KINDS OF ROLES, FROM VULNERABLE TO TOUGH, FROM FASHION ICON TO FASHION VICTIM. THIS IS A REMARKABLY

- *Body shape and facial expression often require very different types of lighting*
- *Mimicking naturalness with complex lighting is often more effective than genuinely natural lighting, which can be unidirectional*

The lighting is surprisingly complex. A strip light to camera right delineates the model's back and buttocks, while a soft box to camera left provides the modelling on his front; notice the change of emphasis in the shadows between the upper part of his body, so that both the strength of his legs and the breadth of his

shoulders are emphasized. Then, a spot lights his face only, for personality and eye contact. Finally, a small snooted spot on the background creates the highlight to camera left, in front of the model. Cover that up, and suddenly the picture is clinical, or perhaps voyeuristic, instead of a nude portrait.

### Photographer's comment:

I normally use 6x7cm but In 35mm I love my Contax, especially with the 85mm f/1.4 lens.



Photographer: **Stu Williamson**  
 Client: **Simon**  
 Use: **Model portfolio**  
 Camera: **6x7cm**  
 Lens: **140mm**  
 Film: **Ilford HP5 Plus**  
 Exposure: **f/11**  
 Lighting: **Electronic flash: 3 heads**  
 Props and set: **Lastolite black background, pickaxe handle**

## B O D Y W O R K

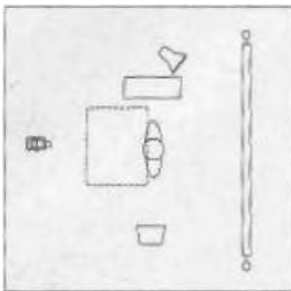

Plan View

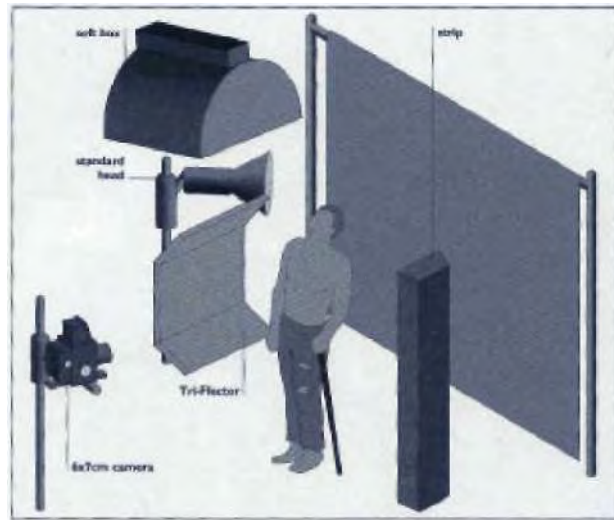

THERE ARE ECHOES HERE OF SOCIALIST REALISM - THE OLD STALINIST PICTURES OF HEROIC STAKHANOVITES TOILING FOR THE MOTHERLAND. THE POSE, THE PROPS AND THE LIGHTING ALL CONTRIBUTE TO THIS.

- *Direct overhead lighting is not normally recommended for photographing people but it can be made to work*
- *Strip lights can be useful for delineation*
- *Not everyone can look convincing in ripped jeans, partially undone; Simon can*

The jutting jaw is emphasized by the key light, which is a soft box almost directly over the model's head. The brightly lit face has quasi-religious overtones: seeing the light, a brighter tomorrow. The glancing light also emphasizes the texture of the torn jeans and the contours of the muscles and the veins. A left arm

and provides a (very) modest amount of fill, while a "Tri-Flector" (see page 24) to camera-left evens out the lighting somewhat on the model's right side. The background is separately lit with a standard head. Using HP5 Plus, a fast "old-technology" film (as distinct from the "new-technology" Delta series), gives a surprisingly long tonal range.

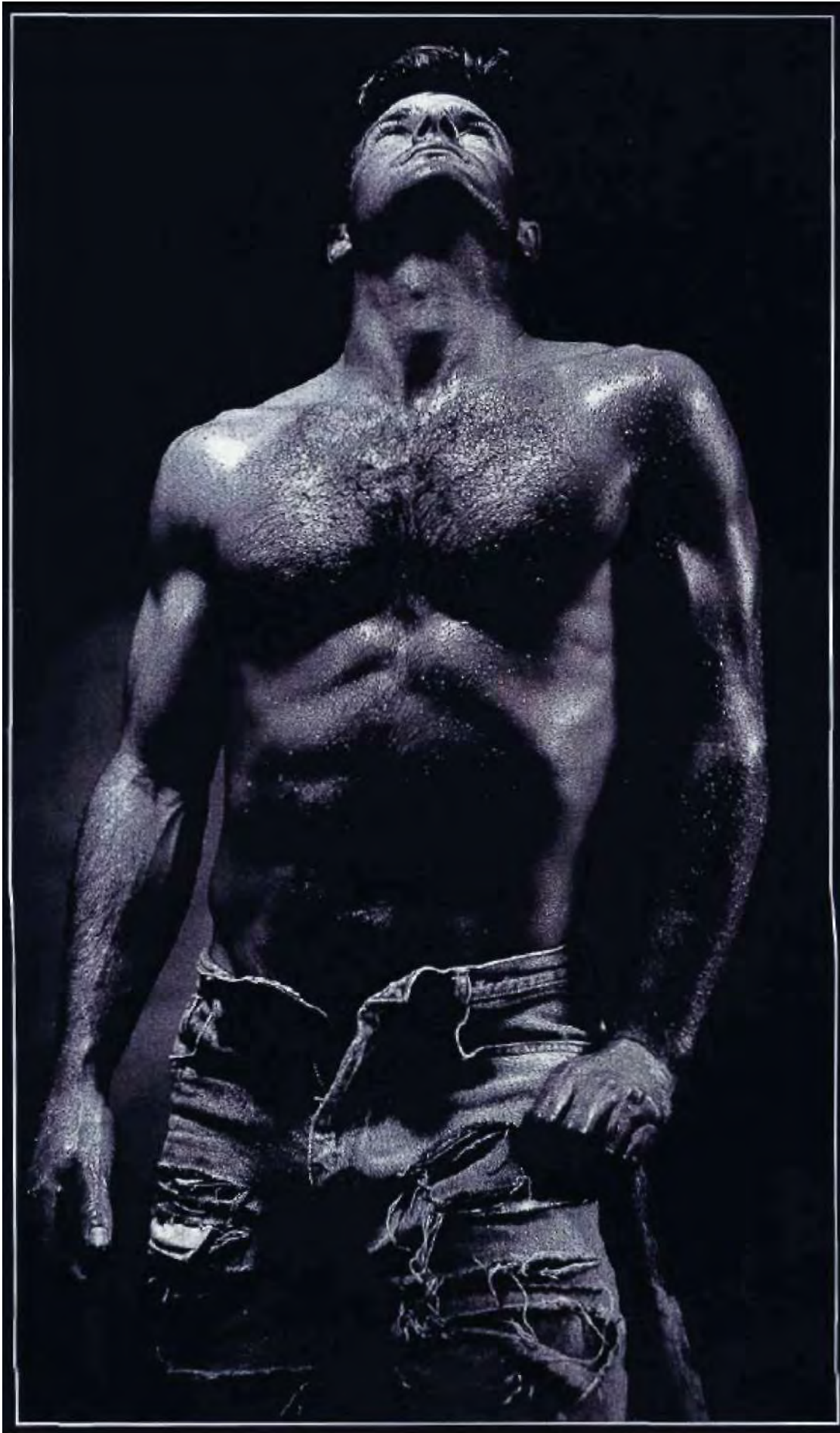

Photographer: **Stu Williamson**  
 Clients: **Simon & Correna**  
 Use: **Modelling portfolio**  
 Camera: **6x7cm**  
 Lens: **105mm**  
 Film: **Kodak Plus-X Pan**  
 Exposure: **f/11**  
 Lighting: **Electronic flash: 2 heads**  
 Props and set: **Rope; muslin; Lastolite**  
**hand-painted background**

**S I M O N   A N D   C O R R E N A**

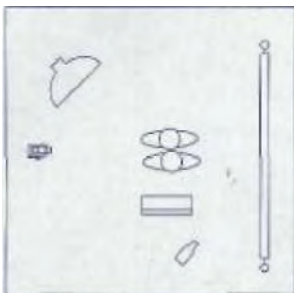

Plan View

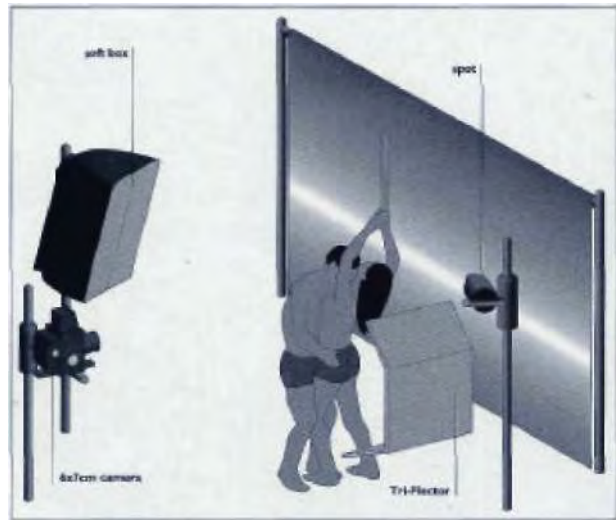

AS WITH MANY OF STU WILLIAMSON'S PICTURES, THE RESONANCES HERE ARE OUTSIDE PHOTOGRAPHY: THE SHAPE OF SLMON'S BACK IS REMINISCENT OF NLJINSKY IN L'APRES-MIDI D'UNE FAUNE, WHILE THE OVERALL POSE BRINGS TO MIND CALIBAN AND THE TEMPEST.

The lighting is remarkably simple. A large soft box to camera left is the key, and indeed the only light on the subject. It is however supplemented by a "Tri-Flector" to camera right, low behind Correna; look at the light on the cloth around her hips. A second light, a standard head, illuminates the Lastolite painted background. The film - Kodak Plus-X Pan - was carefully chosen and developed to give the appropriate tonality. After that a good deal of the impact depended on the printing: Stu prints all his own pictures, as this is an integral part of his vision.

- *With a transparency the image is effectively finished when it is printed; with a print, as Ansel Adams said, "the negative is the score and the print is the performance"*
- *Exercises with two lights - one on the subject, one on the background — should be an essential part of every photographer's education*

**Photographer's comment:**

The loin-cloths are just muslin; I have various ways of dyeing and ageing cloth - in effect, of getting it "dirty" under controlled conditions.



Photographer: **Julia Martinez**

Client: **Christiaan**

Use: **Model portfolio**

Camera: **35mm**

Lens: **50mm**

Film: **Kodak T-Max ISO 100**

Exposure: **f/11**

Lighting: **Available light plus on-camera flash**

Props and set: **Location: very small shower**

## C H R I S T I A A N I N T H E S H O W E R

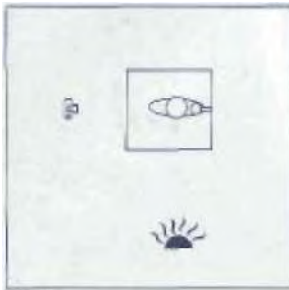

Plan View

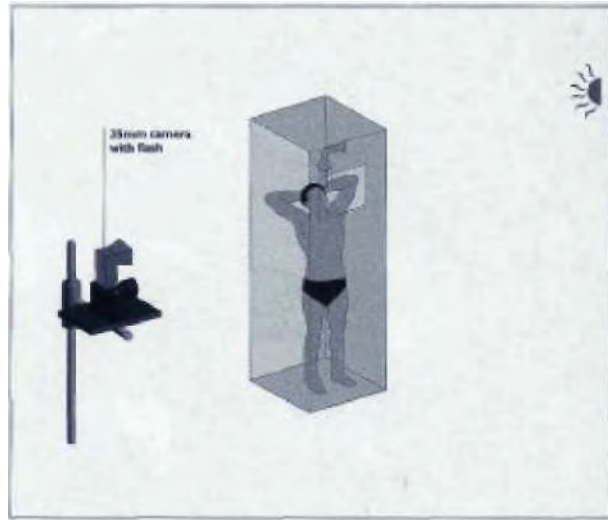

IT IS A COMMON JOKE AMONG PHOTOGRAPHERS THAT THE ONLY TIME THAT AN ON-CAMERA FLASH DELIVERS ITS FULL RATED GUIDE NUMBER IS IN A VERY SMALL WHITE-PAINTED BATHROOM - WHICH IS WHERE JULIA SHOT THIS PICTURE. IN HER WORDS:

- *On-camera flash can be a medium worth experimenting with*
- *Plenty of reflectors can even out the hardest light*
- *Electronic flash and water can be a dangerous combination*

"I say it's an available light shot, but really behind him. There was a small window, the flash is doing all the work. It's one of rather above the model to camera right, those tiny Spanish showers, with white- which explains why the shadow above his painted concrete walls. It was difficult to head is paler than the shadow beside him. keep the camera dry, because I was getting The white walls of the shower evened out the light considerably. The print was made splashed, but it was good to work with the on Kentmere Art Classic and selenium- the bare minimum of equipment." You can see toned. the highlights on Christiaan's chest, and the shadows on the wall

### **Photographer's comment:**

Christiaan is my best friend and wanted some pictures for his modelling portfolio.



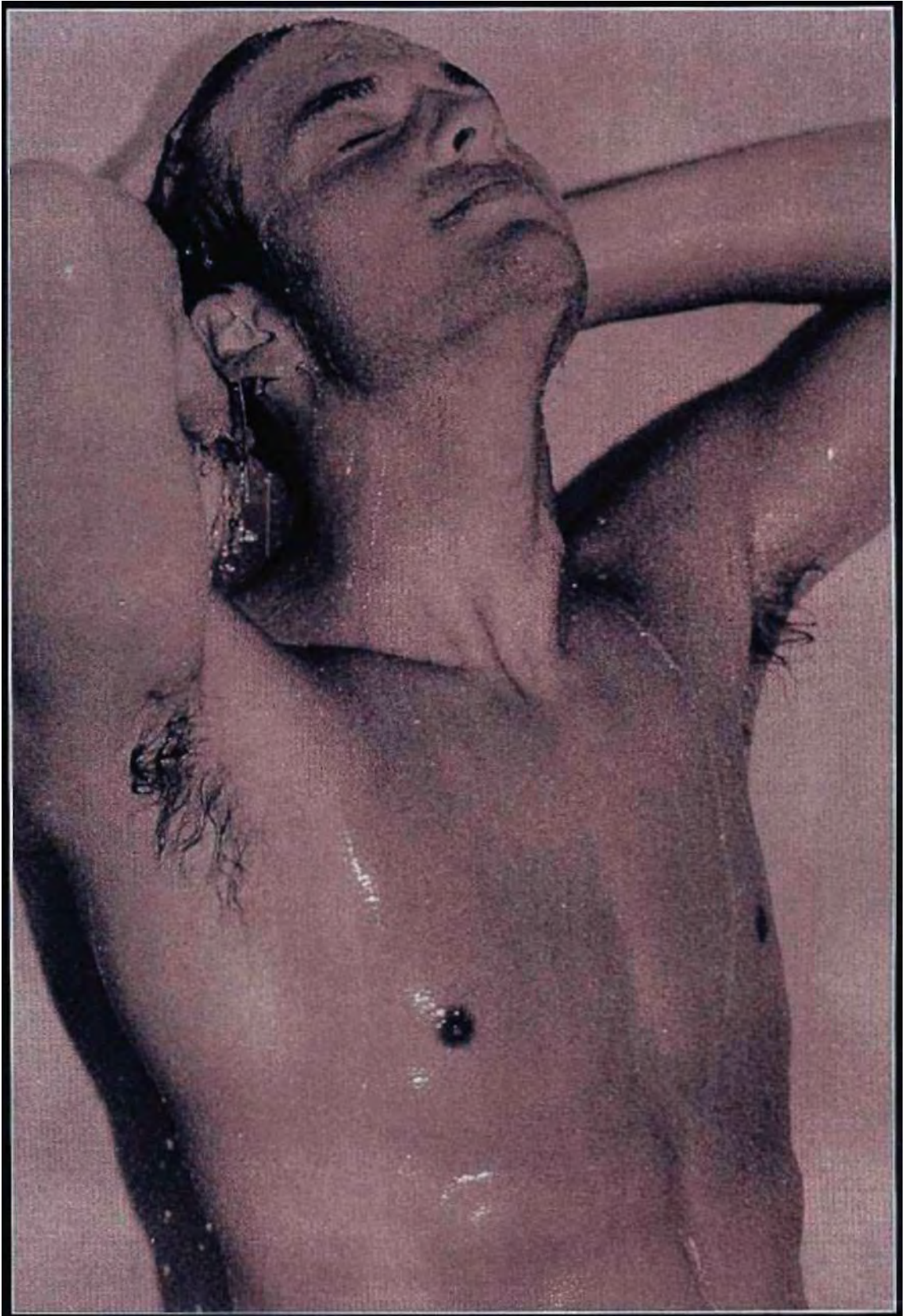

Photographer: **Struan**  
 Client: **Karl Lagerfeld**  
 Use: **Advertising ("Photo" cologne for men)**  
 Model: **Rob Simpson**  
 Camera: **35mm**  
 Lens: **105mm**  
 Film: **Kodak Tri-X Pan**  
 Exposure: **f/11**  
 Lighting: **Electronic flash: 1 head**  
 Props and set: **Black wall sprayed with moisture**

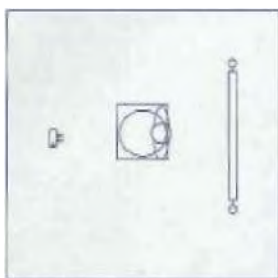

Plan View

## PHO TO

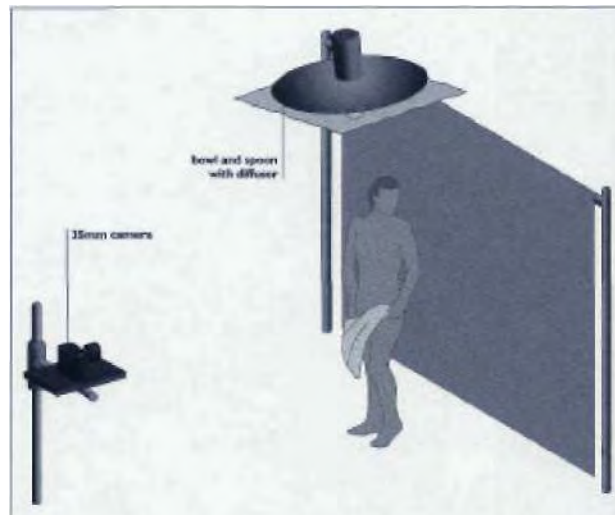

A NEW MEN'S COLOGNE CALLED "PHOTO"... BLACK AND WHITE PHOTOGRAPHY ...  
 A DYNAMIC ACTOR/MALE MODEL LOOK - THE LOGIC IS CLEAR ENOUGH. BUT IT  
 TAKES A GOOD PHOTOGRAPHER TO CONVERT THE LOGIC INTO A PICTURE.

The lighting is surprisingly simple: a 500mm (20in) reflector on a standard head, mounted on a boom arm directly above the model and diffused with a sheet of tracing paper.

Overhead lighting may be of limited use out of doors, but it can be very effective in the studio. It can be particularly useful when the background

is an integral part of the picture, as it is here: without the moisture on the wall (which was painted with black latex paint), the background is too bleak. The white towel completes the slightly diagonal composition of the picture; without it, the tones would simply peter out towards the bottom.

- *Use things like towels, books, flowers and so forth as areas of tone to complete a composition*
- *Light items like the towel must not be too near the light source or they may burn out*
- *White fabric is between five and ten times as reflective as skin*

### Photographer's comment:

For the launch of Lagerfeld's new cologne/after-shave I arranged for six female photographers and two male (including myself) to provide our own interpretations of the product.

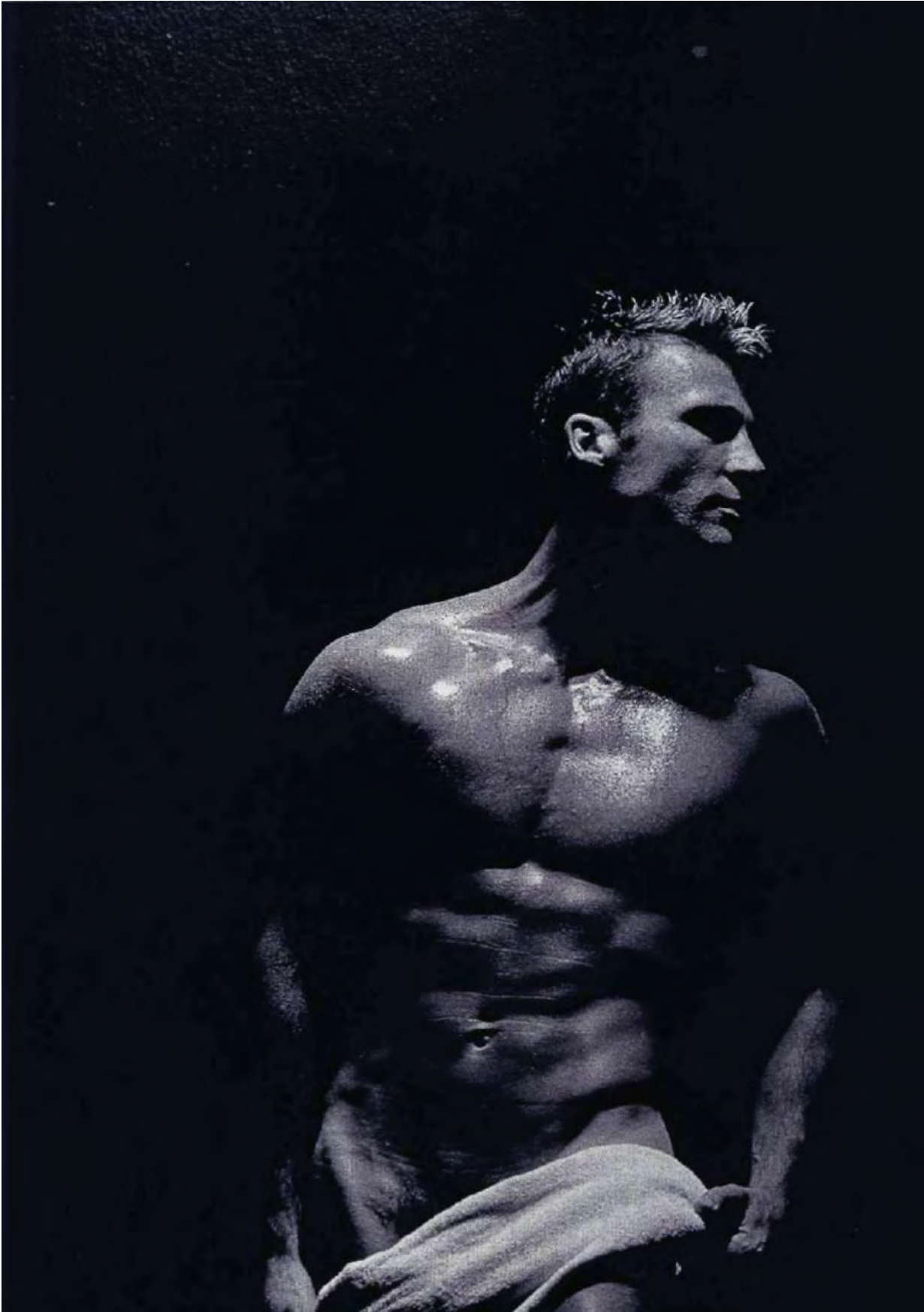



6

the  
outdoor  
nude



When you think about it, the rigid prohibitions on public nudity which exist in so many societies are pretty illogical. Those who go beyond an automatic prohibition will often advance the aesthetic argument, "Most people do not look very attractive without any clothes on", which completely ignores the fact that an awful lot of people do not look very good with clothes on, either.

There are two strands to the aesthetic of the outdoor nude, one of which owes more to natural nudity, and the other of which owes more to fantasy. Natural nudity reflects something that most people must feel like doing sometimes: feeling the wind and the sun on their skin, untrammelled by local conventions of what may be revealed and what may not. Inevitably, there are degrees of naturalness, with something like Struan's Blue Pool or Frank Wartenberg's *Nude with Car* looking as if the photographer just happened to take a picture of a girl who just happened to have taken her clothes off, while Harry Lomax's *Outdoor Nude* or Bob Shell's *Heidi in the Palmetto* are more self-consciously posed.

The fantasy nude is perhaps typified by Mike Dmochowski's *Nude on Chair with Table*, where a beautiful girl waits at a cafe table. Many men might wish that they were away from their desks on a rainy day, and sipping a cappuccino or a kir on a shady sidewalk by a sunny street. The girl simply expands the fantasy. Struan's *Window and Shutters* is another enduring fantasy: the beautiful nude glimpsed at a window.

Photographer: **Mike Dmochowski**

Use: **Glamour video**

Model: **Nella**

Camera: **6x6cm**

Lens: **150mm + warming filter**

Film: **Kodak Ektachrome EPP 120**

Exposure: **1/125sec at f/11**

Lighting: **Electronic flash: 3 heads**

Props and set: **Built set**

## M O D E L O N C H A I R W I T H T A B L E



Plan View

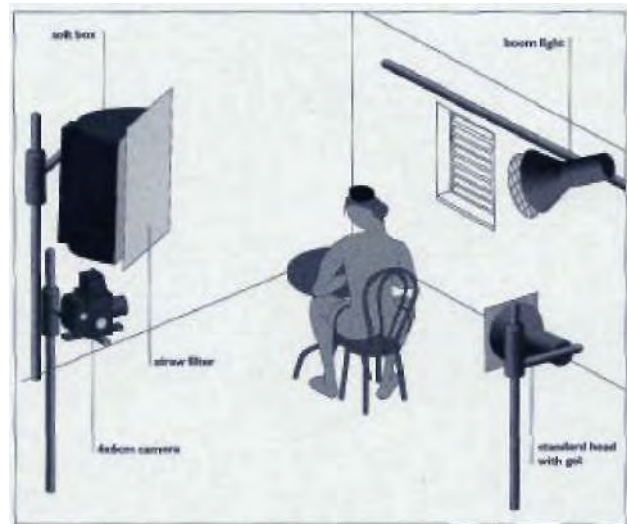

BUILT SETS ARE ONE OF THE SECRETS OF MANY SUCCESSFUL GLAMOUR PHOTOGRAPHERS - THEY ALLOW FULL CONTROL OF THE AMBIENCE AND LIGHTING, WITHOUT FEAR OF ONLOOKERS - BUT LIGHTING IS ANOTHER. THIS FORMS PART OF A LARGE NUMBER OF PICTURES SHOT FOR A VIDEO CAPTURED SECRETS, WHICH MIKE PRODUCED.

A direct side light with a wide honeycomb, set to camera right and slightly back lighting the model, creates the impression of sunlight coming in under an awning or onto a balcony. This light is some 120cm (4ft) from the model and 150cm (5ft) above the floor.

A small, square soft light with a straw filter provides the highlights on the left; this creates the impression of sunlight bouncing off ancient stucco. Again this is about 120cm (4ft) from the model, and about 150cm (5ft) from the floor.

The exposure reading from this alone, pointing the meter at the light from the subject position, was f/11.

Finally, a boom light some 240cm (8ft) above the ground provides a back light. Like the fill, the reading from this alone was f/8.

- *The illusion of sunlight is often harder to create than might be expected. Plenty of power will make it easier*
- *A good set will create its own expectations as far as lighting goes, and the eye will "read" whatever seems most appropriate*
- *Incident-light metering with a flat receptor (not a dome) makes it easier to determine lighting ratios*

### **Photographer's comment:**

*This video is still available; my address is at the back of the book, in the Directory section.*



Photographer: **Harry Lomax**  
 Use: **Library**  
 Model: **Claire**  
 Camera: **6x6cm**  
 Lens: **150mm**  
 Film: **Fuji RDP ISO 100**  
 Exposure: **1/30sec at f/11**  
 Lighting: **Daylight plus flash**  
 Props and set : **Location**

## O U T D O O R N U D E



Plan View

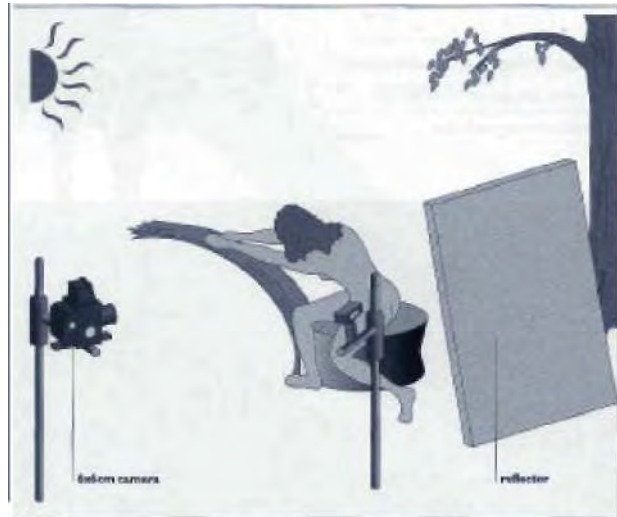

THE SURPRISE IN THIS ATTRACTIVE AND NATURAL-LOOKING PICTURE IS HOW MUCH DIFFERENCE CAN BE MADE BY A RELATIVELY WEAK FLASH AND A REFLECTOR AT QUITE A CONSIDERABLE DISTANCE - 4.5M (15FT) - FROM THE SUBJECT.

The key light is arguably sunlight from camera left, but it is supplemented by a Metz 45 CT flash bounced off a reflector (size not recorded) mounted about 2m (6'6ft) off the ground to camera right. The reason for the flash was almost the opposite of a fill: the aim was to throw the inner curves of the model's body more fully into the shadow. The two sources are almost exactly equal in value.

A great deal of control is however afforded by the way in which flash is affected only by aperture, but ambient light is affected by both aperture and exposure time. Thus, if this same picture had been shot at 1/60sec instead of 1/30, the flash would have been dominant, but if it had been shot at 1/15 the daylight would have been dominant.

- *Aperture alone controls flash exposure, but aperture and exposure duration control ambient-light exposure*
- *Using flash reduces the problem of dappled sunlight and also reduces the greenish cast which is sometimes introduced by foliage*
- *A very weak magenta filter (cc05m) can counter a greenish cast without looking too obvious*





Photographer: **Frank P. Wartenberg**

Use: **Portfolio**

Camera: **35mm**

Lens: **105mm with orange filter**

Film: **Polaroid Polagraph**

Exposure: **Not recorded**

Lighting: **Early morning sunlight**

Props and set: **Car**

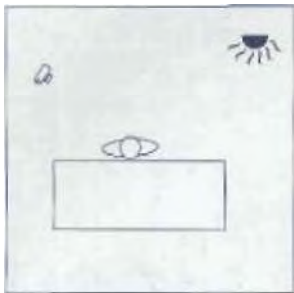

Plan View

## N U D E   W I T H   C A R



THE MODEL IS LEANING ON A CAR, WITH THE EARLY MORNING SUN BEHIND HER; SHE IS BACKLIT, WITH NO REFLECTOR TO ACT AS A BOUNCE. AS IS CLEAR FROM THE DIRECTION OF THE SHADOWS, THE SUN HAS JUST RISEN.

Very early morning sun has a wonderful quality, but the effect is short-lived -there are no more than a few minutes of that almost liquid red light - and the lighting changes very rapidly doubling and doubling again as the sun rises; this makes metering difficult, and practically demands

extensive bracketing. Also the initial light levels are surprisingly low, and long exposures may be called for. It is often as well to have several bodies loaded (or several backs, in the case of roll film) to obviate the need for reloading.

- *It may be as well to load several bodies with different films, to compare the different effects*
- *Alternatively, exhaustive exploration of a particular film stock may prove more rewarding*
- *You may need to use extensive bracketing, or have an assistant taking continuous readings, or (if you trust it) you can use automatic exposure*

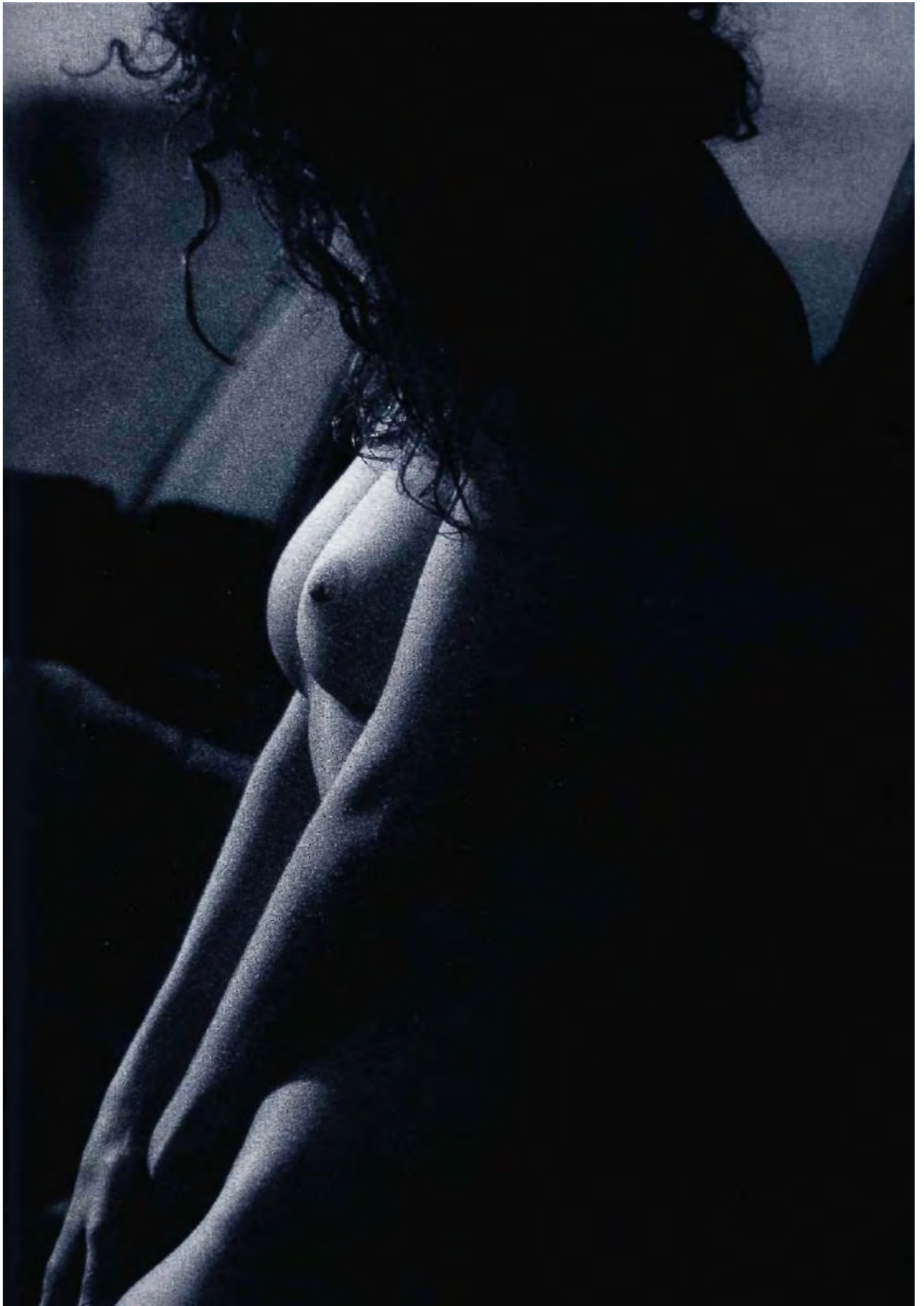

Photographer: **Struan**  
 Use: **Personal work**  
 Model: **Coralie**  
 Camera: **35mm**  
 Lens: **35mm**  
 Film: **Kodak Tri-X Pan rated at EI 200**  
 Exposure: **1/60sec at f/5.6**  
 Lighting: **Available light**  
 Props and set: **Salt, sheet**

## S A L T     D U N E S



Plan View

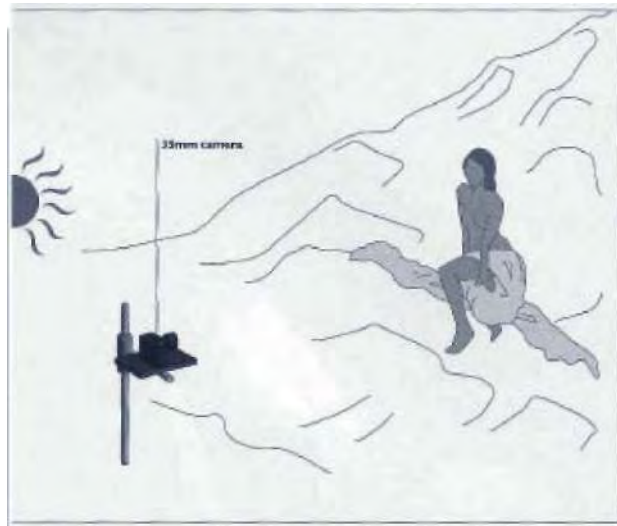

CONTRARY TO APPEARANCE THESE HUGE DUNES ARE NOT OF SAND BUT OF SALT. STRUAN HAD BEEN SHOOTING A BLACK DRESS FOR A CLIENT EARLIER THAT DAY; THIS WAS PERSONAL WORK, SHOT BY THE DYING LIGHT.

- *In the last quarter hour or so before the sun sets, the light changes very rapidly indeed*
- *The very red quality of the setting sun often seems to create an unusual effect in monochrome*

As he puts it, "When the paid shoot was finished, and everyone else was going home, I asked the model if she minded staying behind for some more portfolio shots. The sun was very low, and the evening was beginning to get hazy: a few minutes later, it was too dark to shoot. It was really nice light, though. Earlier, it had

been rather harsh and contrasty, but this was really good".

The salt acts as a giant reflector, bouncing light everywhere and creating a very even light in these conditions, and one of Struan's trusty all-purpose sheets (see pages 69) was pressed into service as well.

### Photographer's comment:

*If you just pack up and go home when the commercial shoot is finished, you can miss some really good personal shots.*

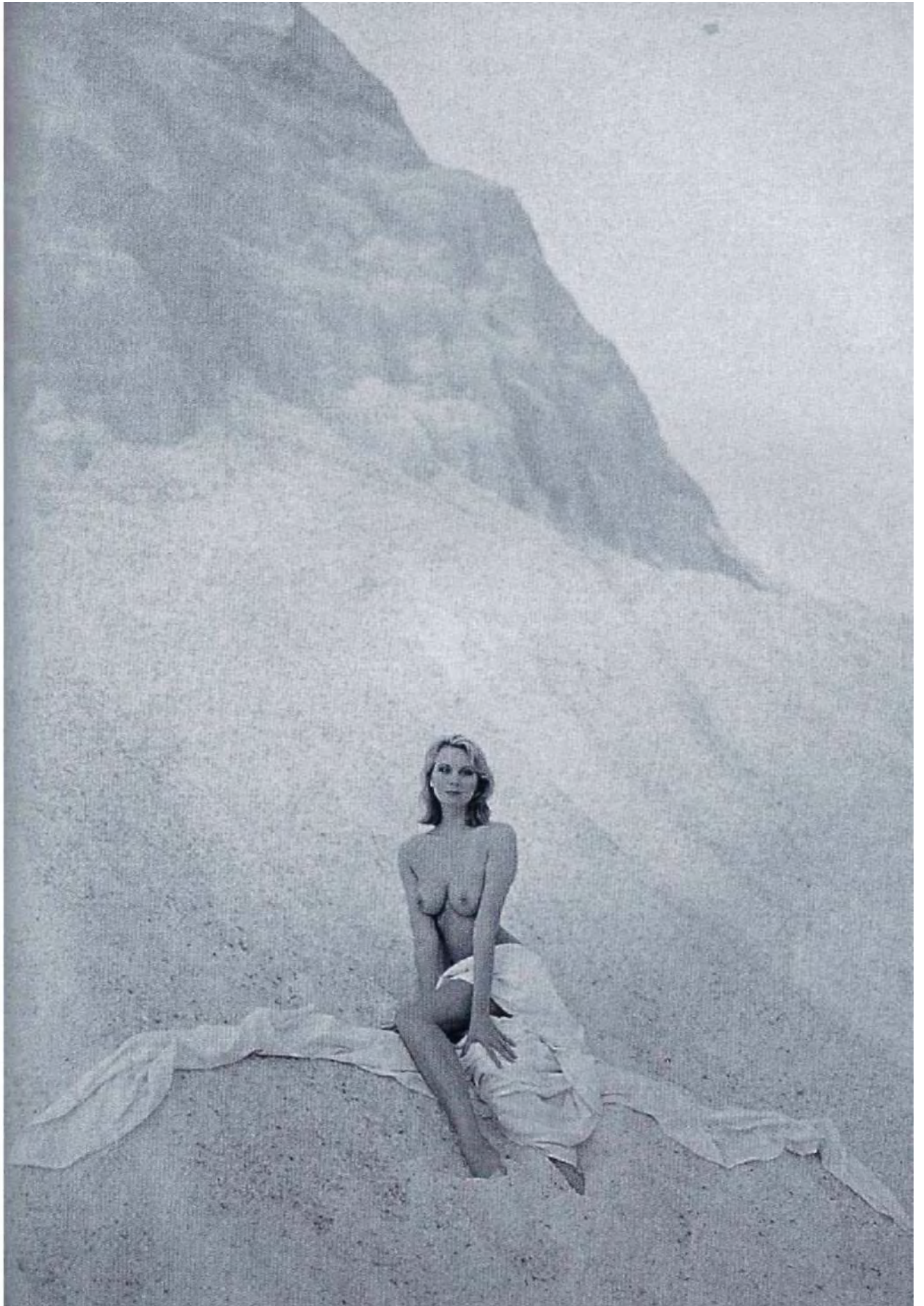

Photographer: **Struan**  
 Use: **Personal work**  
 Model: **Alex**  
 Camera: **35mm**  
 Lens: **35mm**  
 Film: **Kodak Ektachrome EPN ISO 100**  
 Exposure: **1/60sec at f/4**  
 Lighting: **Available light**  
 Props and set: **Li-Lo type bed; sheets**

## B L U E   P O O L

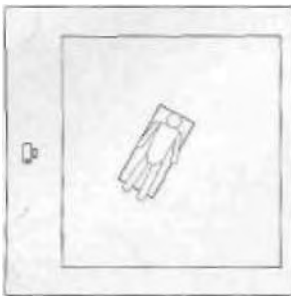

Plan View



THE MODEL WAS AN ACTRESS VISITING FROM LOS ANGELES. STRUAN BORROWED A FRIEND'S POOL AS A GOOD SETTING. ONE SHEET WAS DRAPED OVER THE FLOATING BED, AND A SECOND SHEET WAS USED AS A PARTIAL DRAPE FOR THE MODEL

The lighting was overcast daylight at about 3 to 4 pm. It was sufficiently diffuse that, in Struan's own words, "I had a reflector with me, but it wasn't doing anything".

It was therefore a matter principally of pose and of composition. This picture well illustrates that partial veiling is often more attractive than complete nudity, and the diagonal composition in a vertical

frame has a very different mood from what could have been achieved with a horizontal composition. The generous amount of blue water above the model's head includes reflections as a part of the composition. The 35mm lens makes the subject's legs look even longer, but note how the toes are pointed to avoid making her feet seem too big.

- *Whether filtration is needed on an overcast day, and how much is needed, can depend very much on the film in use*
- *When the contrast of colours is strong, as here, there may be little need for filtration*
- *Sometimes a wide angle is necessary just to get enough in: it is not always used merely to make legs look longer*

### **Photographer's comment:**

*I find my sheets extremely useful for all kinds of things, though my laundry bills are sometimes pretty high.*



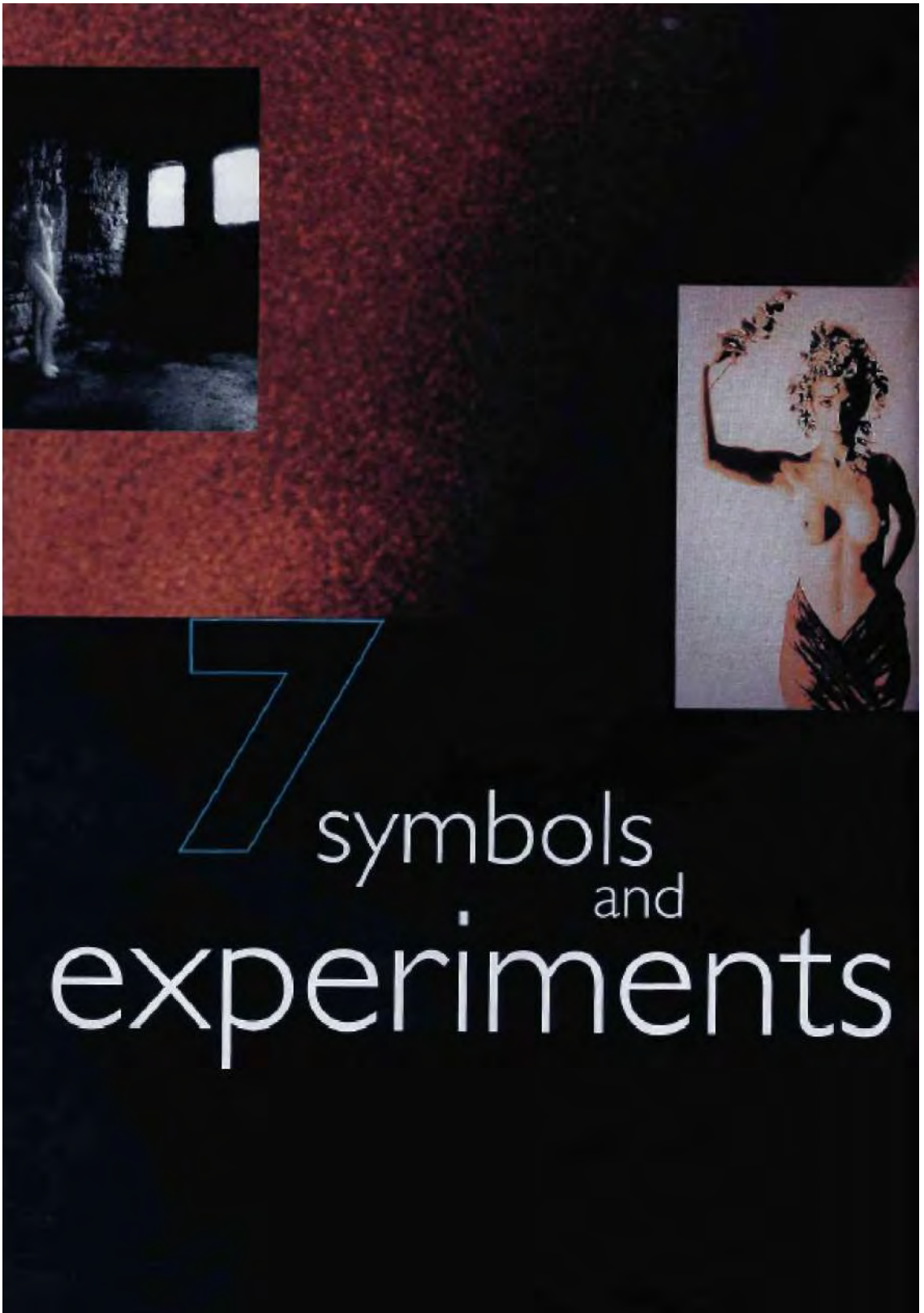

7 symbols  
and  
experiments





In most of the Pro-Lighting books to date, the seventh chapter has been made up mainly of pictures which defy classification elsewhere; and this is no exception. Some are very simple, both in concept and in execution, while others verge on the bizarre.

Perhaps the best word to describe the underlying similarities between them is that they tend to be to some extent surreal. In other words, they are not like the fantasies of Chapter 4; the twist which they impart to reality is often subtler, whether it be the architectural curve of a model above a shoe in Struan's advertisement for Charles Jordan, the uncertain presence of a ghostly model in Peter Goodrum's *Infra-Red Nude*, the abstraction of form and contour in Mike Dmochowski's *Gold Close Up*, or the impression of looking into another time in Ben Lagunas and Alex Juri's *Maniki*.

In this chapter 35mm predominates: the actual figures are four 35mm, three roll film, and (rather surprisingly) two on 4x5in. Extensive manipulation of the images - by toning, by hand colouring, or even by computer - renders it somewhat irrelevant which films were used; and the same could be said of the equipment. In fact, the message once again is that, always and above all, it is the photographer's eye that makes the picture. We hope that as you embark on this, the last chapter, you have been fired with new ideas and that you will find this book as much a source of inspiration as of information.

Photographer: **Ben Lagunas & Alex**

**Kuri**

Client: **Private Art**

Use: **Gallery**

Assistant: **Isak de Ita**

Art director: **Ben Lagunas**

Stylist: **Alex Kuri**

Camera: **35mm**

Lens: **180mm**

Film: **Kodak LPP**

Exposure: **f/22**

Lighting: **Electronic flash: 4 heads**

Props and set: **White backdrop; flowers**

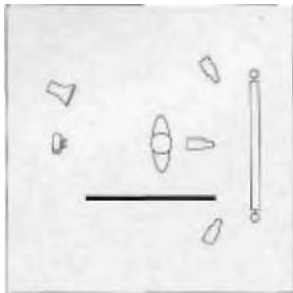

Plan View

## CARATTI FLOWERS

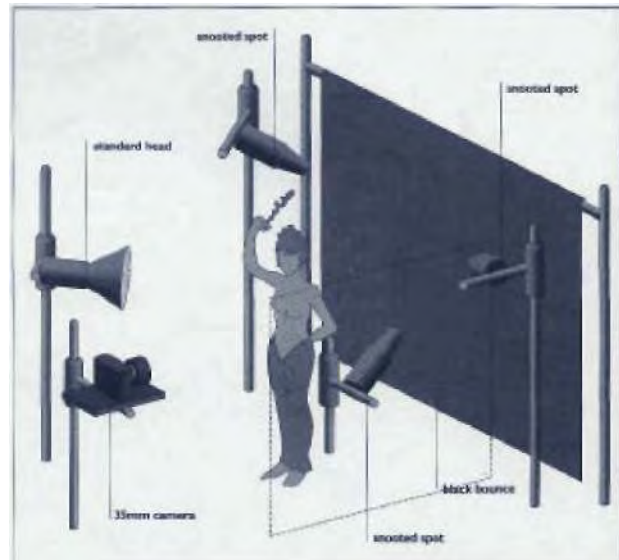

TONING AND DYEING CAN CONSIDERABLY INFLUENCE THE IMPACT OF A PICTURE – AND OFTEN, A TONED OR DYED IMAGE (BOTH TECHNIQUES WERE USED HERE) WILL CALL FOR CONSIDERABLY MORE DRAMATIC LIGHTING THAN WOULD BE USUAL IN A MORE CONVENTIONAL PHOTOGRAPH.

The lighting is actually quite simple. Three snooted spots illuminate the background brilliantly - lens flare from the brightness of the background reduces the model's raised arm to a sculptural mass - while the key light is a standard head to camera

left. The extremely directional nature of the key light is emphasized still further by the use of a large black bounce to camera right, so there is no fill to speak of: this bounce absorbs light both from the key and from the background.

- *There are often several number of routes to a given effect. Instead of trying to duplicate an effect exactly, why not try another approach?*
- *Remember the possibilities for selective (limited-area) bleaching, toning, etc.*
- *Consider using with films, printing mono negatives on colour paper, solarizing and more*



Photographer: **Ben Lagunas & Alex**

**Kuri**

Client: **Private Art**

Use: **Gallery**

Model: **Kate**

Assistant: **Isak de Ita**

Stylist: **Manolo**

Camera: **35mm**

Lens: **180mm**

Film: **Kodak Ektachrome EPT**

Exposure: **1/60sec at f/8**

Lighting: **Tungsten: 4 heads**

Props and set: **Black background;**

**colour introduced with gels**

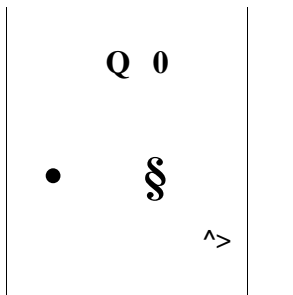

Plan View

## K A T E

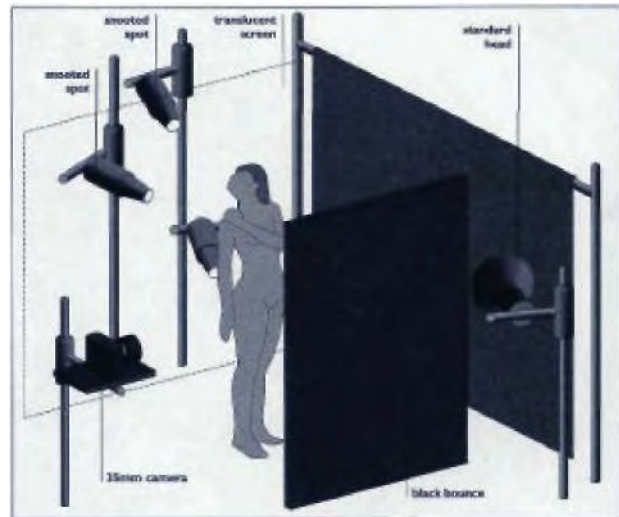

AGAIN AND AGAIN, PHOTOGRAPHERS DEBATE THE QUESTION OF LITERALNESS VERSUS INTERPRETATION, THERE IS NO DOUBT THAT INTERPRETATION IS RISKIER, BECAUSE A LITERAL IMAGE CAN BE JUDGED BY OBJECTIVE CRITERIA; BUT AN INTERPRETED IMAGE OFTEN HAS SOMETHING WHICH IS MISSING FROM A MERE LIKENESS.

The key light is a big, soft source created by shining three snooted spots through a translucent screen to camera left. Snooted spots may seem an odd choice until you realize that they allow the accurate placement of diffused light: the effects obtainable are quite different from what one would get with a large, uniform diffused light source. A black bounce to camera right darkens the side of the model which is away from the light, while a fourth light introduces just enough light to the background to differentiate the model's figure from it. Despite the differences in technique, this resembles some of Brandt's pictures taken with an ultra-wide lens on large format.

- *Different focal length an out-of-focus image in different ways*
- *Dramatic side lighting is often most effective with deliberately out-of-focus images*

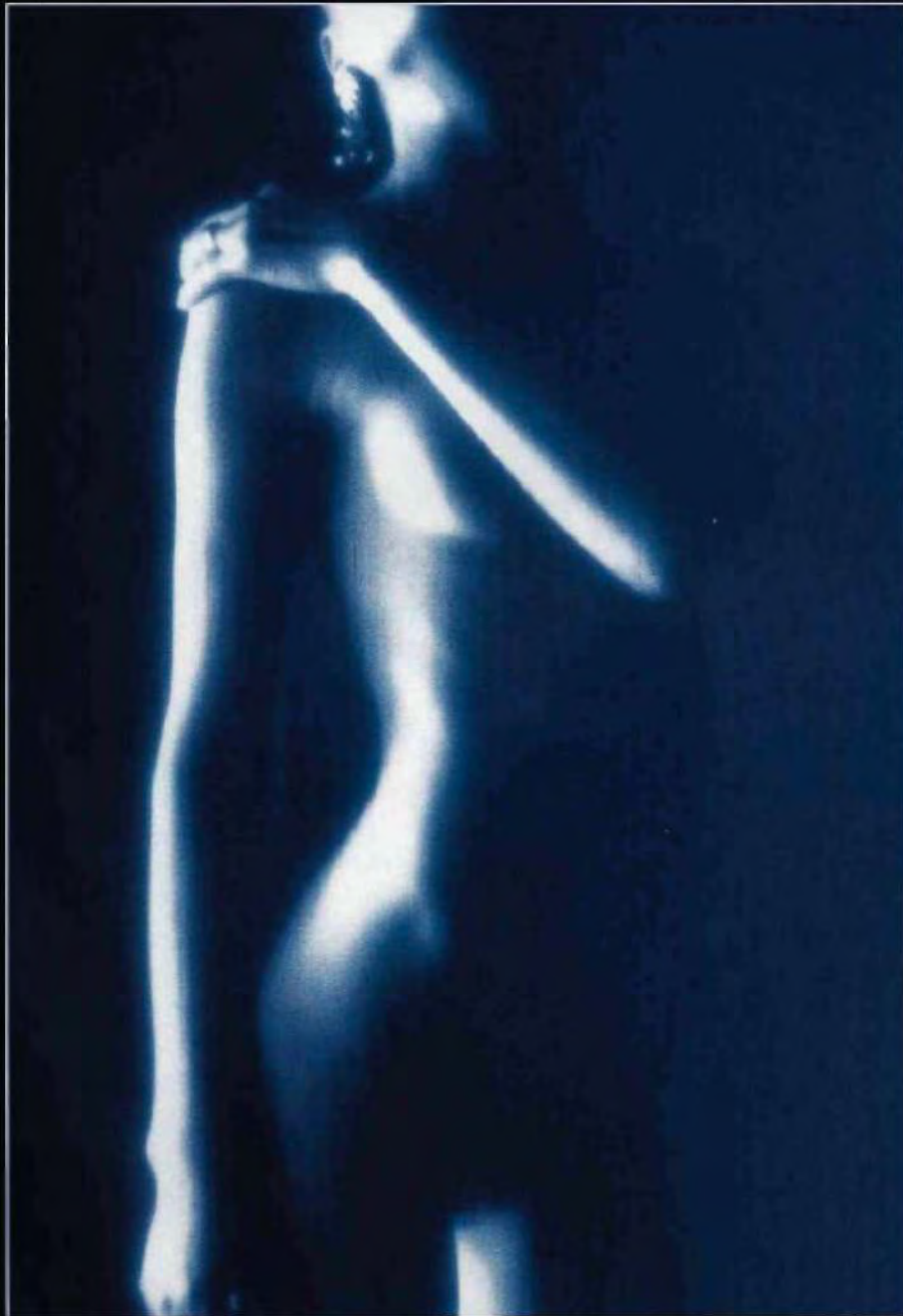

Photographer: **Ben Lagunas & Alex**

**Kuri**

Client: **Private art**

Use: **Gallery**

Model: **Andrea**

Assistant: **Isak de Ita**

Stylist: **Michel**

Camera: **4x5in**

Lens: **210mm**

Film: **Kodak monochrome; image subsequently coloured**

Exposure: **f/16**

Lighting: **Electronic flash: 4 heads**

Props and set: **Dress, mannikin**

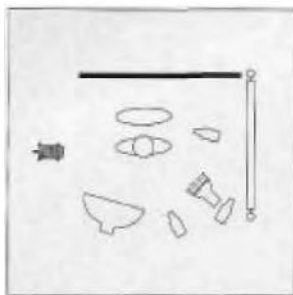

Plan View

## MANIKI

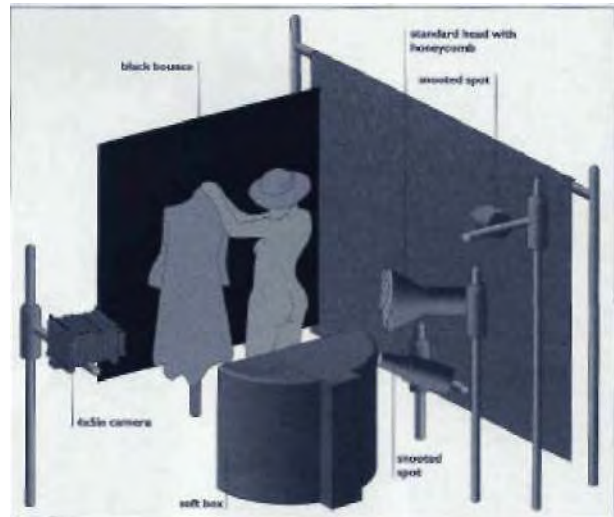

PARADOXICALLY, PHOTOGRAPHY CAN OFTEN SAY MORE ABOUT A SUBJECT (AND SAY IT MORE REALISTICALLY) BY MEANS OF CONTRIVANCE AND ARTIFICE THAN CAN BE SAID WITH A LITERAL LIKENESS USING ULTRA-REALISTIC COLOUR FILMS.

This is a monochrome image which has been toned, dyed and hand-coloured, but it manages to create a dream-like atmosphere which would be very hard to convey with a more conventional image.

The lighting from camera right is highly directional: a standard head with a honeycomb back lights the model very slightly (look at the shadows) while a soft

box softens the directionality of the light slightly. A third light, this time a snooted spot, grazes the background to create the light patch above the model's head while a fourth (a snooted spot again) differentiates the side of the dress from the very dark background. A black bounce to camera left emphasizes the-directionality of the lighting, ensuring that there is no fill to speak of.

- *Some photographers never use black bounces; others use them all the time. What could they do for your pictures?*
- *Use extra effects lights to differentiate small areas such as the side of the dress*



Photographer: **Mike Dmochowski**

Use: **Self promotional**

Model: **Dawn (who also acted as stylist)**

Camera: **35mm**

Lens: **200mm with warming filter**

Film: **Kodak Ektachrome EPP**

Exposure: **f/11**

Lighting: **Electronic flash: 1 head, filtered**

Props and set: **Gold body paint, black velvet, black paper**

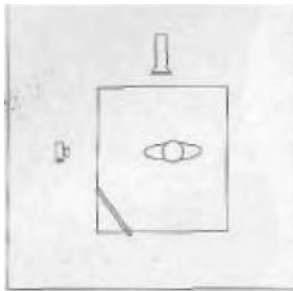

Plan View

## G O L D C L O S E U P

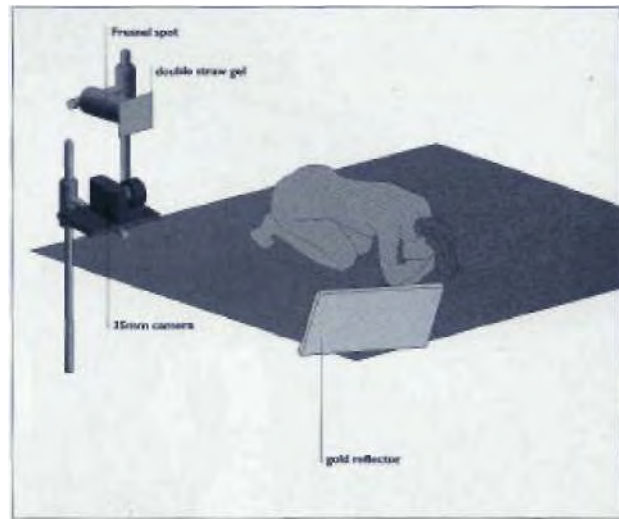

THERE ARE NO FIXED BOUNDARIES IN PHOTOGRAPHY. IS THIS A CLASSICAL NUDE? AN EXPERIMENT? AN ABSTRACT? FOR THAT MATTER, SOME WOULD NO DOUBT RAIL AGAINST IT BECAUSE IT DEPICTS THE NUDE HUMAN FORM. BUT THE DEFINITIONS DO NOT MATTER. IT IS A GOOD PHOTOGRAPH.

The model is painted gold with body-paint (size not recorded) about 30cm (12in) from the floor. A Fresnel flash to camera left is the key, and indeed the only, light. It is filtered with a double straw gel, and sits about 30cm (12in) above the floor, some 120cm (4ft) from the model. The fill comes from camera right, a gold reflector

- *Black velvet photographs about a stop darker than black seamless background paper*
- *Gold can be intensified by colouring the lights; by filtration over the camera lens; by film choice; by exposure; and by push processing*

(size not recorded) about 30cm (12in) from the model. A warming filter over the lens adds still more to the intensity and warmth of the gold - and it is interesting to speculate what effects might have been obtained with other film stocks.





Photographer: **Peter Goodrum**  
 Use: **Portfolio**  
 Model: **Jo Rowden**  
 Camera: **4x5in**  
 Lens: **90mm**  
 Film: **Kodak Infrared**  
 Exposure: **32sec at f/6.8**  
 Lighting: **Available light**  
 Props and set: **Location: Brean Down fort**

## I N F R A R E D    N U D E

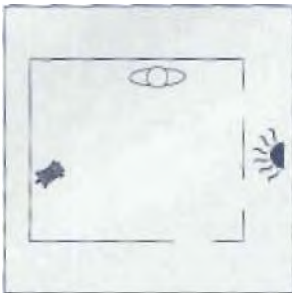

Plan View

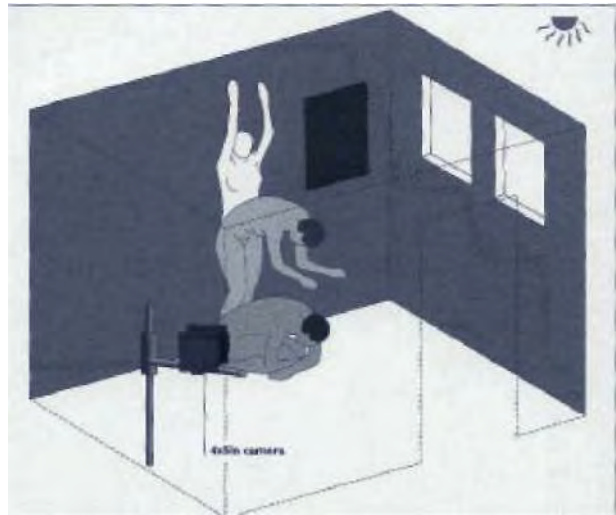

OLD SCHNEIDER ANGULONS ARE NOT SUPPOSED TO BE USED WIDE OPEN: THEY ARE NOT SHARP UNTIL ABOUT F/16. INFRARED IS NOT NORMALLY THE FILM OF CHOICE FOR NUDES. NOT MANY SHOOT NUDES ON 4X5IN.

- *Infrared can give impressive Pare and halation*
- *Pictures involving movement may need a good deal of rehearsal*
- *Polaroid tests are invaluable for checking the effects of movement*

Peter Goodrum let none of this stand in his way. This picture was shot purely by available light, from the two window apertures and a door behind the camera. At the beginning of the long exposure, the model was curled up in a ball on the floor. Next, she stood up so that her legs were more or less in the position recorded, but her body was at right angles

to the wall: she was bowed at the waist. Finally, she straightened up, but moved her arms and head quite vigorously so that they would not record at all.

The flare around the windows is characteristic of infrared materials, which give a sort of liquidity to the light, and the effect is accentuated by the softness of the lens when used wide open.

**Photographer's comment:**

*I made the print on Cotman watercolour paper coated with Silverprint Cold Tone emulsion, over-exposed a couple of stops and then bleached back before toning in Rayco Varitone Sepia.*

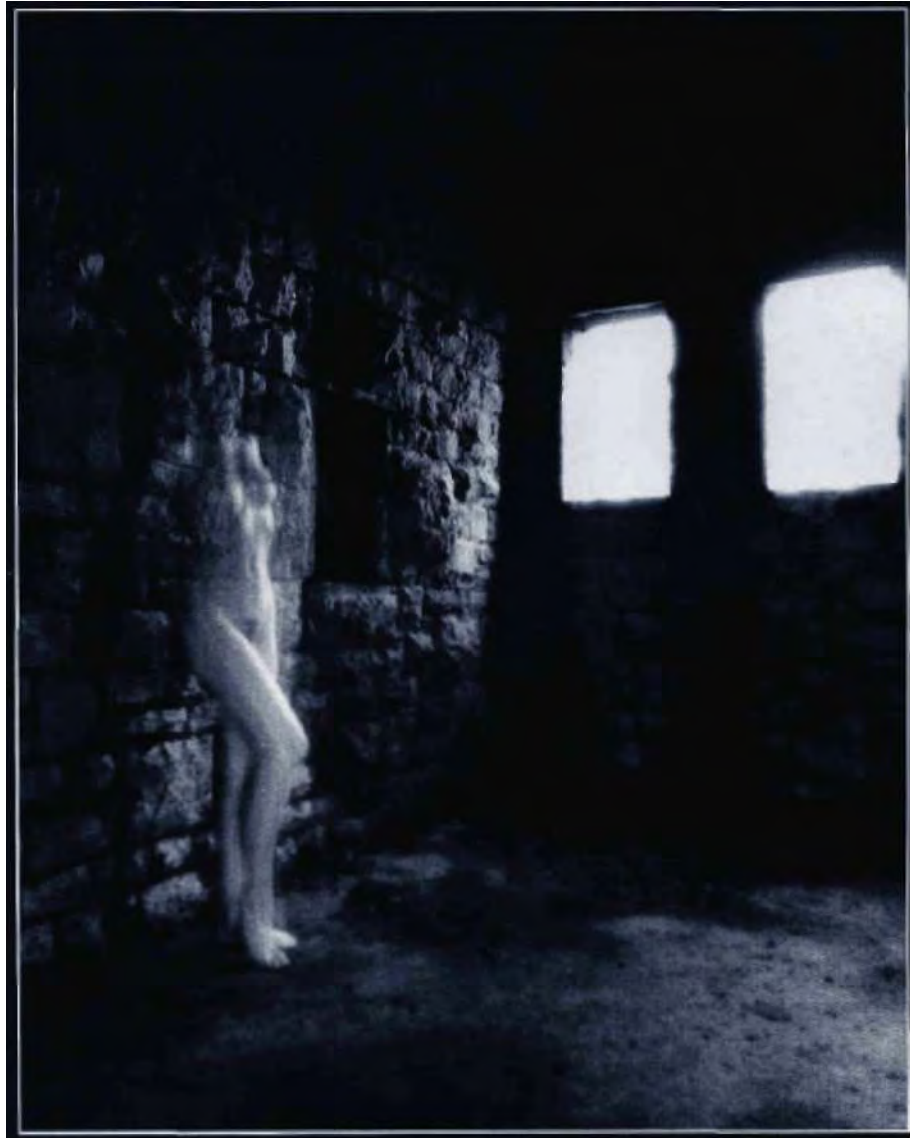

Photographer: **Rod Ashford**  
 Use: **Personal work, later sold as a book cover**  
 Model: **Geraldine Barrett**  
 Camera: 35mm  
 Lens: **70-21 Omm**  
 Film: **Ilford FP4**  
 Exposure: **f/11**  
 Lighting: **Electronic flash: 1 head**  
 Props and set: **Sunflower**

## GERALDINE AND THE FLOWER

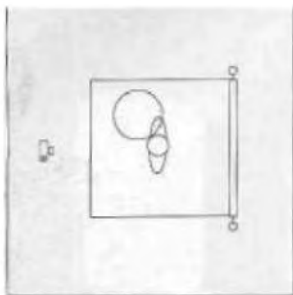

Plan View

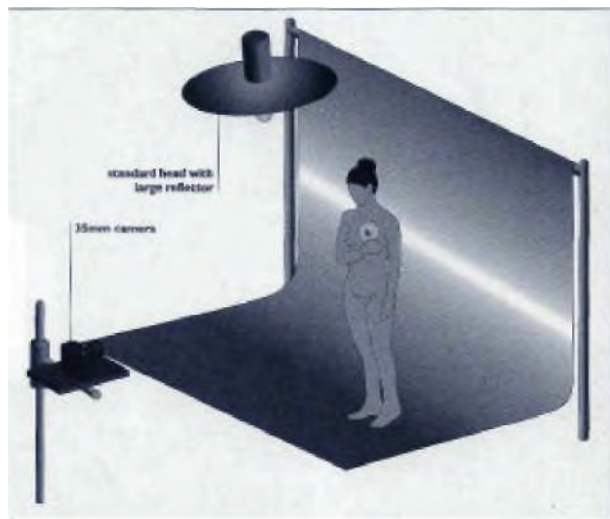

RODASHFORD IS FOND OF HANDCOLOURING, ALTHOUGH, AS HIS WORK DEMONSTRATES, HAND COLOURING IS MOST EFFECTIVE IF YOU HAVE A GOOD PICTURE TO BEGIN WITH. IT ALSO HAS AN AFFINITY WITH SEPIA.

There is only one light in this picture, a single large-reflector head set high and to the model's right (camera left): from the shadows, you can see quite clearly where it was. The quality of this light, sold as a 65-degree reflector, is subtly different from that of a soft box: it is about 45cm

(18in) in diameter, and it is not highly polished on the inside.

There is no bounce at all to camera right because Rod wanted dramatic chiaroscuro, although he says, "I may have overdone this - I think I had to bring her left side up a little in printing".

- *Many good photographers are critical of their own pictures, even if those pictures receive unqualified praise elsewhere*
- *Naturalistic colouring of green foliage is not as easy as one might hope*
- *Half-close your eyes and note the distribution of tones in this picture; it is superb*

### Photographer's comment:

*This was sold as a poster under the name "Passion Flower" but I like my working title better.*

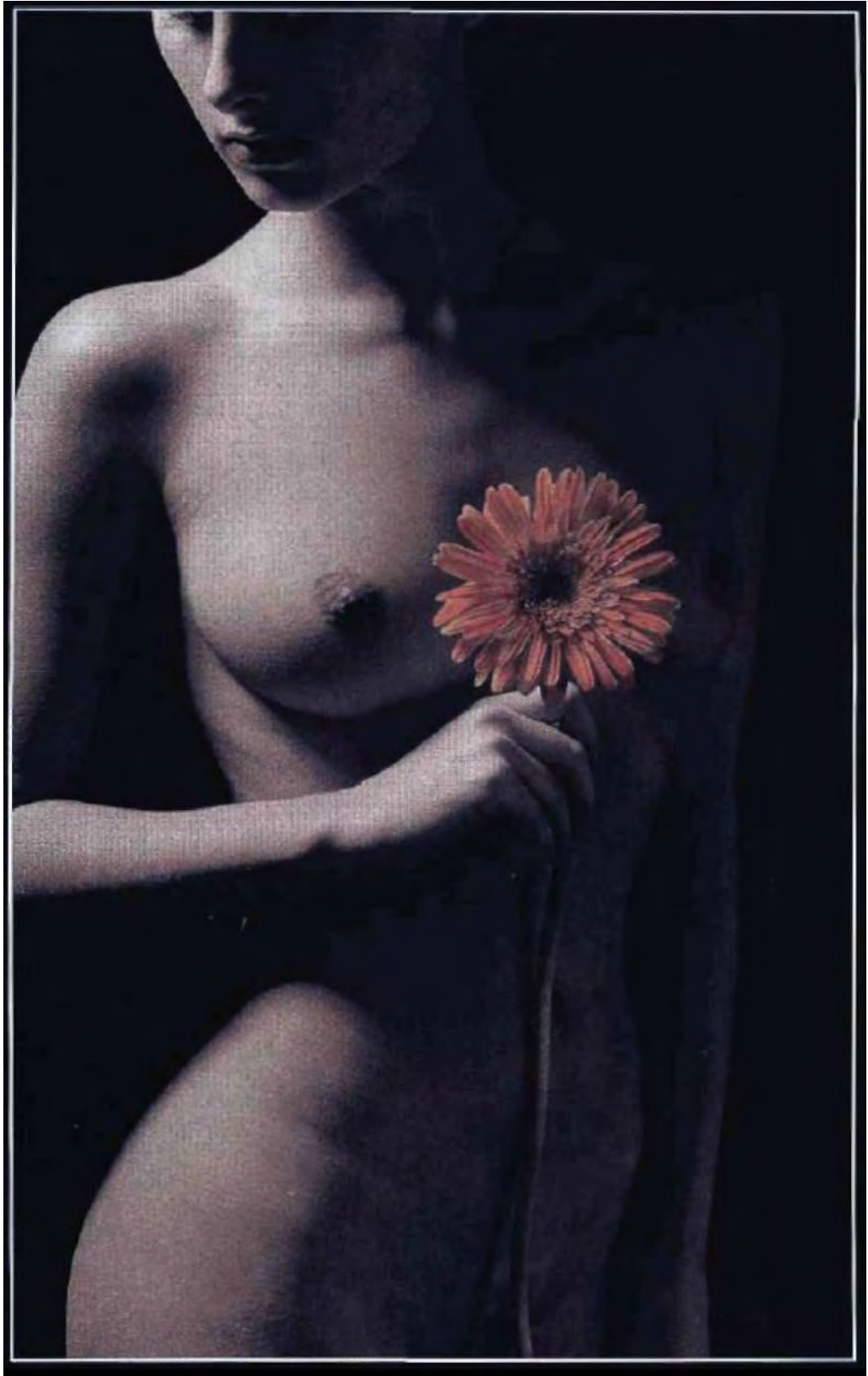

Photographer: **Guido Paterno Castello**

Use: **Self-promotion**

Model: **Telma Mercedes dos Santos**

Assistant: **Fernando Ribiero**

Camera: **6x6cm**

Lens: **50mm**

Film: **Kodak Verichrome Pan**

Exposure: **f/11**

Lighting: **Electronic flash: 3 heads**

Props and set: **White background paper**

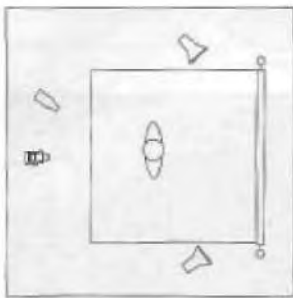

Plan View

## NUDE

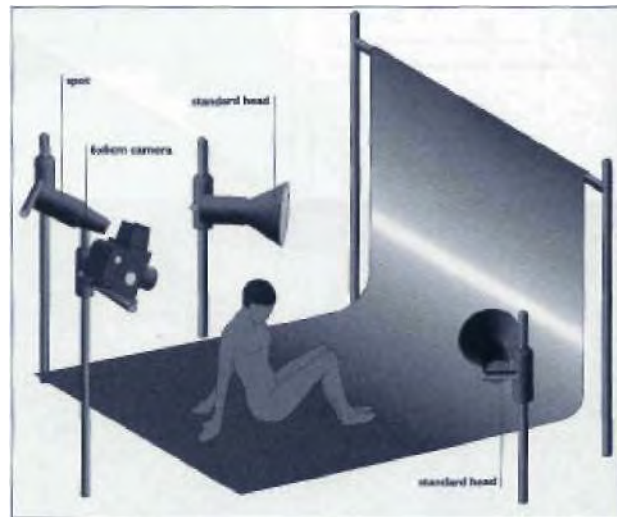

WIDE-ANGLE DISTORTIONS IN NUDE PHOTOGRAPHY HAVE BEEN EXPLORED BY MANY GREAT PHOTOGRAPHERS - BLLL BRANDT SPRINGS TO MIND - BUT THEY ARE VERY HARD TO DO SUCCESSFULLY WITHOUT LOOKING AWKWARD OR (WORSE STILL) GROTESQUE.

- *Extreme wide-angle lenses can create fascinating distortions*
- *Be relentlessly self-critical with distorted nudes; compare your work with the very best*
- *Note how many successful nude distortions make use of out-of-focus areas in the image*

A large part of the secret, as in most kinds of nude photography, lies in suppressing unwanted detail. Guido Paterno Castello achieved this by shooting on Verichrome black and white film; inputting the resultant image to a Power Mac; and then shooting the image off the screen using colour film.

The dramatic lighting emphasizes the graphic shape of the model's pose and

makes her shadow an integral part of the composition. It is simple but effective: two standard heads on the background for a classic high-key effect, and one spot on the model herself from high on the camera left. The unusual camera angle makes it unclear at first whether the picture should be "portrait" (as printed here) or "landscape", with the model's head to the right and hands to the left.

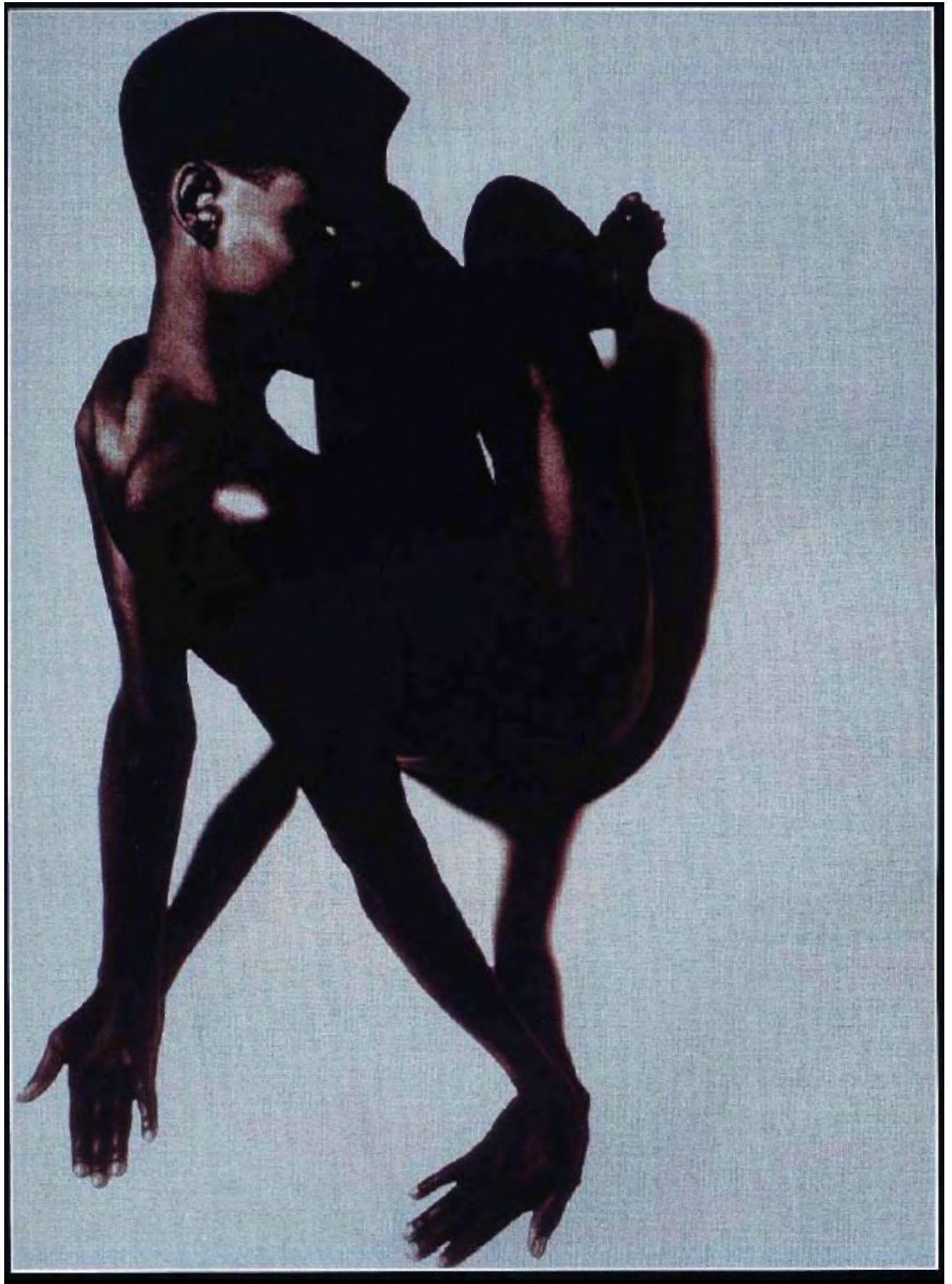

# EROTICA

**The word 'erotic' derives from Eros, the Greek god of love, who is also known within Roman literature as Cupid. Eros is the son of the Greek goddess of love, Aphrodite (or Venus, in the Roman tradition).**

Eros traditionally has a dual nature: he is young and beautiful, but also playful. In the guise of Cupid he is often blindfolded and so his victims are chosen at random the targets of his arrows of passion.

Eros is symbolic of carnal desire. The fact that he is blindfold represents the random factor - how different people are struck in different ways by different sources of stimulation. What appeals to any one person is a very individual thing, what they find interesting and attractive, and, indeed, erotic, may be very specific to themselves, but some images will cover a broad spectrum of people. The point and purpose of erotic imagery is of course to appeal to the carnal interests of the viewer and in this respect the images must have that certain frisson, or sexual charge, in order to hit their mark.

It is never easy to please a potential audience because every person will like and be stimulated by something different. Although there are some themes that appeal to a wide range of people, some will have more esoteric tastes. Erotic imagery often explores what may for others seem quite unlikely areas of erotic interest. This is the point at which the genre specialises into particular fetish themes. There is room for the work of both the generalist and the specialist in erotic photography. The aim of erotica is, of course, to "tickle the fancy", as the phrase has it. What is surprising is that many may not even know they find something erotic until they see it; in this respect the viewer has to depend on

the imagination of the artist/photographer for imaginative stimulus and fresh ideas, especially since many areas of erotic imagery have become so familiar as to be stale clichés. There is therefore always a demand for new approaches, ideas and new styles of image.

The erotic shot has to work as a picture in its own right. Although it is tempting to think that the power of an erotic shot derives primarily, if not solely, from its subject matter, it is important to recognise that composition, lighting and the fundamental elements of form, line, tone, texture and colour all contribute immensely to the overall impact and success of an erotic shot.

The lighting and set can and should be used to establish a mood. The same subject matter could be presented in many different ways: even the same model in the same pose, the same setting and the same costume can be photographed in different ways to give a whole range of entirely different moods, purely by use of lighting. A soft focus low-key set-up will give the dewy romantic look at one end of the spectrum, while the brash, stark highkey "in your face" effect is at the other.

## **The uses of erotic photography**

Sex sells. Powerful and sexy images of beautiful people are at the core of much advertising, and so the skills of the photographer of erotica are often called for. It is essential in this situation to have a good understanding

of mood: the moods that the client wants as well as the technicalities of how to establish or create any given mood with the lighting.

Another major use for the erotic shot is the ever growing market for fine art photographic post cards, wall posters and prints. In this case the shot is essentially decorative, whether decorating the shabby walls of a student residence or the intimate corners of a high-class hotel or restaurant. But as well as being an item of decoration, the shot is also a commodity. It will only get the chance to serve its decorative purpose if it succeeds as a commodity. For this market the general subject matter has to be pitched for broad general appeal and it can not be too explicit if it is to go on sale in high-street stationers, art shops and so on.

At the other extreme is the specialist market, where the subject matter will appeal to a much smaller audience with a very particular and defined kind of taste. It is also likely to be sold in a more specialist environment and may well have a more overtly sexual content.

The key is to produce the appropriate image for the purpose. Defining and understanding the brief is essential if the photographer is to produce the image required and if the client is to get the "feel" and style of picture they have in mind. With a subject area such as erotica it may be particularly difficult for a client to identify the exact look they want so it is all the more important for the



photographer to approach this varied and complex subject with care and diligence.

### **Studio or Location?**

Shooting on location can be a tricky business where an erotic shot is concerned. An outdoor location is risky if the photographer, and indeed the model, wish to work unhampered by the astonished and curious gaze of passers-by. It is important to create a good working atmosphere and to build up a rapport with the model and this may generally best be done in a private and intimate atmosphere away from the prying stares of outsiders. If the model is not at ease, nothing will make him/her appear so in the final shot.

In some situations though a location may add to the context or offer the quality of daylight that will work best. It can also contribute a provocative element by the very fact that it is set in an apparently public place.

The studio, on the other hand, offers the immediacy that may be lacking on location as well as full control over the lighting. This may well be the key factor when deciding how and where to arrange the shoot.

### **Film, cameras, and lenses**

Erotic photography is more than likely to involve a considerable amount of bare skin and variety of clothing fabrics from shiny PVC and leather at one end of the spectrum to fine lace and chiffon-type fabrics at the other. The choice of film stock is bound to be influenced by the exact nature of the subject and composition.

Flesh tone studies are an important exercise for the photographer who wishes to work seriously in this area. There is such a vast array of film stocks available on the market that it

is essential to experiment and see how different stocks work with the almost endless variety of human skin tones and colours. In the not so distant past, a certain amount of filtration was often required to achieve good neutral skin tones but film stocks today are more neutral. More film stocks also offer a naturally warm tone, a great boon for working with bare-flesh subjects.

A current vogue is "incorrect" processing techniques, more commonly known as cross-processing; that is, processing C41 colour negative stock in an E6 transparency process, and vice versa. Common results of this are increased contrast, more vivid and intense colours, often a cyan tinge in the low-lights, amongst other (sometimes somewhat unpredictable) features. Another technique is to put films such as Ilford's XP2 black and white stock, which is normally processed in C41 chemistry, to give black and white or sepia tone tints, through a pushed or pulled E6 process, to give instead a blue or green tinted black and white transparency.

The choice of camera format and lens for the shoot will be determined by the end result required. For example, if a grainy look is wanted, a 8x10 inch format would be an unlikely choice since the strength of this format is its ability to produce a large, crystal-clear transparency. That is not to say that it would not be possible to achieve a grainy image in that format, but much more convenient would be the choice of a 35mm camera. On the other hand, it is important to remember what the use of the image will be beyond the photography stage. If the transparency is to be used for a poster billboard, for example, it is going to be enlarged a great deal and it may then be

preferable to work with an initially less grainy but larger image via an 8x10 inch, in the knowledge that the grain will inevitably become more apparent by the extreme enlargement. As ever, the circumstances and requirements =N will dictate the choice of camera and technique.

The same can be said of lenses. A wide-angle lens will accentuate the length of legs and may elongate the image, therefore making a model look slimmer; if this is what is required it is important to know which tool will produce the effect. Alternatively, it may be that a close-in and intimate look is wanted, in which case a long lens may be a more obvious choice for filling the frame and reducing depth of field without crowding the model, but allowing the photographer to work from a greater distance. This would also make it easier to light the subject. While a similar effect might theoretically be achieved by working in closer proximity and using a standard lens, neither the model nor the lighting are going to be so comfortable if the photographer is too close.

### **Clothes, props and make-up**

The essence of many an erotic shot rests on clothing and costume. The array of possible costumes is endless: lingerie, stiletto shoes, stockings, suspenders, even chain-mail and armoury for a bondage-type image all come into their own in the erotic image. Make-up is equally important and can establish anything from an innocent, youthful, natural look (which is in fact anything but un-made-up), to the glossy and extrovert look of the raunchy sex queen.

The work of the make-up artist is crucial. The make-up must be expertly applied and well judged in relation to

the mood of the image - in fact careful attention must be paid to all aspects of the styling. The clothing has to be in keeping with the look of the model, the hair and make-up in order to establish the right feel.

The choice of props is another crucial factor. Not only must the right item be selected for the shot, but it must be exploited in the most effective way. In erotic photography, that often will be the least obvious way, as in Salvio Paris's "Unhard rock!" where a model wears a garter belt as a mask. Many erotic shots will be to some extent narrative images, suggesting an ongoing situation and scene, and the props will be vital. Again, the viewer depends on the photographer's imagination to present something stimulating and unexpected, and using a familiar prop in an unfamiliar way can have this kind of impact.

#### **Lighting equipment and mood**

There are no hard and fast rules about lighting erotic shots, but establishing the right mood for the shot is crucial. The photographer may need access to a whole range of lighting equipment to facilitate creating that mood.

The beauty of the hard source is that it can be adapted to become a soft source whereas the reverse is not so easy; the hard source is a more versatile starting-point, therefore. Standard heads with soft box attachments are always a good investment, along with a range of modifying items such as gels, gobos, barn doors, and so on. These attachments need not be expensive. In many cases home-made improvisations can be just as effective as professionally made items; for example using cut out paper for gobos, and coloured fabric or coloured paper as a reflector instead of more expensive gels. (It is

important to remember, though, if improvising with equipment to be used near light sources, safety must always be maintained: lights can get extremely hot and fire hazards must be avoided at all times.)

#### **The erotic session**

The "erotic session" may be a rather misleading description for a shoot for an erotic image. It is not meant to imply that the shoot is itself intended or expected to be primarily an erotic experience; the subject matter is by no means any excuse for the photographer (or indeed the model) to expect anything other than a completely professional method of working. An intimate atmosphere could be a great help during the shoot, but this has to be established according to well-defined methods of working, whereby both the photographer and the model know what to expect of each other and have agreed on a way of achieving the desired result. It is important for the model to be at ease, and developing a rapport with the model and a working intimacy at just the right level is a very subtle skill in itself. The photographer must judge what will put the model at ease, what will make the shoot go well, and what will enable the model to give the performance required in front of the camera. It is essential to get the parameters agreed before the shoot begins; there is obviously a great deal of vulnerability implicit in an erotic shoot, and this has to be dealt with professionally.

The presence or absence of other crew may or may not help to establish the correct balance between the necessary professional approach and the all-important intimate atmosphere that will surely show through on the film. Again, consultation with

the model is important and a mutually agreeable arrangement must be arrived at.



EROTIC FANTASY

**08**

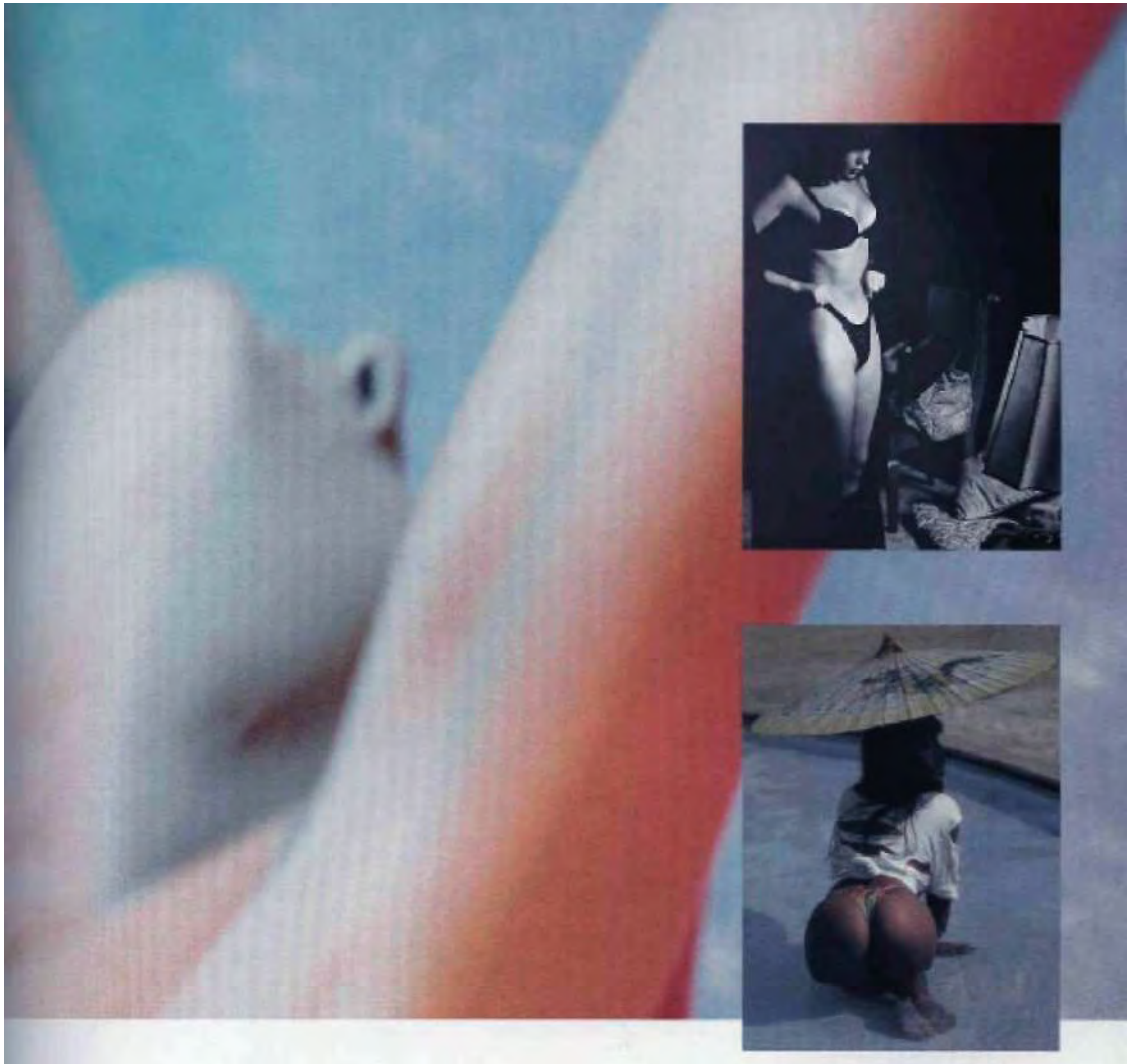

This chapter shows a very wide range of influences, from Man Ray to Picasso. There are definite similarities in the elements of surrealism and the unexpected in many of the shots. An aspect of fantasy is that it has little or nothing to do with reality, and many of the shots in this chapter have either no context or a quirky, surreal one, giving free rein to the imagination of the viewer.

At the other extreme is the more blatant and ostentatious realism which is more an expression of how one might wish reality to be: not a fantasy in the sense of the intangible and imaginary but, rather, as an almost attainable version of reality; a form of wishful thinking that is brought to life by the photographer.

Photographer: **Craig Scoffone**

Use: **model portfolio test**

Model: **Heather**

Camera: **35mm**

Lens: **45-125mm**

Film: **Pan-X**

Exposure: **not recorded**

Lighting: **available light**

Props and set: **light grey wall**

## HEATHER



Plan View



THIS SHOT USES NATURAL LIGHT. THE STRAIGHTFORWARD SIMPLICITY OF THE MODEL'S EXPRESSION AND HAIR AND MAKE-UP STYLING CONTINUE THIS THEME OF A NATURAL LOOK, THOUGH THE CLOTHING HAS BEEN CHOSEN TO ADD AN EROTIC ELEMENT TO AN OTHERWISE QUITE INNOCENT FEEL.

The sunlight enters the studio from the large windows to the left of camera, and the model stands sideways on to the window and fairly close to the light grey back wall. The tightness of crop, combined with her proximity to the wall, means that little or no shadow is visible on the wall behind her. Although this is a side-lit shot, there is no strong sense of directionality because of the diffuse nature of natural and even north light. This is evident in the low level of modelling across the curves of the model's features.

### **key points**

*A bright blue north sky can have a colour temperature of up to 18,000° Kelvin*

*It is possible to get a north light simulator which is obviously an indirect source*

### **Photographer's comment:**

*This was a portfolio test shot for Heather. It shows good use of the beauty of north light.*

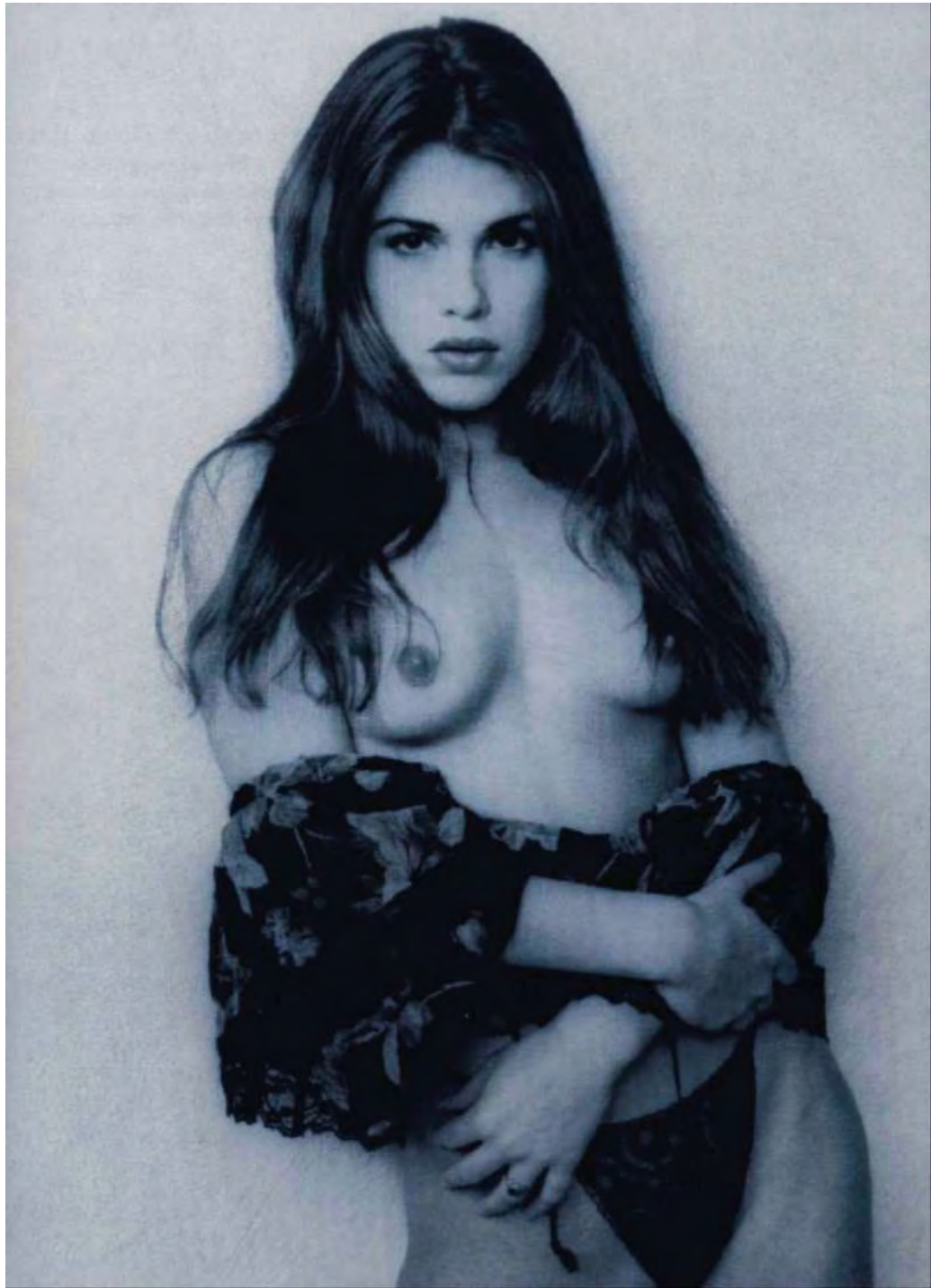

Photographer: **Antonio Traza**  
 Camera: **6x7cm**  
 Lens: **127mm and anamorphic lens**  
 Film: **Kodak EPR 100 ISO**  
 Exposure: **1/30 second at f/8**  
 Lighting: **electronic flash and tungsten**  
 Props and background: **hand-painted background reminiscent of Picasso**



Plan View

## UNTITLED

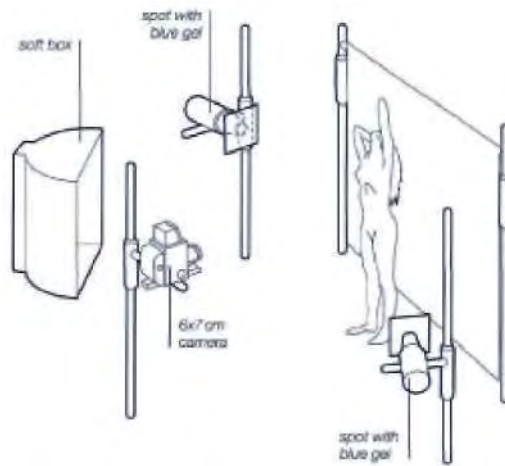

IN THIS SHOT THE MODEL APPEARS TO BE LYING BACK, IN FACT, THE PHOTOGRAPHER HAS STOOD THE MODEL VERY CLOSE TO FILE BACKGROUND AND HAS CHOSEN A WERY LOW CAMERA ANGLE WITH THE ADDITION OF AN ANAMORPHIC ADAPTER.

"The lighting was easy," says Italian photographer Antonio Traza. "Two tungsten heads (modified by a red and a blue gel), one at either side of the model, create the ring light necessary for the colour effect on the lower edges of the body. The flash with small soft box freezes the image and softens the shadows. The tungsten gives form and colour and creates the white lines around the model."

### **key points**

*The anamorphic lens can be a little difficult to use because of the narrow depth of field and focusing ring in the lens*

*Mixing tungsten and flash can be a fun way to create secondary colours*

### **Photographer's comment:**

*This picture was inspired by Picasso's "Demoiselles d'Avignon". I wanted to create that "stretch" in the image for which I used an anamorphic lens. The background and gels are reminiscent of the "blue" and "rose" periods of Picasso.*





Photographer: **Ben Lagunas and Alex Kuri**  
Use: **gallery**  
Assistans: **Isak, Christian, Paulina, Janice**  
Art director: **Ben Lagunas**  
Stylist: **Vincent St Angelo**  
Camera: **6x6cm**  
Lens: **210mm**  
Film: **Kodak Tmax**  
Exposure: **1/125 second at f/16**  
Lighting: **electronic flash**



Plan View

## WAITING FOR YOU

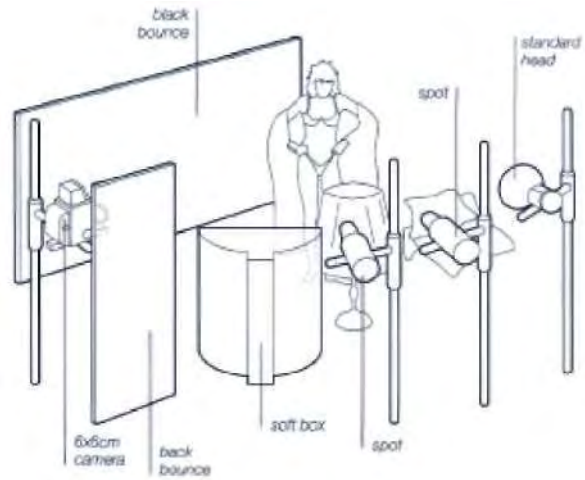

THIS IS A CLASSIC EXAMPLE OF A CAREFULLY CRAFTED STUDIO SHOT MADE TO LOOK LIKE A LOCATION, TINE SET DRESSING IS IMMACULATE, WITH CLOSE ATTENTION TO DETAIL ESTABLISHING AN AUTHENTIC FEEL.

The model stands against a dark background with a black panel behind her. Another black panel to the right of the camera prevents any spill light from falling on the lens. To the right of this panel is a soft box which gives fill light. Two focusing spots key the model's body, and a standard head illuminates the area behind her to give the tiniest amount of "lift" and separation.

The dramatic chiaroscuro look creates a romantic fantasy mood. Classically, the chiaroscuro effect consists of a single light used in contrast with darkness, but this shot is a good example of how to make a series of lights appear to be one source. It takes tremendous skill and judgment to pull this off.

### **key points**

*It is important to anticipate any possible problems with flare and to flag effectively to control this*

*Foreground props can add more shape and interest to the composition*



Photographer: **Marc Joye**  
 Model: **Margret**  
 Camera: **35mm**  
 Lens: **35mm**  
 Film: **Kodak Tri X**  
 Exposure: **1/60 second at f/11**  
 Lighting: **electronic flash and sunlight**

## NUDE ON STAIRCASE



Plan View

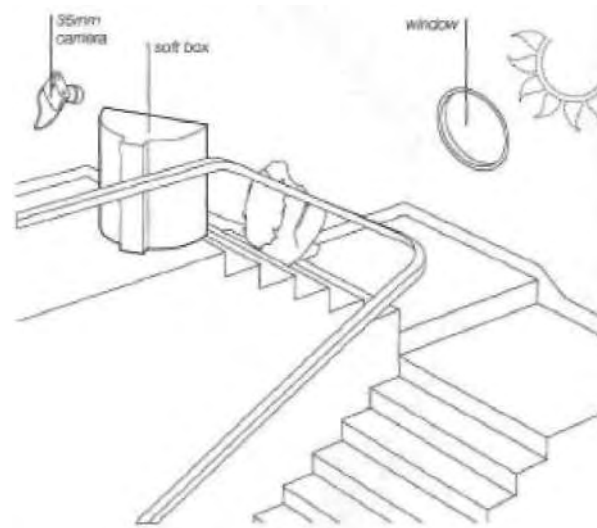

AN UNUSUAL VIEWPOINT OF AN UNUSUAL POSE CAN CREATE CONSIDERABLE INTEREST, CHALLENGING THE EYE TO WORK OUT EXACTLY WHAT IT IS LOOKING AT.

### **key points**

*Hand-tinted and self-sensitised paper images should be re-shot on to transparency as a precaution against fading or damage to the materials used*

*Contrast can be controlled to the nth degree by use of a light meter and judicious adding to or modifying of sources*

This graphically engaging sense of disorientation is enhanced here by hand-sensitised paper demonstrating strong brushstrokes and bold hand-tinting.

The small window, facing the camera but just out of view at the top of the image, with harsh sunlight streaming through, naturally gives high contrast. To counter this, Marc Joye

has introduced a soft box behind the camera, opposite the window, to reduce subject contrast.

The sunlight gives the hard edges to the stairs. The strong lines of the staircase, handrail and model pose combine to reinforce the expert graphic composition, which has become Marc Joye's signature.

### **Photographer's comment:**

*Photographed on 35mm Tri X film and printed on designer paper made sensitive with Fuji Art emulsion and hand-coloured on the stairs and handrail with red water-colour dye.*



Photographer: **Frank Wartenberg**

Use: **publicity**

Camera: **6x7cm**

Lens: **360mm**

Film: **Fuji Velvia**

Exposure: **not recorded**

Lighting: **electronic flash**

## **BLACK WOMAN TONGUE**



Plan View

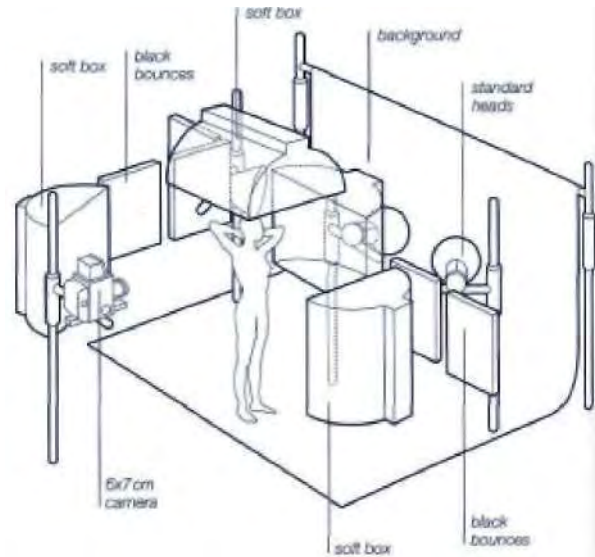

THE MOST IMPORTANT ELEMENT IN THIS SHOT IS THE OVERHEAD SOFT BOX, WHICH HIGHLIGHTS THE MODEL'S LONG TONGUE.

The background is strongly lit by three standard heads providing a white even glowing backdrop. Overall light is supplied by a large soft box slightly to the left of the camera and a soft box opposite the model illuminates what is visible of the torso. Black panels

behind the subject make sure that the focus of light emanates from a very specific place. This shot also demonstrates that a balance to a composition can transform a strong shot into a very stunning and startling impactful image.

### **key points**

*Darker skins can be very absorbent of light, reflected light readings are essential*

*Light and shade is what photographic lighting is all about*

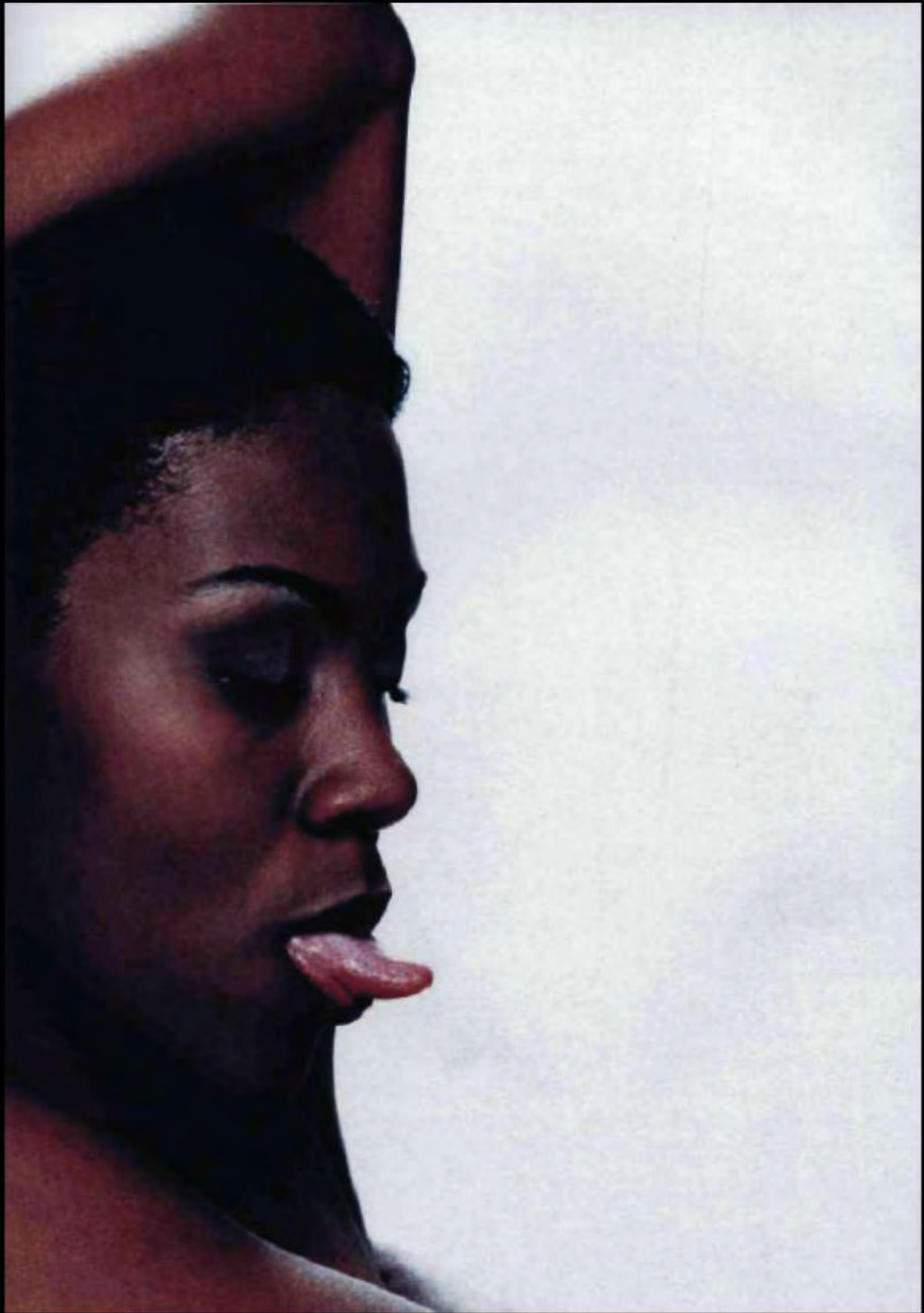

Photographer: **Bob Shell**

Use: **stock**

Camera: **35mm**

Lens: **90mm**

Film: **Fuji Provia**

Exposure: **not recorded**

Lighting: **available light with on-camera flash**

props and background: **parasol and pool**

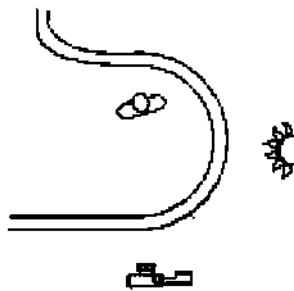

Plan View

## LIEU

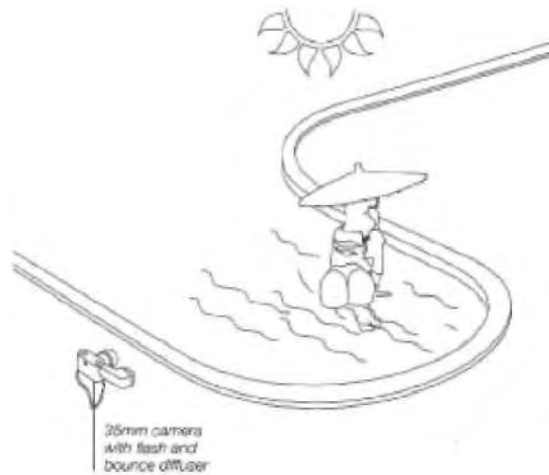

THE SUN IS BEATING DOWN ON THIS ORIENTAL BEAUTY AS SHE TAKES REFUGE UNDER A PARASOL AND TRIES TO COOL OFF IN THE POOL. BUT BOTH ITEMS ARE MORE THAN PROPS: THEY ARE, IN EFFECT, PIECES OF LIGHTING EQUIPMENT

The rippling water provides a mirror-like reflector below. The parasol diffuses the light from above giving a good amount of modelling to the curves of the model's body and emphasises the gleaming derriere as the focus of erotic interest.

The highlights on the shirt and position and depth of the shadow

indicate the position and intensity of the sun. Although it might seem odd to use a flash in such bright daylight, the bounced on-camera flash adds just enough fill-in to the face, which is in the most shaded area of the composition: note the texture in the dark mass of hair and deep, velvety eyes, which would otherwise be lost.

### **key points**

*Rippling water can be used as a gobo to create interesting light and shade, and of course texture*

*The parasol acts as a flag for the model's eyes: the shade it provides prevents her squinting against the brilliance of the sun*





Photographer: **Ricardo de Vicq de Cumplich**  
 Use: **exhibition**  
 Assistant: **Ednaldo de Sousa Ramos**  
 Camera: **4x5 inch**  
 Lens: **210mm**  
 Film: **Tmax 100**  
 Exposure: **f/32**  
 Lighting: **available light and light brush**

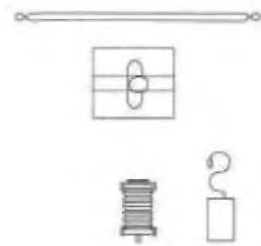

Plan View

## WOMAN

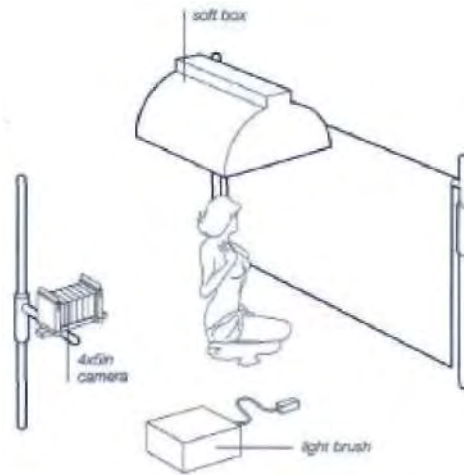

THIS SOLARISED LOOK IS REMINISCENT OF THE SURREALIST MOVEMENT OF THE 1930S AND THE WORK OF SUCH "GREATS" AS MAN RAY AND LASIO MAHOLY-NAGY.

### key points

*It is invaluable experience to emulate the work of the Great Masters*

*A comfortable model pose that can be held still for some length of time is very important for long exposures and light painting.*

In this instance, however, the glowing tones emanate not from darkroom technique, but from the use of a light brush. The initial exposure uses a large overhead soft box, which is further softened by a diffuser to ensure an extremely low-contrast look. The light brush work picks out areas on the upper edges of the torso for additional exposure, giving a silvery, surreal gleam to the skin.

It is interesting to compare the lower back and the profile of the face to see how different amounts and types of minuscule movement by the model lead to different results. The black line outline along the curve of the back represents a slight change of position between the flash and the light brush work, while the ghostly softness of the face and hands indicate greater movement during the light painting.

### Photographer's comment:

*This photograph was chosen to be in Graphics Photo 94 in the portrait category.*



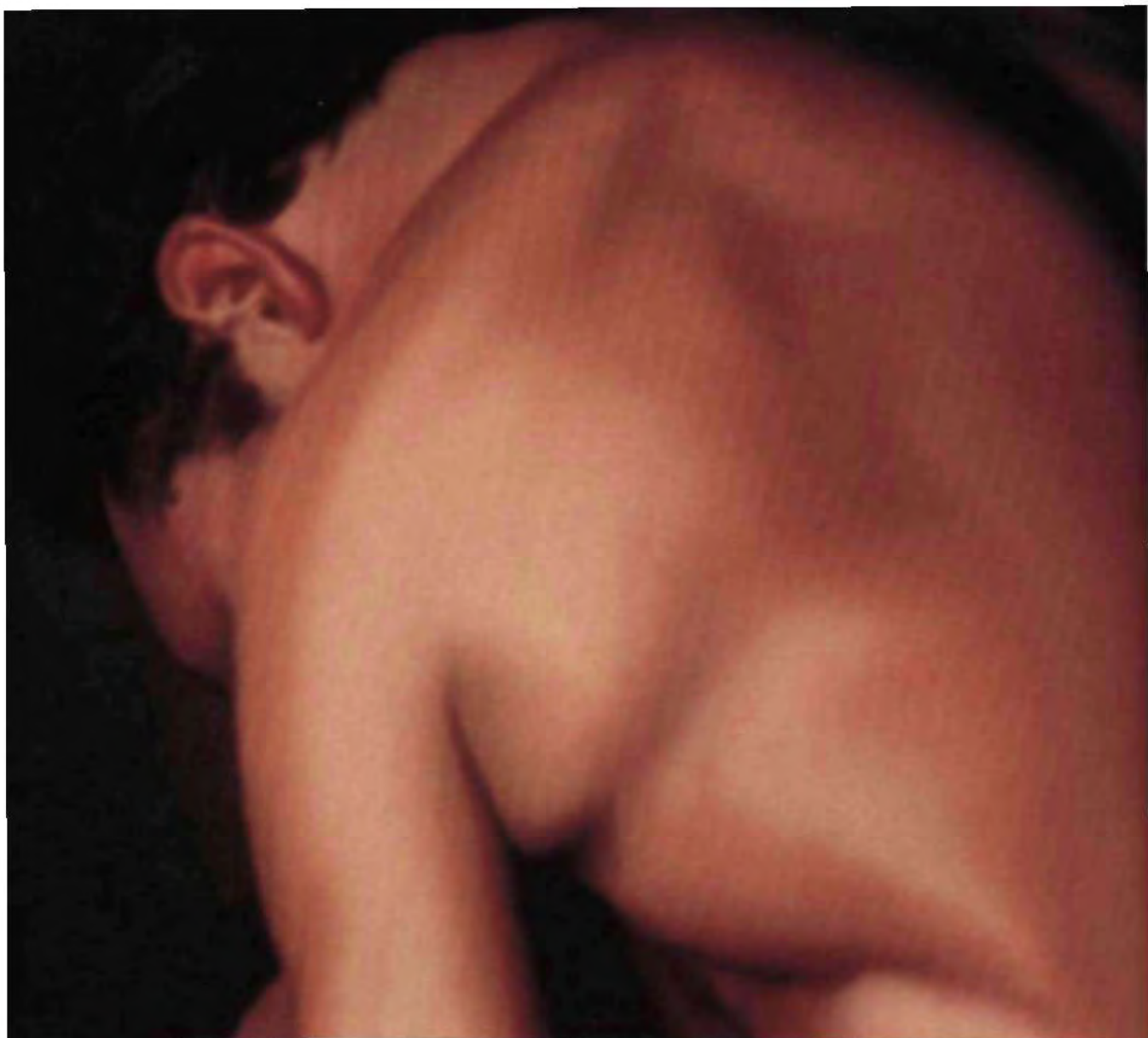

ABSTRACTS and

09

BODY PARTS

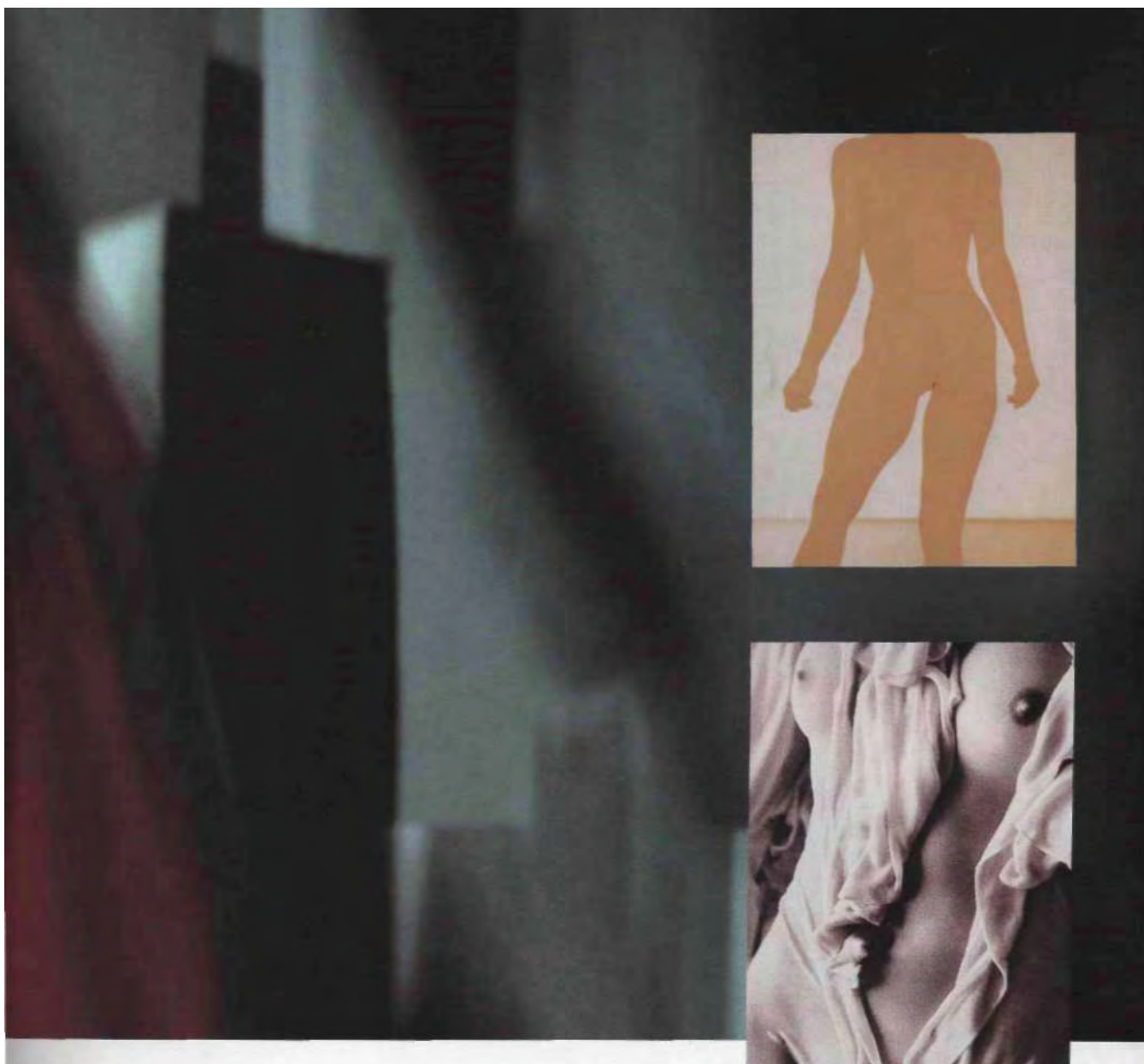

What makes a model-based image abstract? Looking at the selection of photographs in this chapter, one key element seems to be to depersonalise the shot by not depicting the head or face. This is a stark and clear-cut way of drawing attention to form rather than personality; to aesthetic composition rather than to emotive narration. Abstract experimentation also embraces a range of techniques for depersonalising the already anonymous body parts that are the subject of these studies. While some of the images here represent bodies in clear detail, choice of black-and-white stock, such as that favoured by Gerard de Saint-Maxent, is one way of distancing us from the model as a real person; use of silhouette and colour-wash techniques is another, as Craig Scoffone's work demonstrates. What is important, though, is the focus and concentration on the aesthetics - and the erotic charge - of body parts out of context.



# GREY ASH

photographer **Craig Scoffone**

**camera** 35mm  
**lens** 45-125mm  
**film** Agfa APX  
**exposure** not recorded  
**lighting** available light  
**props and background** white seamless paper

**Sunlight diffused above the subject was the only light source used for this photograph, yet basically it is as if the model is standing inside a giant soft box.**

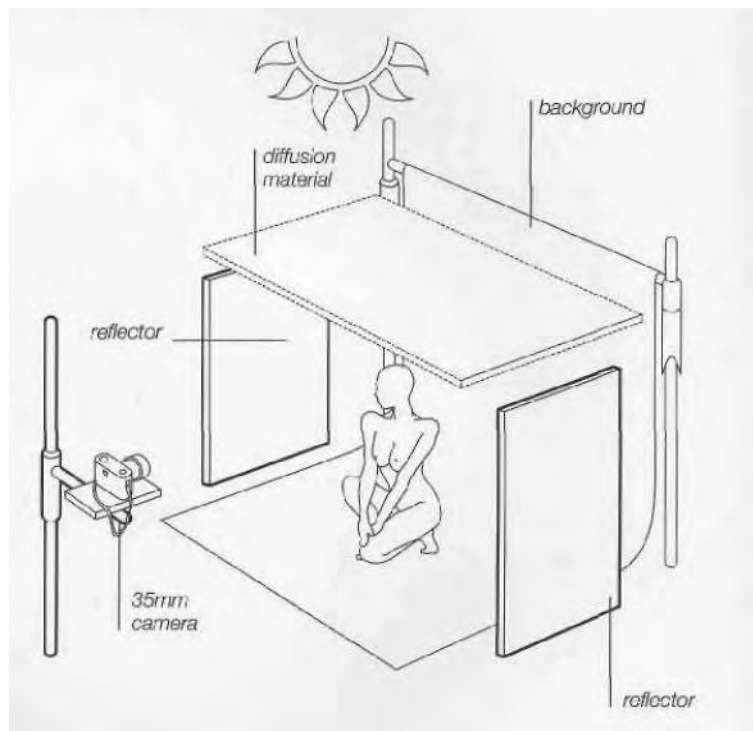
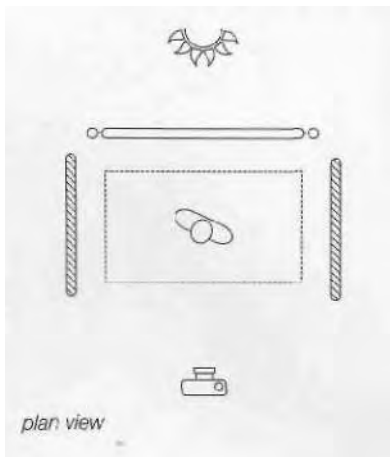

## **key points**

*The choice of slow film contributes to a low-contrast image*

*Down-rating a film combined with pull-processing will generally give more shadow detail*

The white paper background and the white reflectors at each side comprise the walls, while the silk of the "soft box" is made up of the diffusion material suspended above the model. But instead of light emanating from the soft box, it is filled with natural overhead sunlight.

The only really dark area is the neck, and this is caused by the shadow of the chin. The illusion of a weathered, textured statue, created by the use of ash on the model's body, is enhanced by shooting in black-and-white and by keeping the lighting very soft.

## **photographer's comment:**

*Ash from my fireplace was used to cover the subject's body and make the surface appear like a statue.*

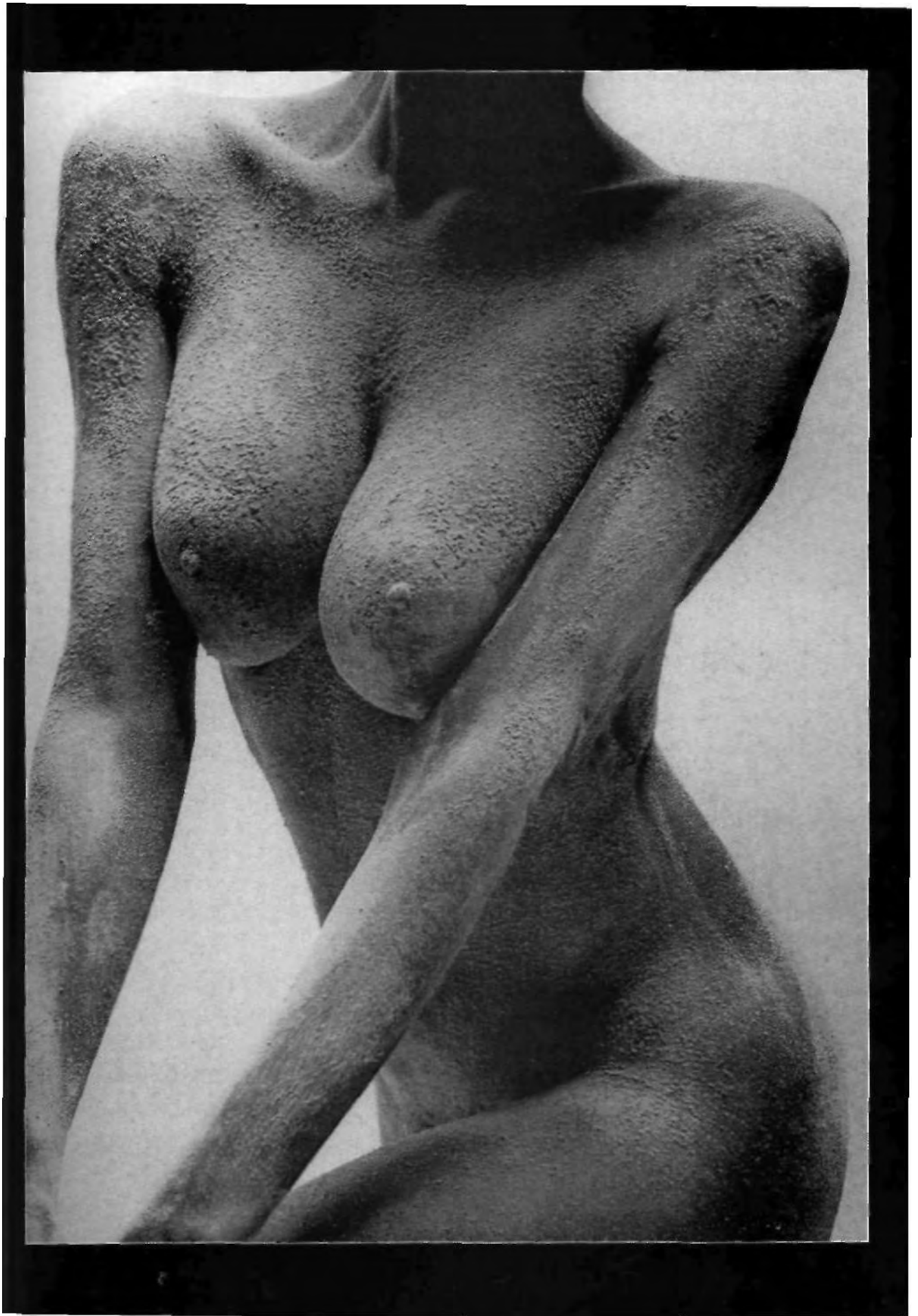

# ACHILLES

photographer **Patrick Coughlin**

**use** personal work  
**model** John Palmer  
**assistant** Nick Austin  
**art director** Steve Foster  
**camera** RB67  
**lens** 50mm wide angle  
**film** Kodak EPP 100 ISO  
**exposure** f/11  
**lighting** electronic flash  
**props and background** painted background of various rectangular shapes

Achilles is of course best remembered for his **proverbial heel**, the one vulnerable part of his body, according to Greek mythology. The subject matter here recalls the ancient story, with the all-important heel firmly in the foreground.

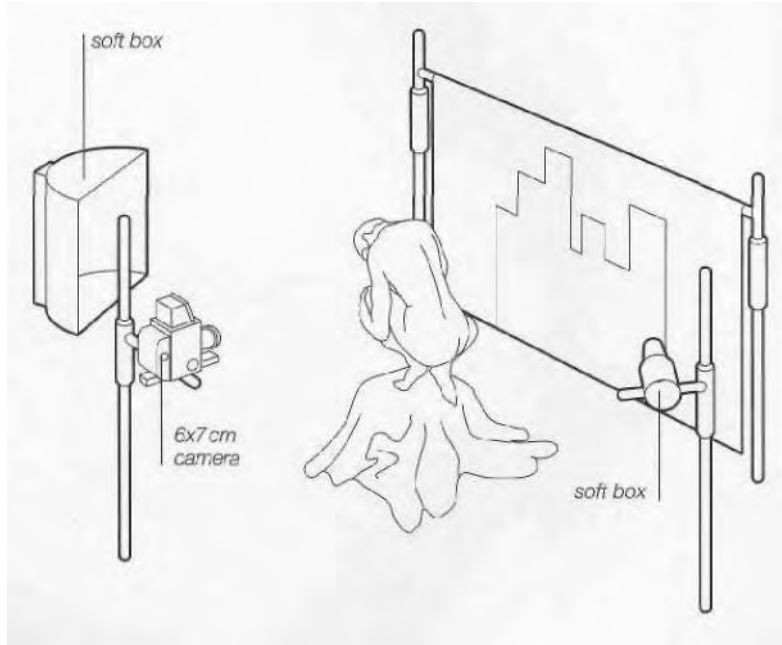
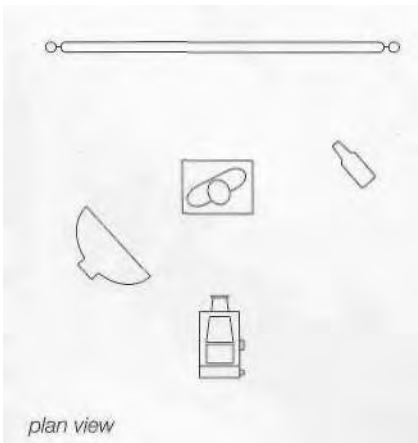

## key points

*The wide-angle lens is used to give a distorted effect to the body, and this necessitates the use of a very large backdrop - some 20 feet high, in fact, here*

*Lighting effects can be incorporated into the design of a backdrop*

The styling follows the theme of classical hero, with the sculptural pose, the magnificent physique of the model, and the golden colouring (created by the use of warm-up filters on both lights and lens) giving the impression of a gilded statue. The high-key areas on the near side of the body are achieved by placing the soft box close to the model.

The background has rectangular shapes painted on it, giving the impression of three-dimensional blocks. The positioning of the light on the model is essential for this illusion, so that actual highlights and lowlights in the foreground accord with the apparent ones painted on the background.

## photographer's comment:

*Achilles has been slightly distorted on image manipulator to emphasise the style of Tamara-de-Lempicka.*

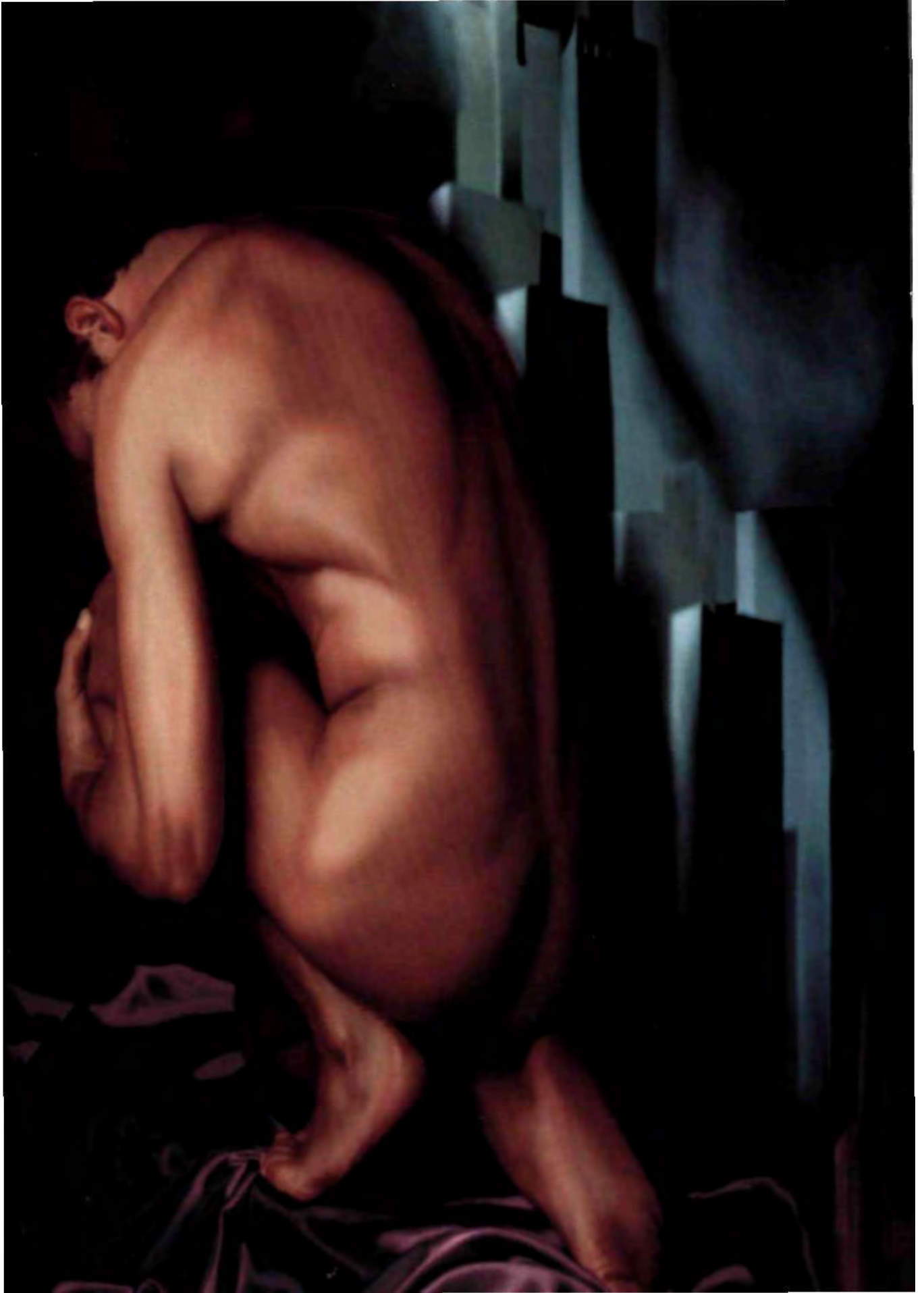



# DRAPED NUDE

photographer **Gerard de Saint-Maxent**

**use** editorial  
**camera** Mamiya 645  
**lens** 105mm  
**film** Tmax 400  
**exposure** 1 /30 second at f/5.6  
**lighting** available light

**It is amazing what a stunning but simple effect can be achieved with just a model, a drape and available light in conjunction with the right film stock.**



*plan view*

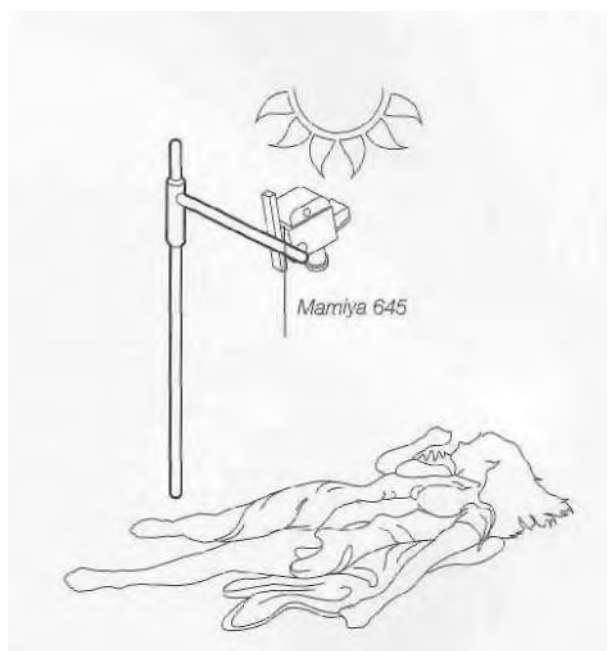

## **key points**

*Tight lighting ratios are required for higher contrast films*

*Lighting from above with rapid fall-off can give an interesting effect*

The fine silvery look of this shot is typical of Gerard de Saint-Maxent's work, as is the delicate composition, tending to the abstract body study. This is simplicity at its most effective.

Notice the careful positioning of the model to allow the play of sunlight to fall quite remarkably distinctly on each breast, giving a different look and effect in each case. The far breast is very high-key and deliberately slightly bleached out, while the nearer breast is

away from the light source in much deeper shade. The arrangement of the drape is also important. In places it clings to the undulating landscape of the torso and emphasises every rise and fall of the body; elsewhere it is positioned in apparently careless ruffles, which are actually carefully contrived in order to catch the play of light. It thus adds to the textural interest as it plays against the smooth sleekness of the model's body.



# BLUE WALL

photographer **Craig Scoffone**

**use** personal work  
**camera** 35mm  
**lens** 45-125mm  
**film** Fuji Provia 100  
**exposure** not recorded  
**lighting** electronic flash  
**props and background** textured white wall

A single electronic flash was suspended above the subject who was posed against a white wall, providing a cool shower of light. >

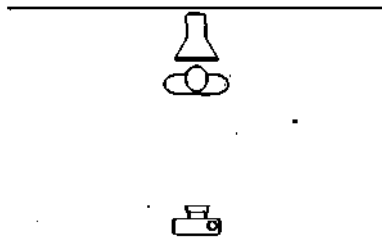

plan view

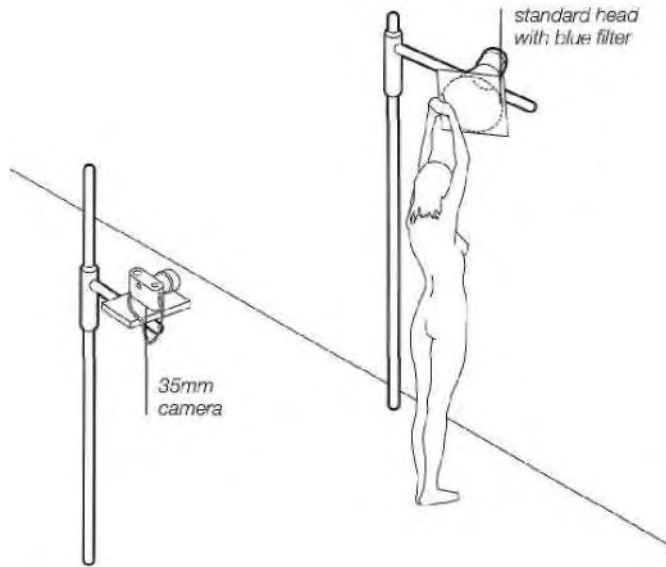

## key points

*It is a considered decision whether to place a gel over a light or a filter over the lens*

*Even the most familiar subject can be given an abstract form*

The cascade of light down the wall turns the backdrop into a pane of indirect back light. In front of it the model stands out in silhouette against the sharply defined triangle of light, bounded by the shadows that her arm creates. The small amount of stray light that falls on the model gives a rim-light definition to the hair details and extremes of the hips and body.

The colour comes from a blue gel over the standard head. This works well with the textured white wall as the movement of the wall surface results in different shades of blue due to a drop in colour temperature in the shadow areas.

Most important to the composition is the tiny, neat triangle of light between the thighs - this small detail provides a hugely erotic surge.

## photographer's comment:

*Good lighting is like cooking: you add only when there is good reason to add. In this photo a single light source says more than any other number of lights could ever say.*





ACCESSORIES and  
**10** PROPS



Accessories and props can be used to emphasise and enhance particular features of the erotic shot model, and they can also inspire a whole look or composition on the part of the photographer. While accessories can draw attention to features of the model, often in startling ways (for example, Salvio Parisi's "Unhard rock!"), props can impose a physical framework on the set, within which the photographer must work. Both model and photographer respond and react to the chosen accessories and props, as in Maurizio Polverelli's "Dressing room", for instance. Taking the time for open-minded experimentation with a variety of items can be an exciting undertaking and can stimulate the imagination immensely and lead to a creative and unexpected outcome for both photographer and model - and, of course, for the viewer.



# DRESSING ROOM

photographer **Maurizio Polverelli**

<b>use</b>	portfolio
<b>model</b>	Birute
<b>assistant</b>	Emanuele Mazzotti
<b>make-up</b>	Giovanni (Ide a 2)
<b>camera</b>	35mm
<b>lens</b>	50mm
<b>film</b>	EPR 64 ISO
<b>exposure</b>	not recorded
<b>lighting</b>	electronic flash
<b>other</b>	elaborated with Photoshop

**The choice of the metal mesh chair in this shot demonstrates how a furniture prop can be used to inspire both model and photographer.**

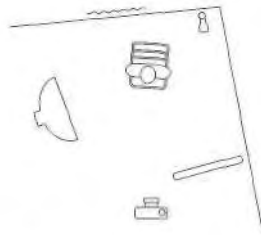

plan view

## key points

*A soft box used in close proximity can still give a harsh quality and cast strong shadows*

*Lamps can be used as props as well as light sources*

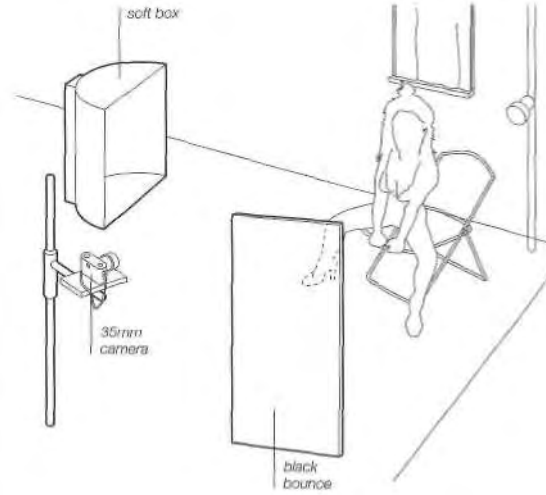

The model here uses it almost as an extension of herself, while from a composition point of view it provides interesting form and texture.

The soft box is close to the model, on her left. On the right of the model is a black bounce, to increase the fall-off on that side. The small lamp visible in the shot is more of a prop than a core lighting element, but nevertheless has

some impact on the model's hair, giving a reddish patch of light due to the very low colour temperature of a domestic bulb.

Notice how the shadow cast by the arm across the leg gives the impression of a stocking top, adding to the eroticism and increasing the ambiguity about what the model is wearing - the allure of uncertainties is well known.

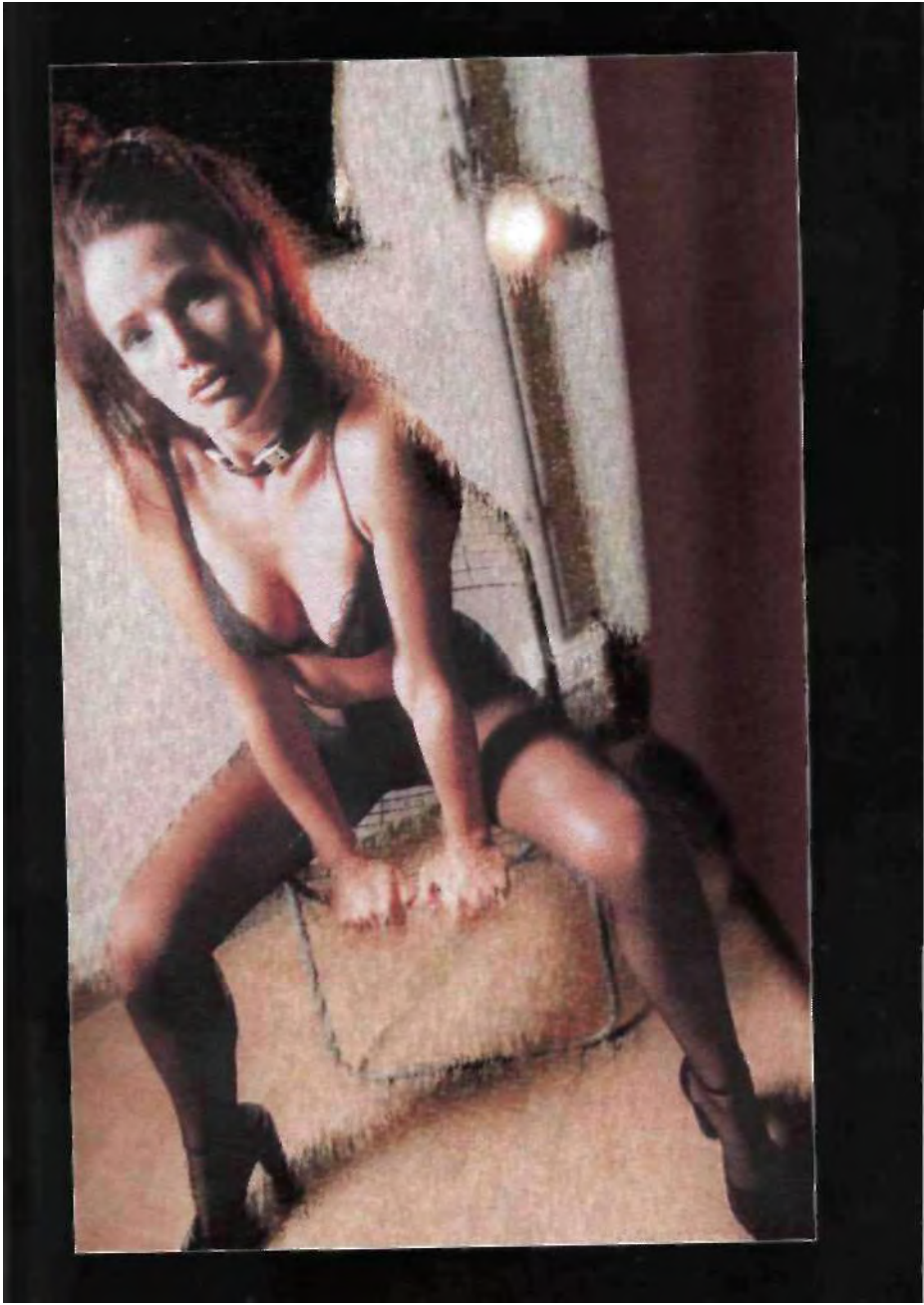



# EROTIKA

photographers **Ben Lagunas and Alex Kuri**

The eroticism of this shot stems largely from the voyeuristic feel created by the pose and props.

**client** Private art  
**use** gallery  
**model** Viridiana  
**assistant** Christian Taylor, Paulina, Janice  
**art director** Ben Lagunas  
**stylist** Vincent St Angelo  
**camera** 35mm  
**lens** 180mm  
**film** Kodak Tmax  
**exposure** 1/60 second at f/11  
**lighting** electronic flash

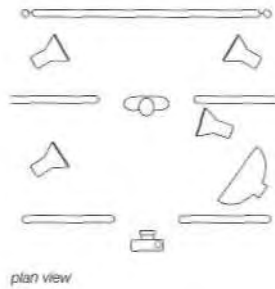

## key points

*Tungsten light is better for lighting models, but when working with so many sources the heat can be far too intense and flash heads are therefore the obvious choice*

*It can be very important to light a background separately from the subject matter*

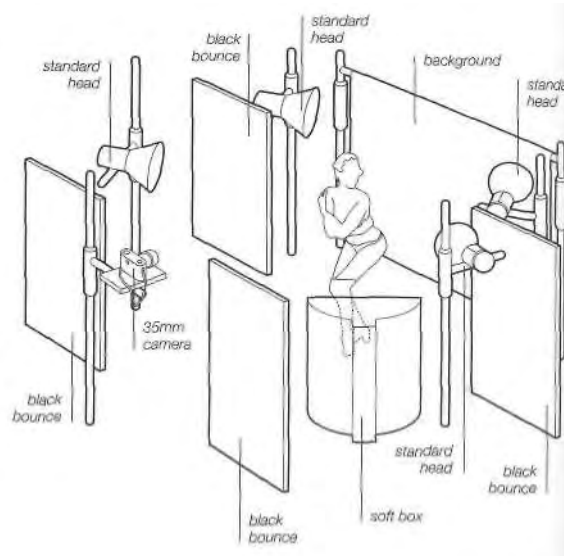

The self-protective position the model has adopted combines with the state of almost complete undress to give an air of vulnerability and the impression of a person caught unawares.

The boots and sunglasses only add to the sense of nakedness and exposure, and the anonymity that the sunglasses provide is another important element in the allure of the shot. The background is lit evenly by two standard heads and any

spill from these lights is flagged off the model by two black panels. The key light is to the left, with a back light opposite this and fill light positioned to the right; basically, a classic three-point lighting set-up, superbly executed.

The two black panels in front of the model create shade at the front of the body, which the model crouches into, and seems to clutch to herself as if for cover.



# THE PROPOSAL

photographers Ben Lagunas and Alex Kuri

**client** Private art gallery  
**use** gallery  
**assistant** Isak, Christian, Paulina, Janice  
**art director** Ben Lagunas  
**stylist** Vincent St Angelo  
**camera** 6x6cm  
**lens** 350mm  
**film** Kodak Tmax  
**exposure** 1/125 at f/11  
**lighting** electronic flash

**Just a single focusing spot gives the dramatic look to this shot.**

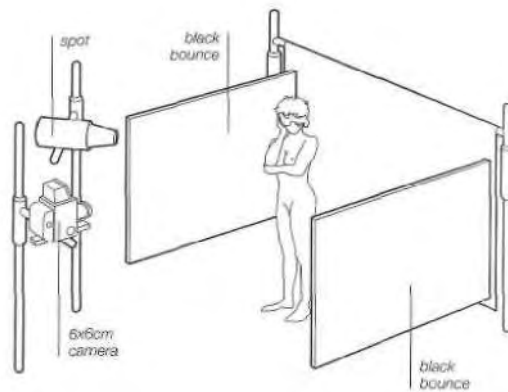

## key points

*Props can be used not only in their own right, but also to provide interest and variation to the lighting*

*Black panels can dramatically reduce the fall-off within an image*

The shadows of the arm are strong and clearly defined, the features of the face are clearly delineated with the shadow under the chin giving definite modelling, and the shadow of the model against the backdrop breaks it into two distinct zones of light and dark. The black panels enhance the fall-off to the sides, adding to the clear-cut modelling and crispness of the final image.

The mask is an arresting prop in itself and works well to emphasise the "proposal" of the title that clearly emanates from the eyes (further emphasised by a catch light). The position of the model's arms is all-important/ concealing one breast and framing the other, and thus drawing attention to the exposed nipple, which seems to stare at the viewer just as directly as the eyes do!



# MARIA

photographer Ricardo de Vicq de Cumplich

<b>use</b>	exhibition
<b>model</b>	M a r i a A d e l i a
<b>assistant</b>	Ednaldo de Sousa Ramos
<b>hair and make-ups</b>	Joaozinho
<b>stylist</b>	Debby Gram
<b>camera</b>	4x5 inch
<b>lens</b>	210mm
<b>film</b>	Kodak Tmax 100
<b>exposure</b>	f/22
<b>lighting</b>	electronic flash and light brush

The four discrete layers of background imagery which in turn give three strong horizontal lines are visually powerful within themselves, but open to interpretation by the viewer.

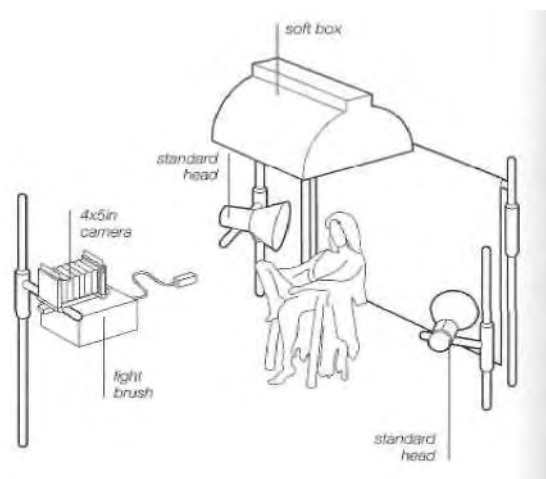
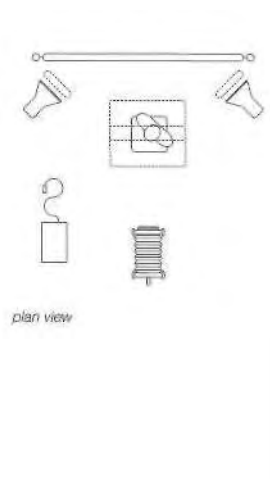

## key points

*The larger the negative, the more we are able to see into the shadows*

*This shot is not lit "naturalistically" but for effect, which is an equally valid option depending on the end result required*

This gives a sense of mystery to the setting, matched by the gleaming, ethereal quality of this image, which stems from the use of two different types of lighting. The initial exposure is from a large overhead soft box above the model and two standard heads angled either side of the backdrop and modified by diffusers. The shutter stays open for further exposure in the form of a light brush.

Here the photographer has applied the light brush to the hair, breasts and

knee, to the scarf draped on the chair and an area on the floor in front of the model, and also to the side of the model's face. This highlighting of both the hair and the face is somewhat unnatural in appearance, but creates interest in the image.

The position of the high-key head is important, being placed against the dark strip of the background for separation. Equally important is the draping of the scarf, which echoes the shape of the hair.



# STILETTOS

photographer **Corrado Dalco**

client The Saddler SNC  
use editorial  
model Adriana Giotta (Elite Milan)  
assistant Alberto Artesani  
**art director** Corrado Dalco  
stylist Manuela Vignali  
hair Jonathan  
**camera** Polaroid 636CL  
lens 38mm  
film Polaroid 600 BAN  
exposure 1/15 second at f/11  
lighting electronic flash

**This image by Corrado Dalco demonstrates a very modern approach to composition and lighting. However the more traditional considerations of form, line, tone and texture are still the underlying and key ingredients to make the image work.**

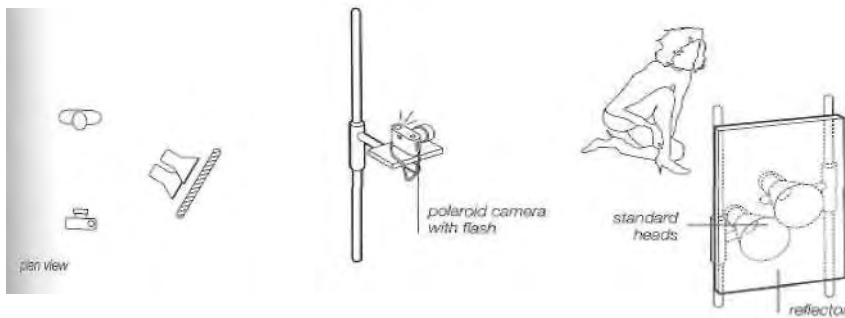

## key points

*it is important to be aware of spatial relationships within a scene and to utilise the positioning of objects to provide shape*

*A wide-angle lens can offer an added dimension to a shot but can be prone to flare*

The costume chosen is very simple with enough movement and interest to appeal to the eye. The choice of stiletto heels is a somewhat more standard fetish, but this is underplayed by the tight cropping. The actual physical setting is also of major importance, the recessed corner providing the potential for shadow, which in turn emphasises the long legs, which are also exaggerated by the wide-angle lens.

There is enough contrast to the image to obviate the necessity for generally hard lighting.

Two standard heads bounce off a white reflector panel to the right of the camera and an on-camera flash provides another blanket of light; just the right lighting to complement, but not over-exaggerate the graphic quality of the picture.





# UNHARD ROCK!

photographer **Salvio Parisi**

**The imaginative styling of relatively innocuous props gives this shot its powerful impact.**

**client** Trend magazine  
**use** editorial  
**model** Stefania A'Patz  
**assistant** Chicca Fusco  
**art director** Salvio and Massi  
**make-up and hair** Clemente Oliva  
**stylist** Giotto  
**camera** Canon EOS 1N  
35mm  
**lens** 135mm/f/2.8  
**film** Kodak Ektachrome  
100 Plus  
**exposure** 1 /125 second at f/8  
**lighting** electronic flash  
**props and background** white paper background

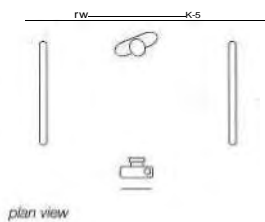

## key points

*A honeycomb can be used to create a "directional soft light"*

*Different manufacturers' film stocks render colours with different hues. It is worth experimenting with numerous stocks to establish your preference*

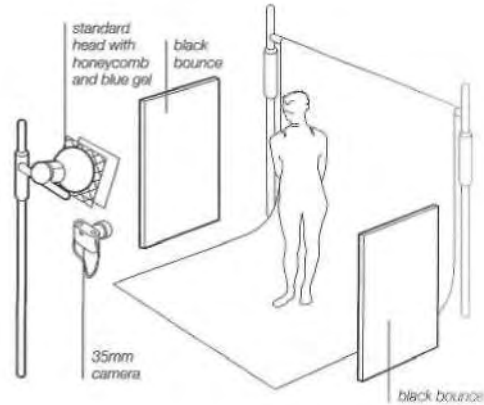

"This belongs to a series for a magazine editorial on fashion accessories, with a sexy and ironical mood," explains photographer Salvio Parisi. "That's why it's got a cold light blue dominant and the accessories are worn in an improper way (the model has a metal tie knot in her mouth and a garter belt as a mask!)." The fierce model pose, cool lighting and provocative use of the accessories combine to produce a strong, "in your face" erotic image with a humorous twist. The set-up for this shot is virtually identical to that

used for Ben Lagunas and Alex Kuri's "Amore" shot, in terms of the positioning of the source light, reflectors and model. The difference lies in the relative hardness and softness of the sources. Whereas Ben Lagunas and Alex Kuri chose a hard key, producing deep black shadows, Salvio Parisi has modified the standard head with a honeycomb and a blue gel to soften and cool the look. This arrangement produces a less deep, translucent shadow behind the model.



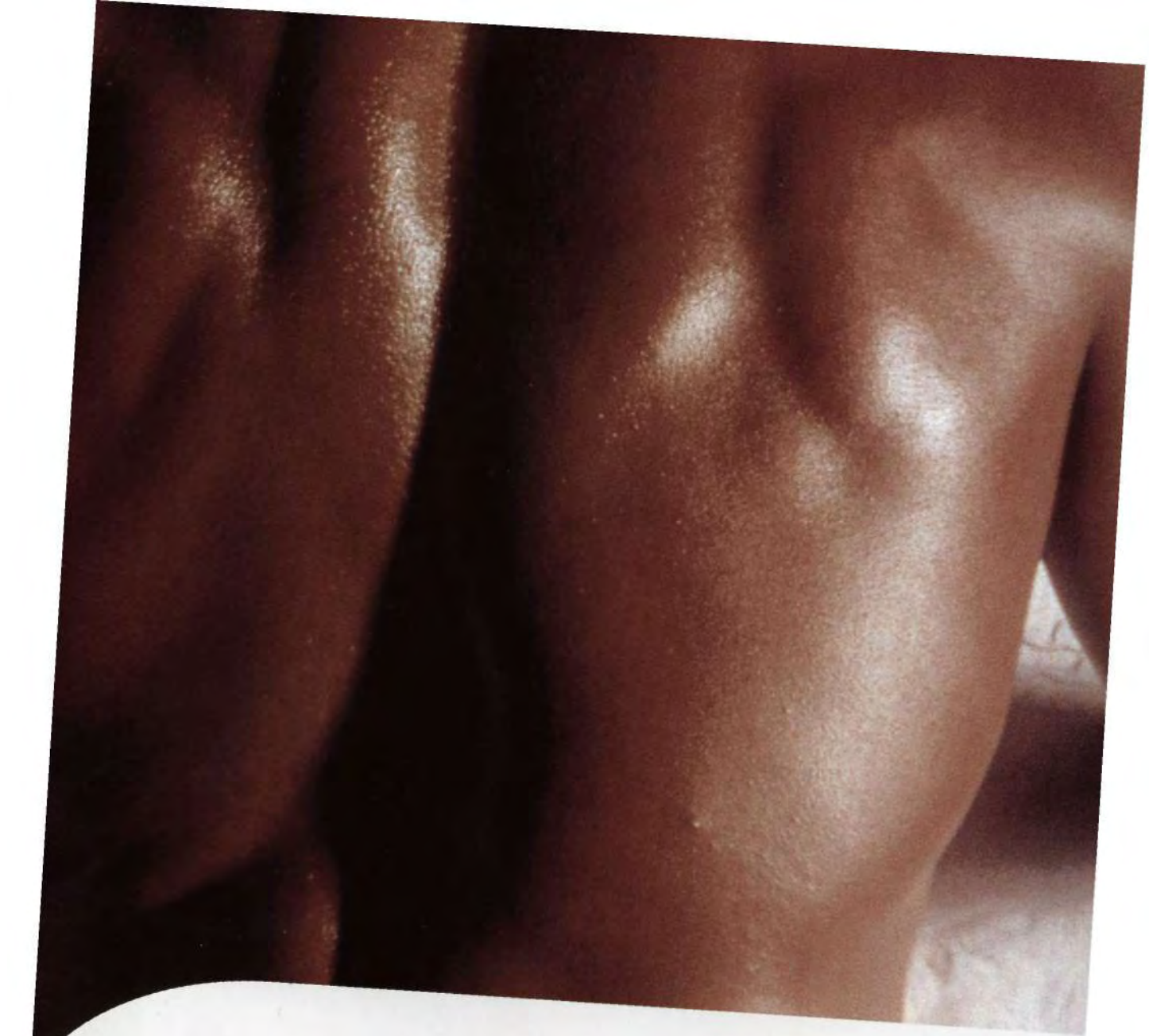

TEXTURES,  
PATTERNS and  
FORMS

11



**TEXTURES.**



**PATTERNS and  
FORMS**

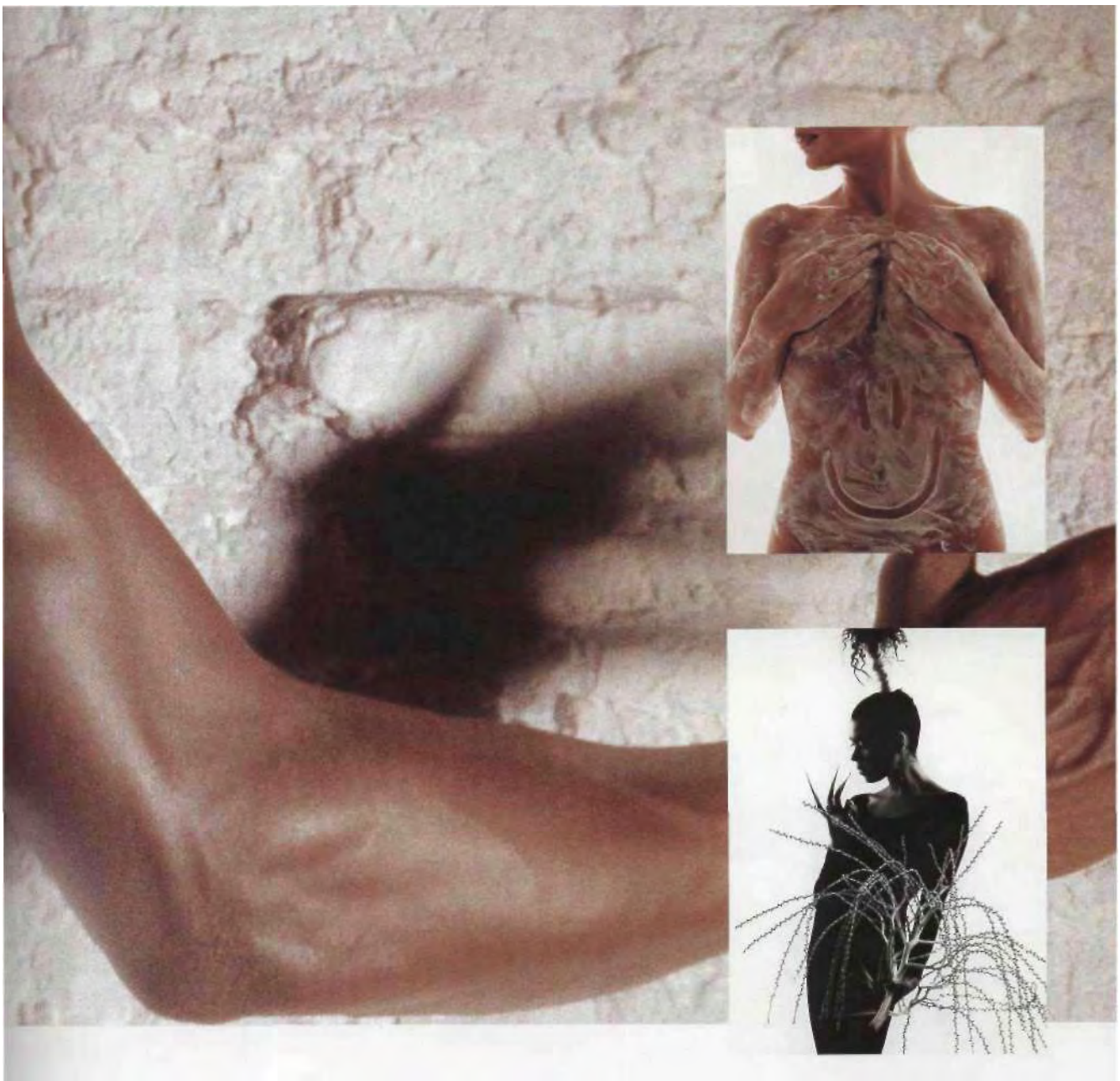

Textures, patterns and forms make a strong impression on the eye and they can come into their own as a major factor in the impact of a shot. Textures and patterning motifs might be part of the background, part of the foreground, a feature of the costume or model styling, or, of course, an aspect of the lighting. Successful composition and model-posing rely hugely on an appreciation of form, and on a thorough understanding of lighting.

Textures and forms can have a quite different impact when shot in colour or black-and-white. Colour can detract from the graphic idea that is being conveyed, while monochrome can emphasise the tones that are an inherent constituent part of the textures. The preponderance of black-and-white shots in this chapter is not just coincidence!



# WOMAN WITH BACK ON PUMPKIN

photographer **Benny de Grove**

<b>client</b>	Flanders Expo
<b>use</b>	exhibition
<b>model</b>	Filip
<b>assistant</b>	Ann Temmmenman
<b>art director</b>	Anja Forceville
<b>camera</b>	6x6cm
<b>lens</b>	150mm
<b>film</b>	Kodak Tmax 100 ISO
<b>exposure</b>	not recorded
<b>lighting</b>	electronic flash

"The standard head had to be the strongest source because I only wanted a silhouette rather than the whole figure," says photographer Benny de Grove.

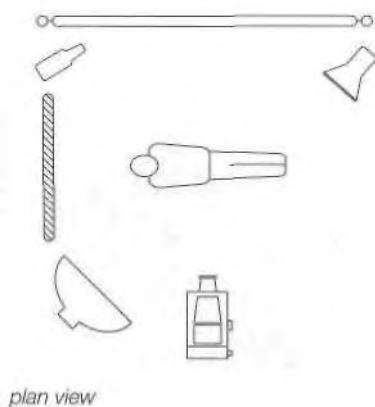

plan view

## key points

Notice how a key light can also act as a back light and be effectively dual purpose

Picking up on thematic elements and motifs (such as textures, subject matter, lighting patterns) can make for a strong composition

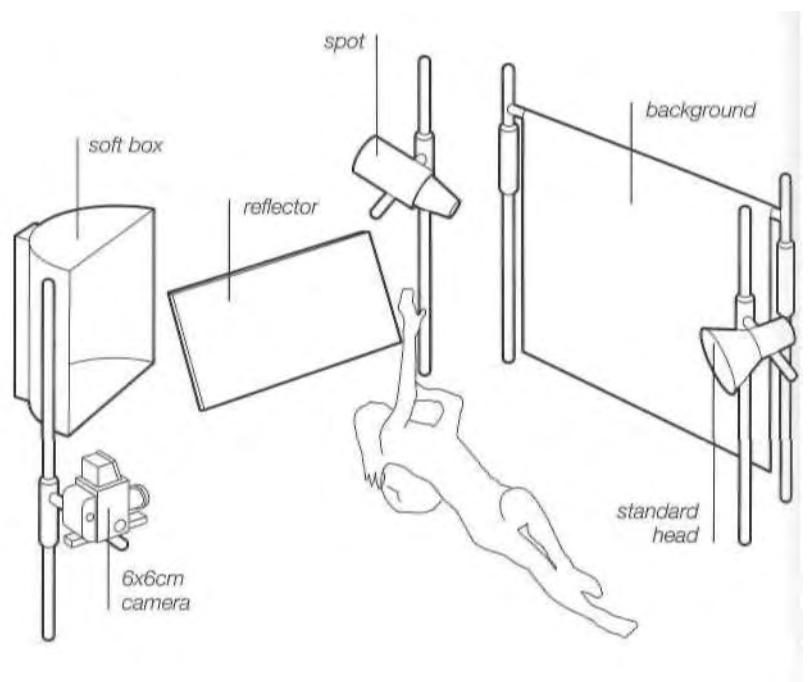

Benny achieves this very successfully using three flash heads and one white reflector panel. Overall this is a low-key image but with areas of high key, which gives high contrast and a creative "take" on traditional silhouette. A standard head is placed behind the model to the right. Diagonally opposite this is a one-metre square soft box providing fill light and highlighting certain areas of the model. The white reflector bounces light from the key at the back onto the foreground areas of

the subject. The third head is a focusing spot aimed at the background, providing a pool of light behind the model. To add interest to the composition the background is painted with similar textures to the pumpkin over which the model is arching. Notice how the positioning of the key head (back and high) allows light to skim over the model and the pumpkin, just defining both the bones of the model's rib cage and the ridges of the pumpkin flesh, to emphasise their textural similarities.

## photographer's comment

*The picture was developed with a brush.*

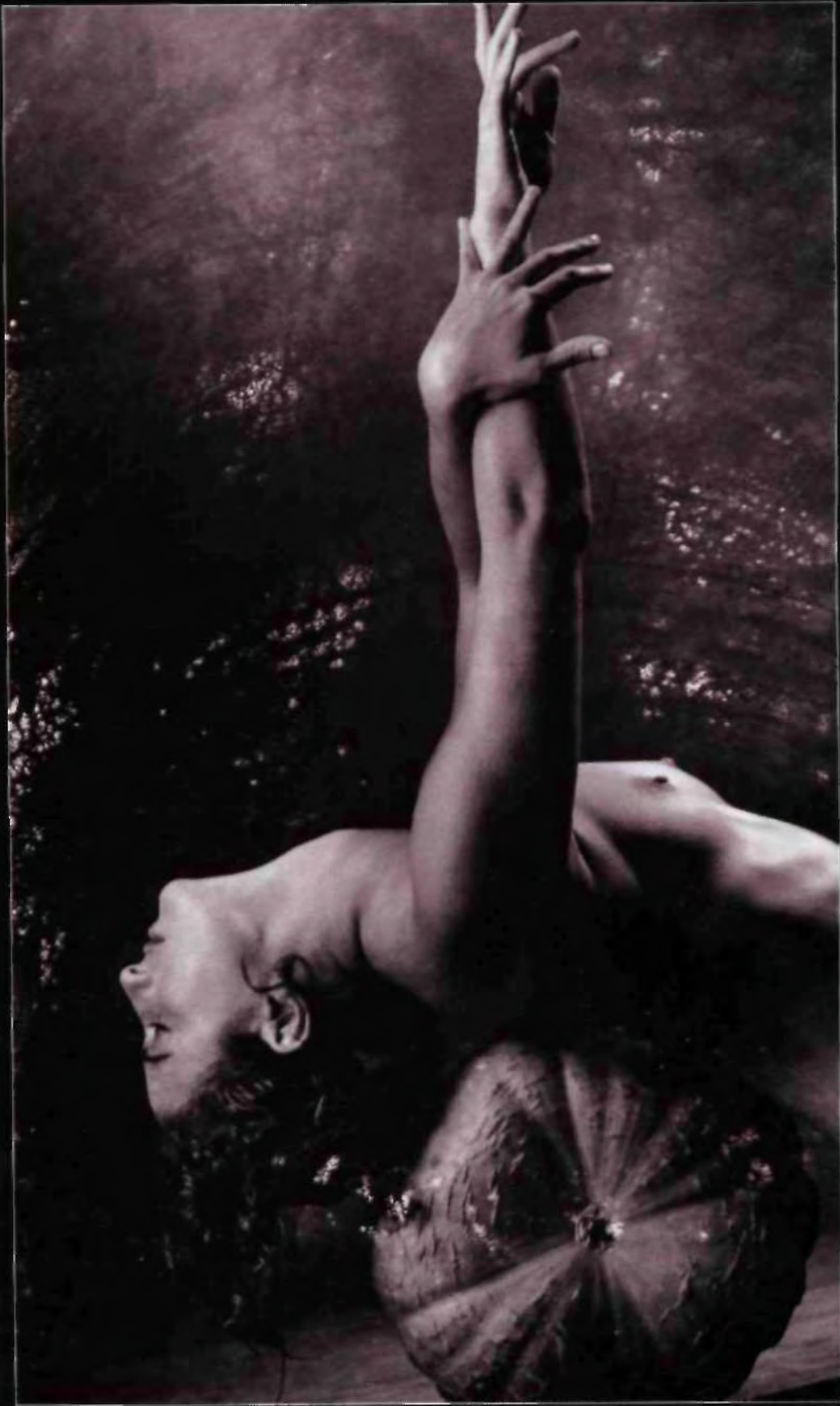

# PALM

photographer **Nopphadol Viwatkamolwat**

**client** Hasselblad (USA)  
**use** showcase advertising  
**model** Alia McKeon  
**art director** Nopphadol Viwatkamolwat  
**stylist** Jody Demarcos  
**camera** 6x6cm  
**lens** 80mm  
**film** Kodak Tmax 100  
**exposure** 1/125 second at f/8  
**lighting** electronic flash  
**props and background** black nightgown. Palm branch, Thai dancing nails, seamless background

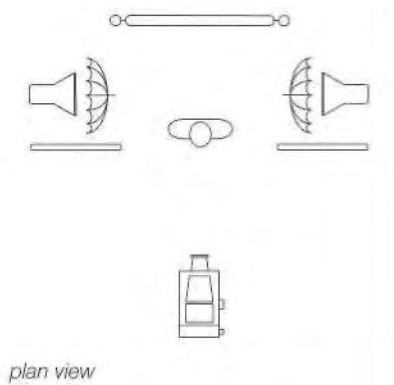

Compare this shot with Benny de Grove's "Woman with back on pumpkin" as another slant on the use of the silhouette and the compositional technique of using textural motif effectively.

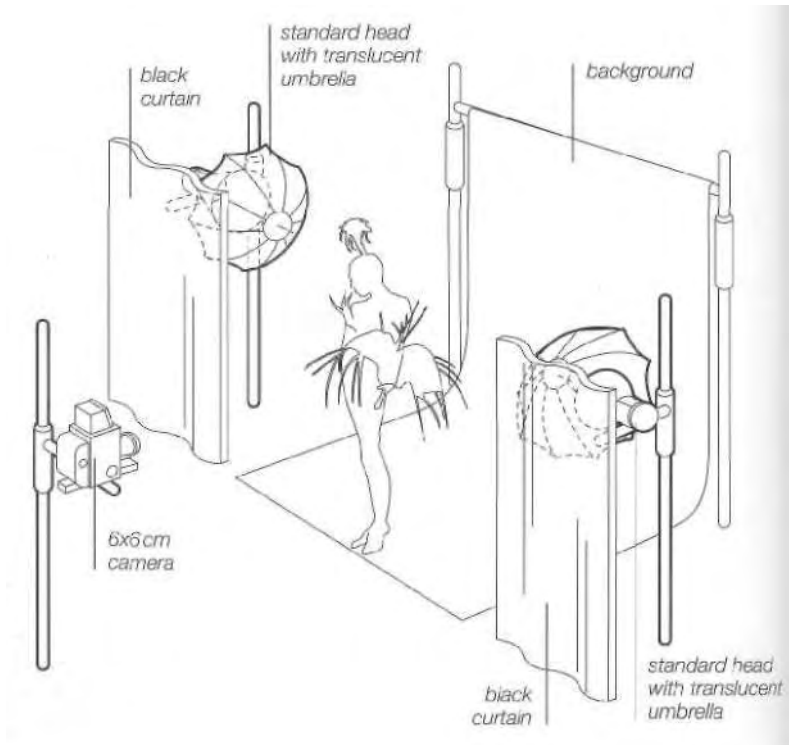

## key points

*Compositionally, the palm branch, fingernails and hairpiece are carefully selected for their interrelationships and textural qualities*

*There are degrees of black, but virtually nothing will reflect off an absolutely matt black surface*

Whereas Benny de Grove uses a low-key image with areas of highlight on the model, Nopphadol Viwatkamolwat has created a high-key image with a very low-key main subject, which, overall, makes for high contrast. There is no front light for this dramatic shot. The model stands against a white seamless background between two black curtains, which shield her from most of the spill light from symmetrically placed standard heads with translucent umbrellas. Just enough spill is allowed

to fall on the forehead, nape of the neck and hairpiece to lift these areas. The palm branch and fingernails are also lit by the carefully judged spill. The choice of dark-skinned and dark-haired model, in a matt black costume, means that without any front light she will be in silhouette, no matter how much spill light there is. The palm branch and all-important fetishistic false fingernails, by contrast, sing out against the dark background of the model.

## photographer's comment

*A dramatic look can happen from a simple technique but it has a unique style.*



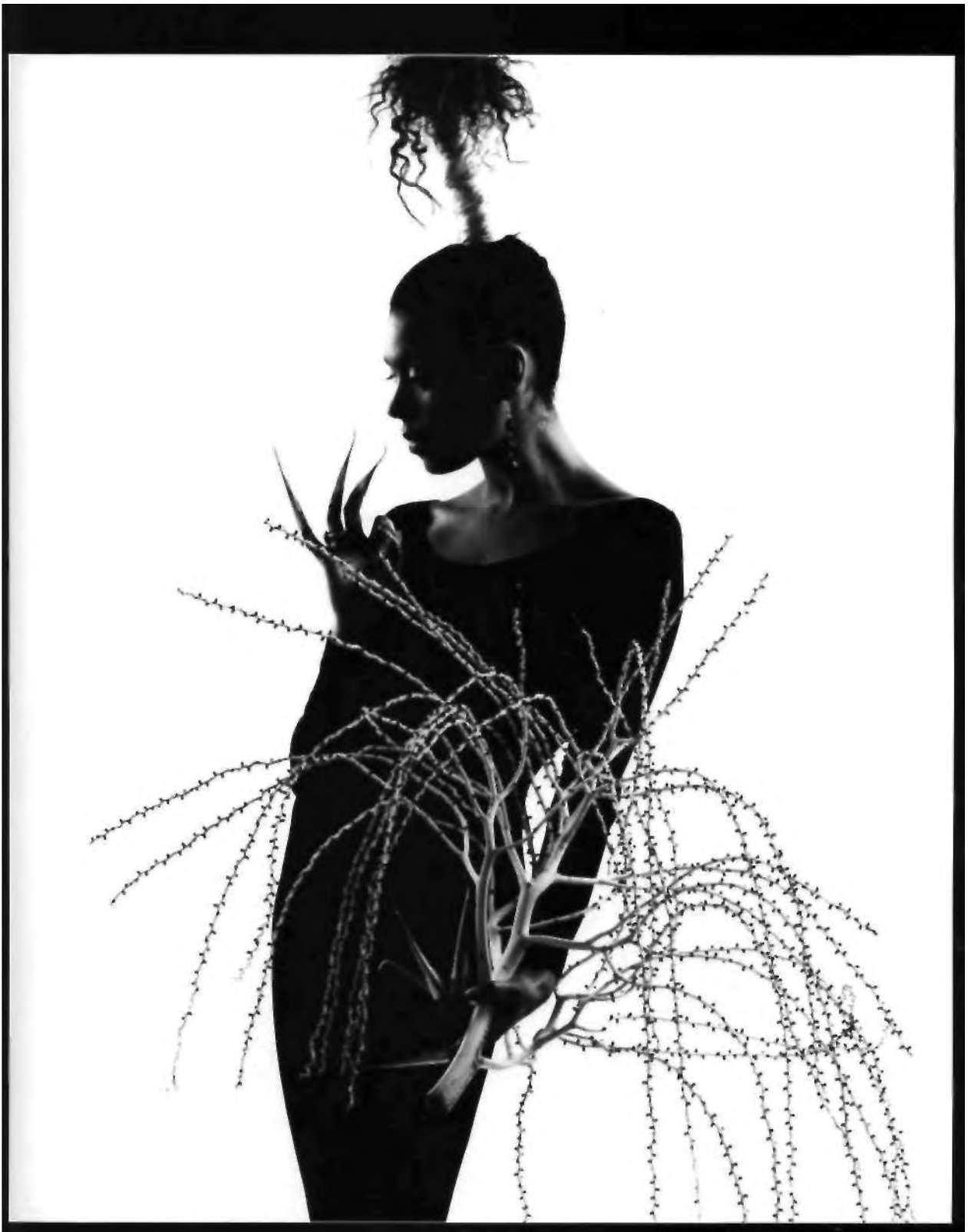

# AMORE

photographers Ben Lagunas and Alex Kuri

**client** Private art  
**use** gallery  
**assistants** Isak, Christian, Paulina,  
Janice  
**art director** Ben Lagunas  
**stylist** Fabian Montana  
**camera** 6x6cm  
**lens** 350mm  
**film** Kodak Tmax  
**exposure** 1 /125 second at f/16  
**lighting** electronic flash

This is a simple, effective image with a simple lighting set-up.



## key points

*A carefully chosen single source (used with reflectors and background) is often all that is required*

*A hard direct source is very versatile: it can be modified to become a soft source, whereas a soft source cannot be made hard so easily*

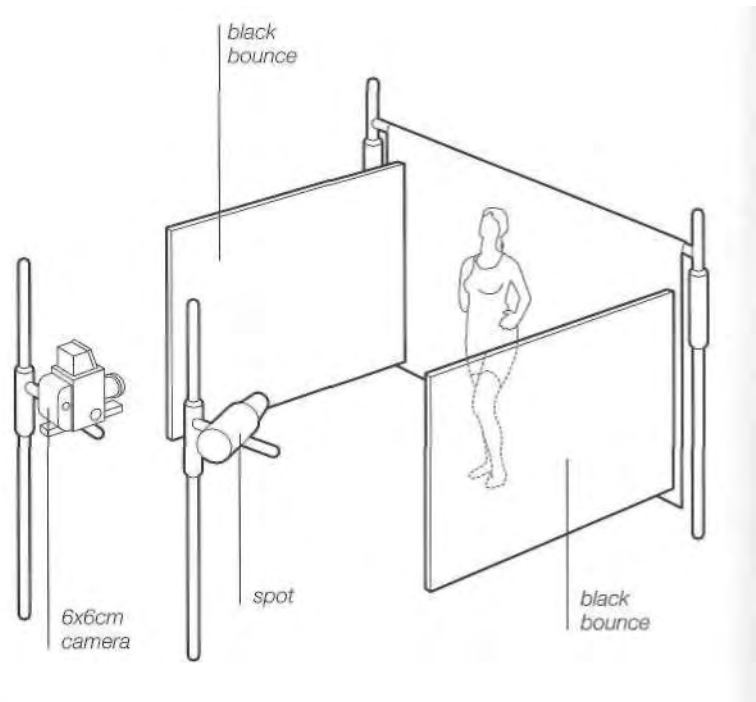

The model is placed with her back almost right up against a white background. A tunnel is made with two black panels, one either side of the model, and perpendicular to the background. The camera is square-on to the model and slightly to the right, and about a foot above of the camera is a focusing spot. This single source shines down the tunnel, illuminating the model and background. The very sharp shadow behind the model on the left of the shot is caused by the use of a focusing spot

and the model's proximity to the background, and this is a very dark black shadow.

The choice of a black fishnet costume is dramatic and gives a feeling of rippling movement within the still image - the nature of this kind of fabric is to "map" the surface it covers, and to provide a sense of the rise and fall of the body it part reveals, part conceals. The fishnet texture of the dress is echoed by the chain-mail hand jewellery.



# JACKIE

photographer **Jorgen Ahlstrom**

**client** LC  
**use** editorial  
**model** Jackie  
**camera** RZ67  
**lens** 90mm  
**film** Kodak GPH 100  
**exposure** not recorded  
**lighting** electronic flash

**The giant Pro-Bouncer soft box itself provides the dazzling white background for this shot.**

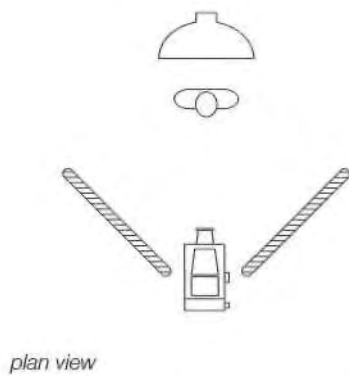

## key points

*Colour negative film has much more latitude than colour transparency stock*

*Flash light is much cooler than tungsten light in terms of actual temperature and so is probably better when working with substances that are liable to be changed by heat*

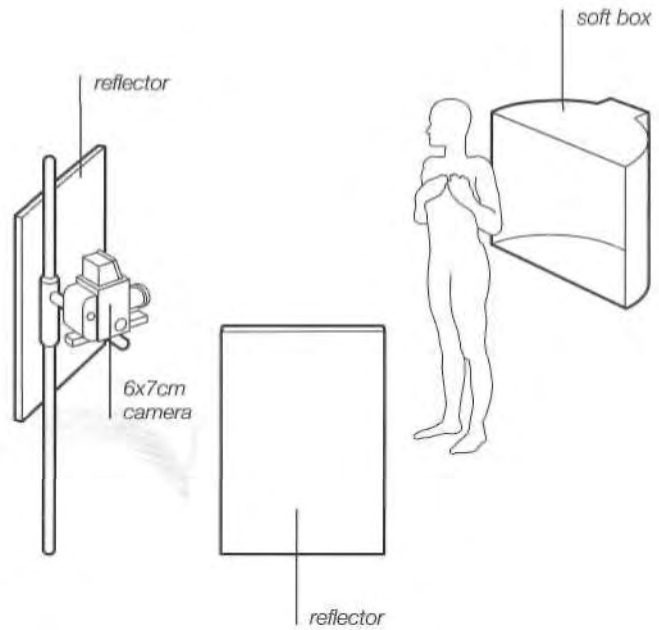

Around the edge of the model is what might be described as a glare light rather than a rim light: notice how the model's outline is edged with a silvery gleam emanating from the far side of her body.

The front of the body is lit by two large white reflectors. These are placed one on each side of the camera and bounce back light from the soft box to

give a symmetrical effect: look at the symmetry of the fall-off on both sides of the model's body. This arrangement also makes the most of the form of the soapy froth, catching highlights and lowlights on both sides of every part of the foam. It is not a naturalistic lighting set-up, but if the context does not call for realism there is no need to use a naturalistic arrangement.



# ANNIKA

photographer **Jorgen Ahlstrom**

**client** Sturebadet (SPA)  
**use** poster  
**model** Annika  
**camera** RZ67  
**lens** 105mm  
**film** Kodak PXP  
**exposure** not recorded  
**lighting** electronic flash

**Two standard heads shooting into umbrellas provide strong, bright and even illumination on the seamless white background.**

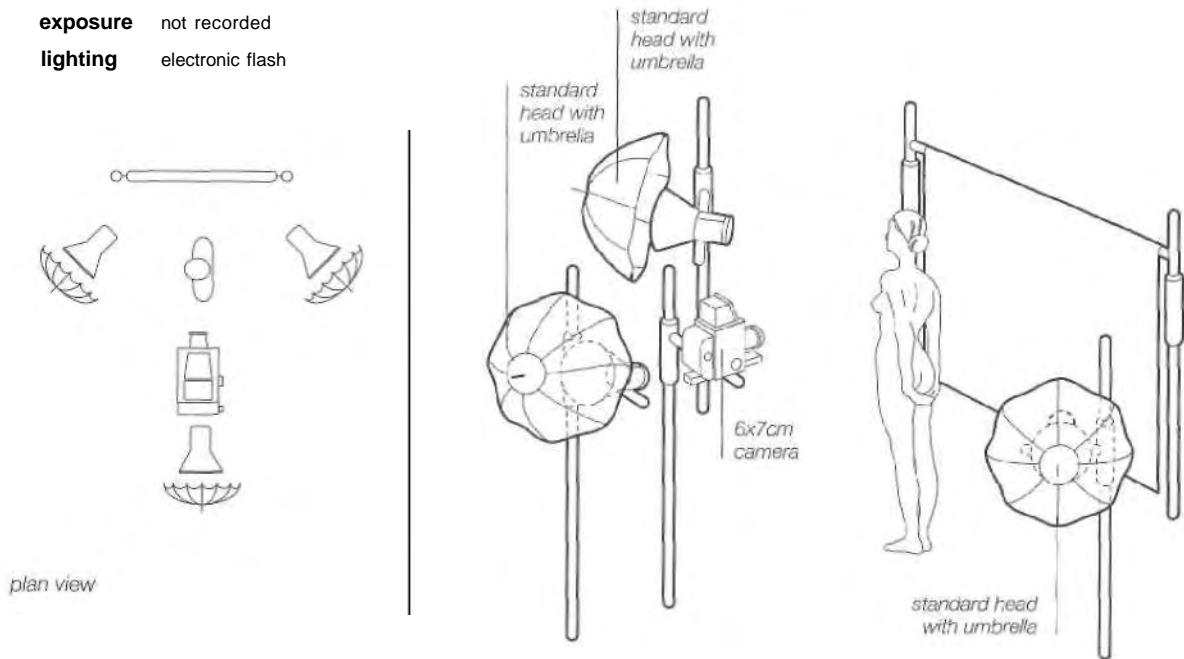

## key points

*The harmony of the pose is carefully conceived: the upturned features of the face chime perfectly with the natural upturn of the breast and nipple*

The model is lit by another standard head, again shooting into an umbrella and positioned immediately behind and above the camera. Separation is provided by the fact that the model is covered in mud-pack mud.

The application of the mud-pack changes the whole texture of the body and skin, and gives the surface a range of different crevices and ridges to catch the light. The shadows in the patterns of the mud give the body an almost • sculptural form, reminiscent of the bold

textures of a Rodin figure. The mud has been applied and patterned deliberately to emphasise the model's form. For example, the smooth sweeps across the breast provide a series of silvery lines defining its curvature as the light picks up the rippled texture of the mud.

The metallic thread hairnet is the perfect foil to the mud and skin textures, providing an area of intricate meshed design that reflects the light exactly at the position of highlight in the shot.

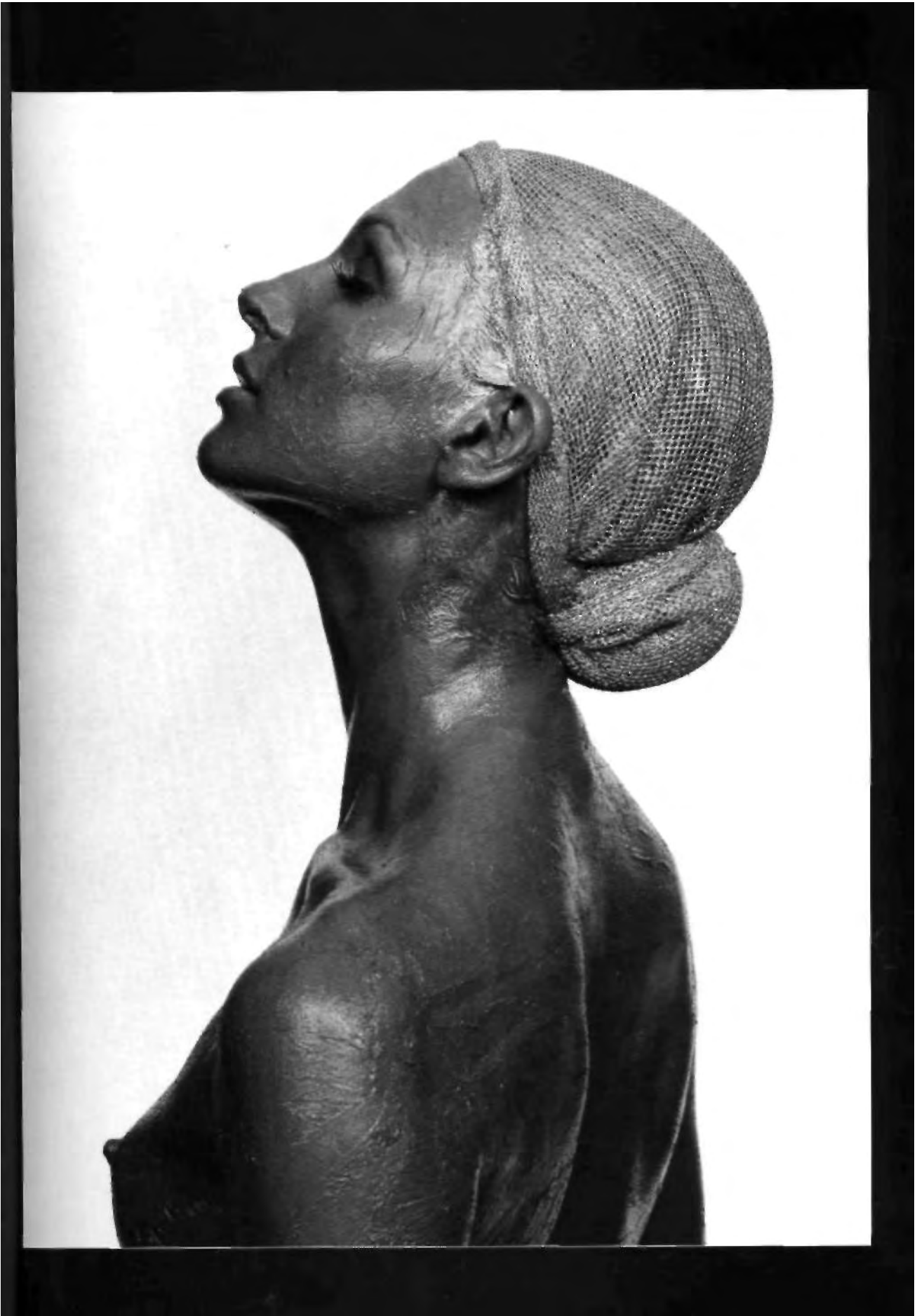

# WHITE TRELLIS

photographer **Bob Shell**

**use** stock  
**camera** 35mm  
**lens** 35mm  
**film** Kodak E100 SW  
**exposure** not recorded  
**lighting** electronic flash  
**props and background** garden trellis and black velour

The bold graphic form of the background trellis invites a spirited pose and interpretation from the model! and photographer.

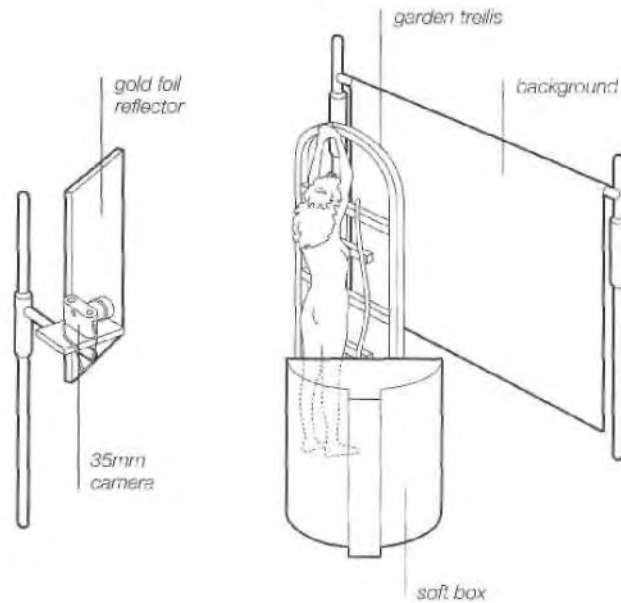
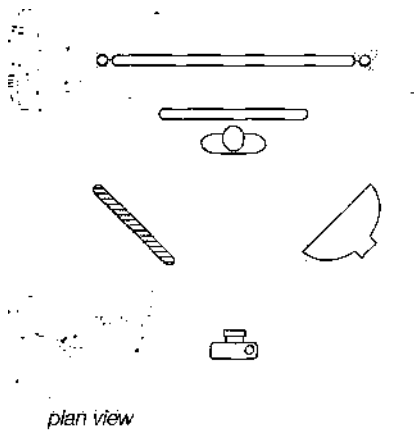

## key points

*Simple elements can combine to produce a far more complex image*

*Choice of film stock is very important if a warmer tone is required*

Here the model's nakedness seems doubly vulnerable in this position. The upstretched arms against the rigid framework of the trellis, in conjunction with the straddled leg position and black stiletto heels, combine to suggest classic bondage imagery without explicitly depicting anything so risqué. The subject is brightly lit by just a single large soft box to the right of the camera, bounced back from the left by

a gold reflector which adds warmth to the body and highlights to the Titian hair and hair slide. It is very important that the background should have no texture or movement in order not to detract from the starkness of the foreground composition and subject matter. The black velour is chosen for its well-known light-absorbing and non-reflective qualities.





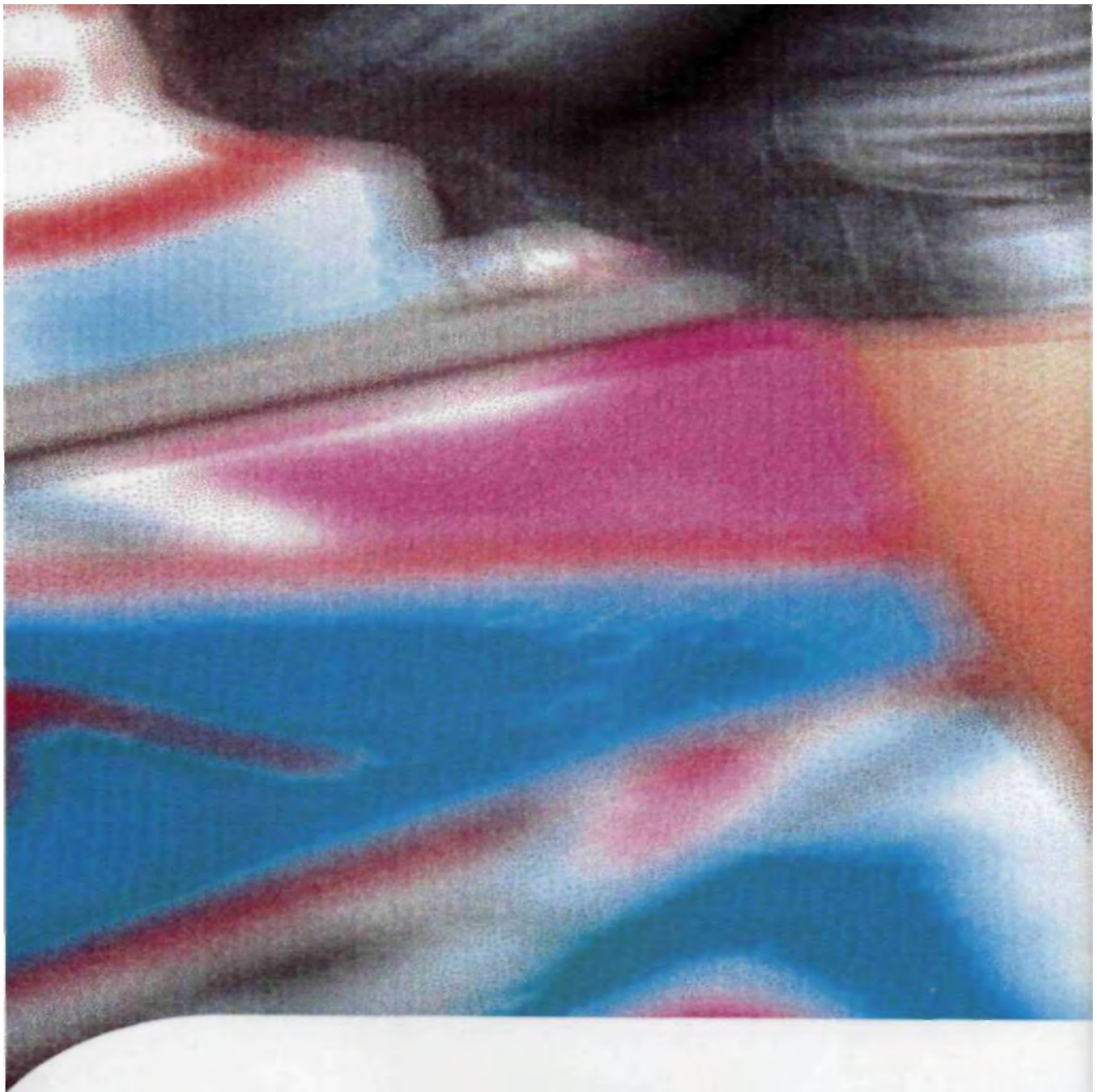

FETISH APPEAL

12

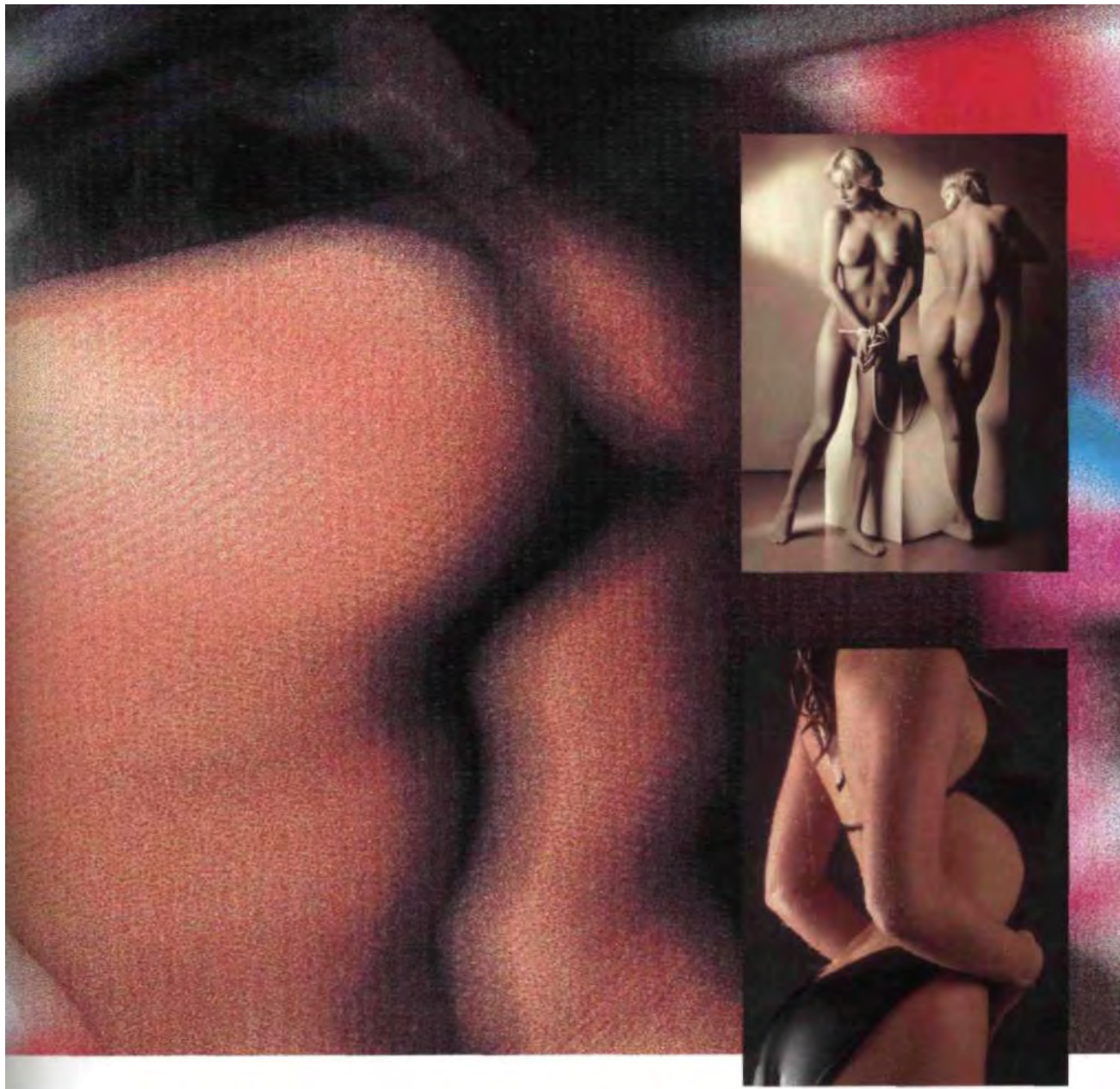

Fetish appeal is at once very narrow and very broad. For some, fetish appeal lies in an extremely precise set of details, so very specialised and particular to the individual's taste that it may be difficult for others to comprehend. This is the sense in which fetish appeal may be narrow. The other perspective is that almost anything might hold a secret fetish value for someone, somewhere, so in this sense it is a very broad kind of subject matter. Every individual responds differently to different things, and the possibilities of fetish appeal might seem to be endless. However, various common themes do seem to recur in erotic imagery. This chapter concentrates on some of the subjects that are widely regarded as having that indefinable fetish appeal.



# ANDROMEDA

photographer **Patrick Coughlan**

**use** fine art personal work  
**model** Vicky Lee  
**assistant** Nick Austin  
**stylist** Alchemy  
**camera** RB67  
**lens** 135mm  
**film** Kodak EPP 100  
**exposure** 1 /30 second at f/16 (flash)  
plus 1/4 second at f/16  
(tungsten)  
**lighting** flash: Strobex  
**props and background** Colorama  
grey with white plinth

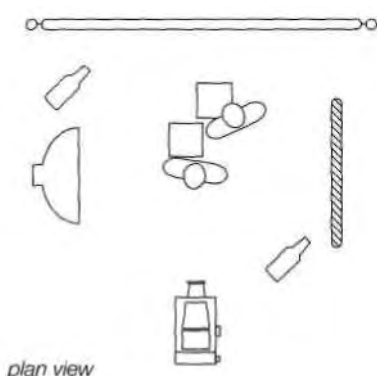

plan view

**According to Greek mythology, Andromeda's mother boasted that she and her daughter were more beautiful than Aphrodite, the goddess of love, and thus incurred the wrath of Poseidon, who sent a sea monster to ravage the lands.**

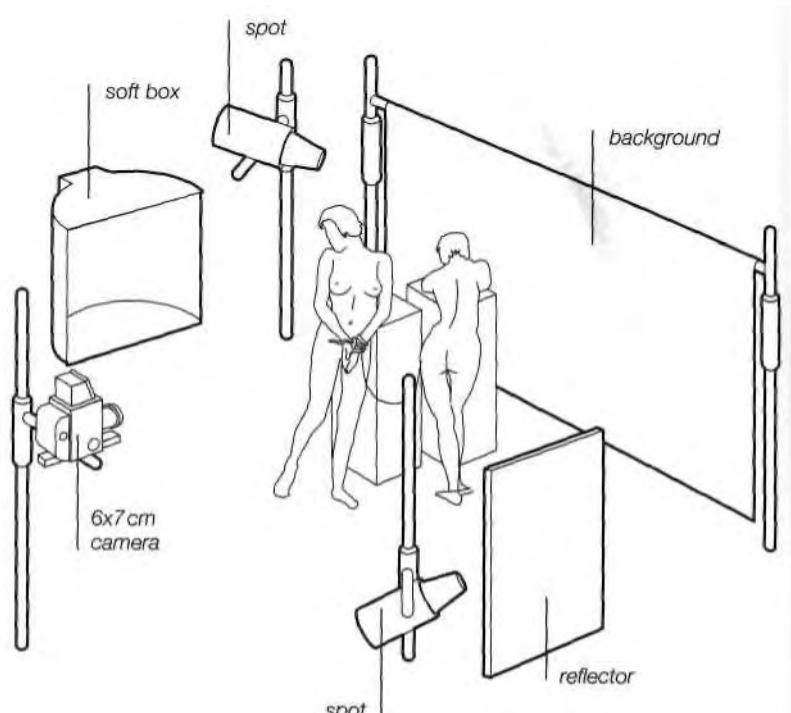

## key points

*Colour film shots can be duped onto black-and-white or sepia stocks later, if a different look is required*

*It is better to shoot an image "clean", i.e. without filtration or diffusion as these effects can be added later*

The only remedy was for Andromeda to be delivered to the monster by being tethered to a rock on the coast. She was spared this unhappy fate by Perseus, who came along just in time, fell in love with her, killed the monster and rescued and married her.

Patrick Coughlan reinterpreted the crux of this legend - the idea of the tethered beauty - as an inspiration for a modern figure study. The image is the product of two separate exposures later

assembled electronically into this front and back view' study. The lighting set-up was the same in both exposures and basically is a full-length soft box to the camera left of the model, with fill light provided by a 500-watt tungsten lamp at ground level, reflected off a white panel. The pool of light on the background is from a third 1000-watt tungsten spot, adding interest and providing separation.

## photographer's comment

*Two separate shots of Ms Vicky Lee, one full-frontal, then one rear view. Carefully grafted together via image manipulation.*

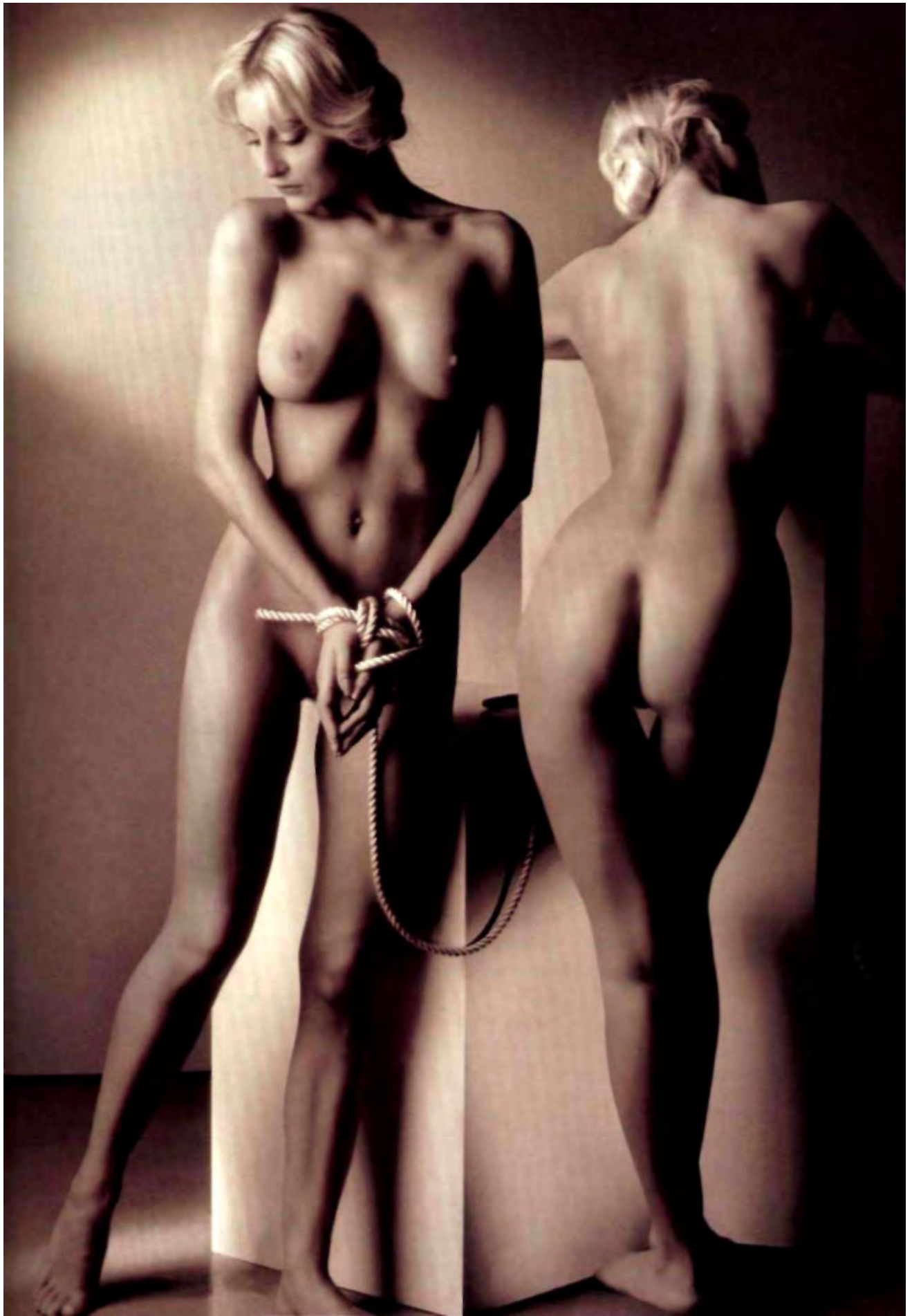

# BITING GLASS

Photographer Frank Wartenberg

**use** publicity  
**camera** 6x7cm  
**lens** 180mm  
**film** Fuji Velvia  
**exposure** not recorded  
**lighting** electronic flash  
**props and background** black velvet, glass

This image is a classic example of the notion of "theatre of cruelty". The drama and element of danger are extremely striking and this is supplemented by harsh, appropriate lighting.

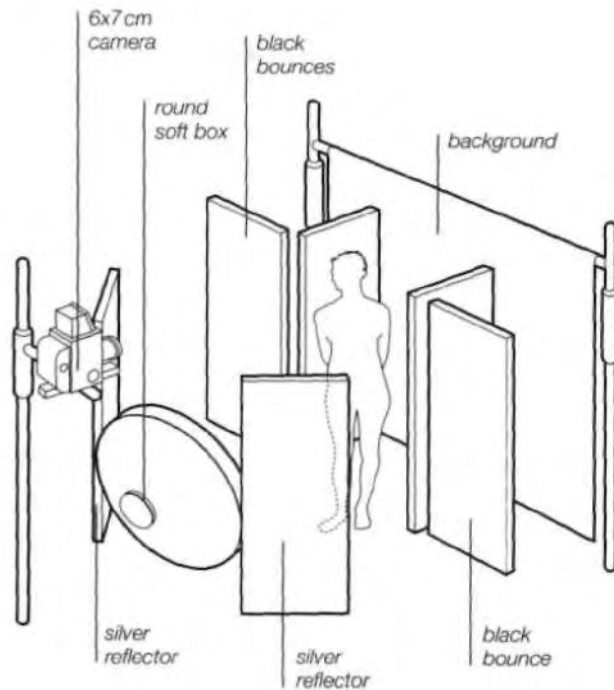
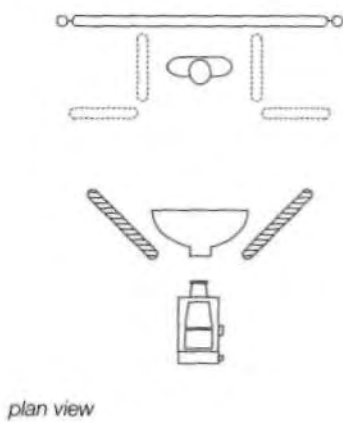

## key points

*In effect the glass shard is backlit because the soft box is in such a low position*

*The silver reflectors concentrate the light from the soft box, making it a very hard form of soft light*

The restrained lighting set-up consists of only a circular soft box and a handful of silver reflectors. Equally important are what might be termed the "anti-light" items of equipment: black panels, black velvet, and dark make-up. The soft box is at a low

position and in close proximity to the model, reducing modelling below the chin to give a flat, almost abstract expanse of skin against which the made-up facial features and all-important glass stand out starkly.



# WHITE BOX RED BACKGROUND

Photographer: Gary Darrar

**use** personal work  
**model** Evelyn  
**camera** 35mm  
**lens** 35-105mm  
**film** Kodak 100  
**exposure** 1 /60 second at f/8  
**lighting** electronic flash  
**props and background** white box, red background

This shot is a stunning example of the use of symmetry to create a formidable composition combined with soft lighting which is well controlled.

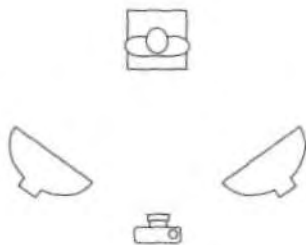

plan view

## key points

*Simplicity is the key to a superb image*

*Choosing the colour of items within a shot is very important when it comes to controlling the contrast ratio*

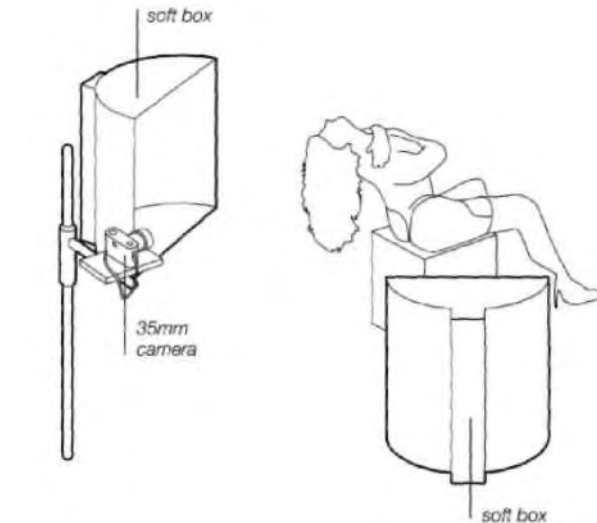

The lighting is also based around the central axis of the shot with two large soft boxes relatively close to the model, one to the left and one to the right. The exposure is closely controlled so that good detail is clearly visible in the beautiful flowing long hair. The white

box, which the model sits astride, is allowed to begin to burn out. This separates the model from the box and the box from the background. Finally the background is well saturated and has a devilishly warm, or in fact very hot, rich colour.

## photographers comment

*I wanted to try another shot, but the model couldn't bend that far.*



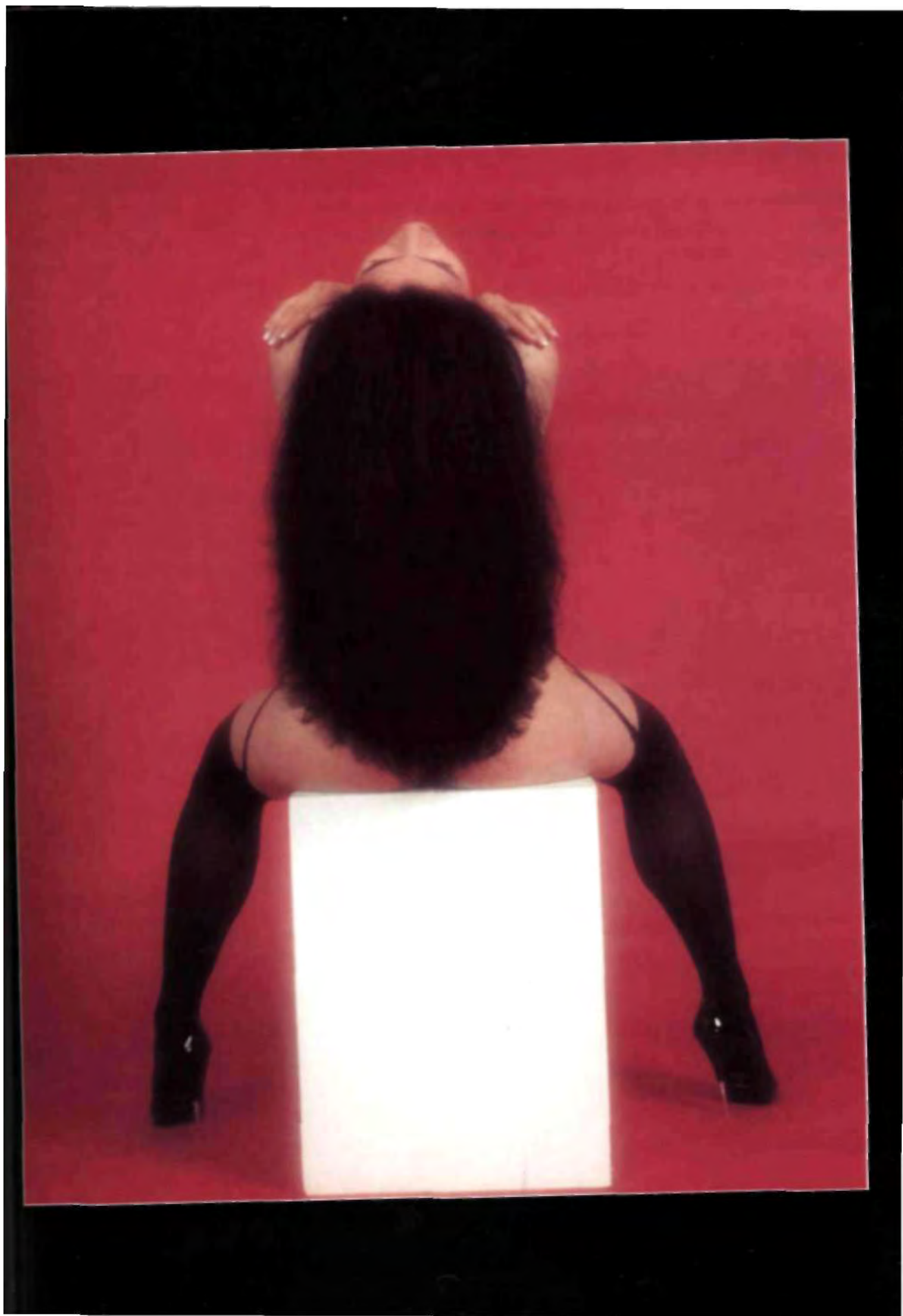

# NICK

photographer **Bob Shell**

**use** stock  
**camera** 35mm  
**lens** 85mm  
**film** Kodak E100 SW  
**exposure** not recorded  
**lighting** electronic flash  
**props and background** inflatable wading pool and shower

**The model's costume has a good reflective sheen on the left-hand side of the camera, deriving from a combination of its wetness from the overhead shower and the not totally light-absorbent blackness of the material from which it is made.**

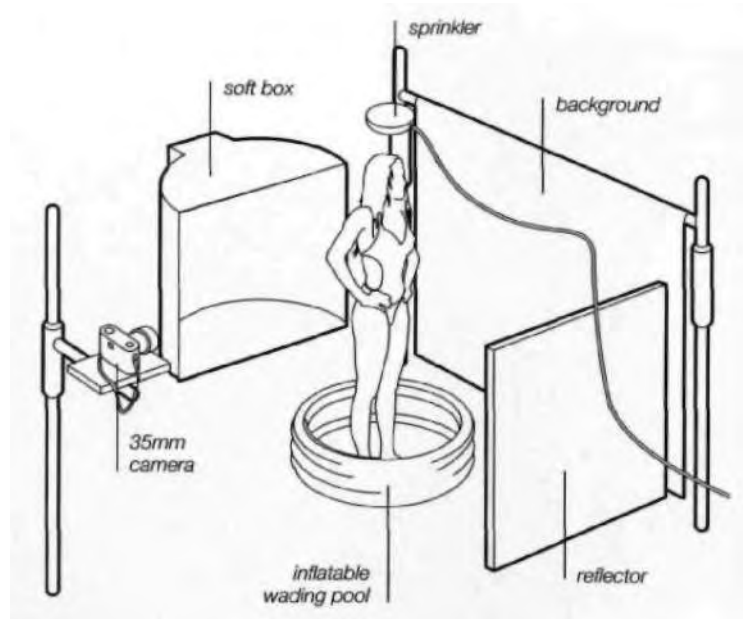
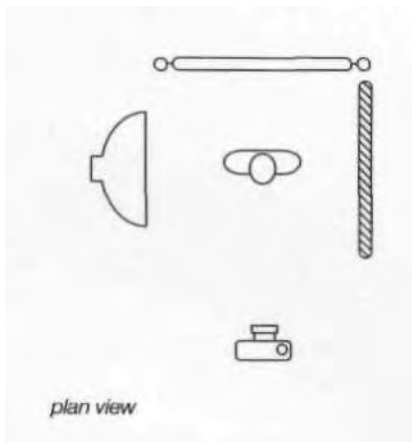

## key points

*The shutter speed is important when working with moving water: it needs to be at the most 1/250 second in order to freeze the water movement*

*Safety considerations are paramount when working with water and electricity*

The single large soft box to camera left is sufficient to give warm, even lighting along the length of the model's body, and her position ensures reflective highlights at just the right point on the costume.

The near arm demonstrates well the use of a white reflector opposite a soft box source. The back half of the arm is very high-key in contrast with the dark,

yet just visibly defined side nearer the reflector. Similarly, notice the difference between the high-key reflective area on the bottom of the swimming costume (soft box side) and the dark, unreflective top (reflector side). It is important that the background is black to keep the overall rich warmth and intimacy of the shot.

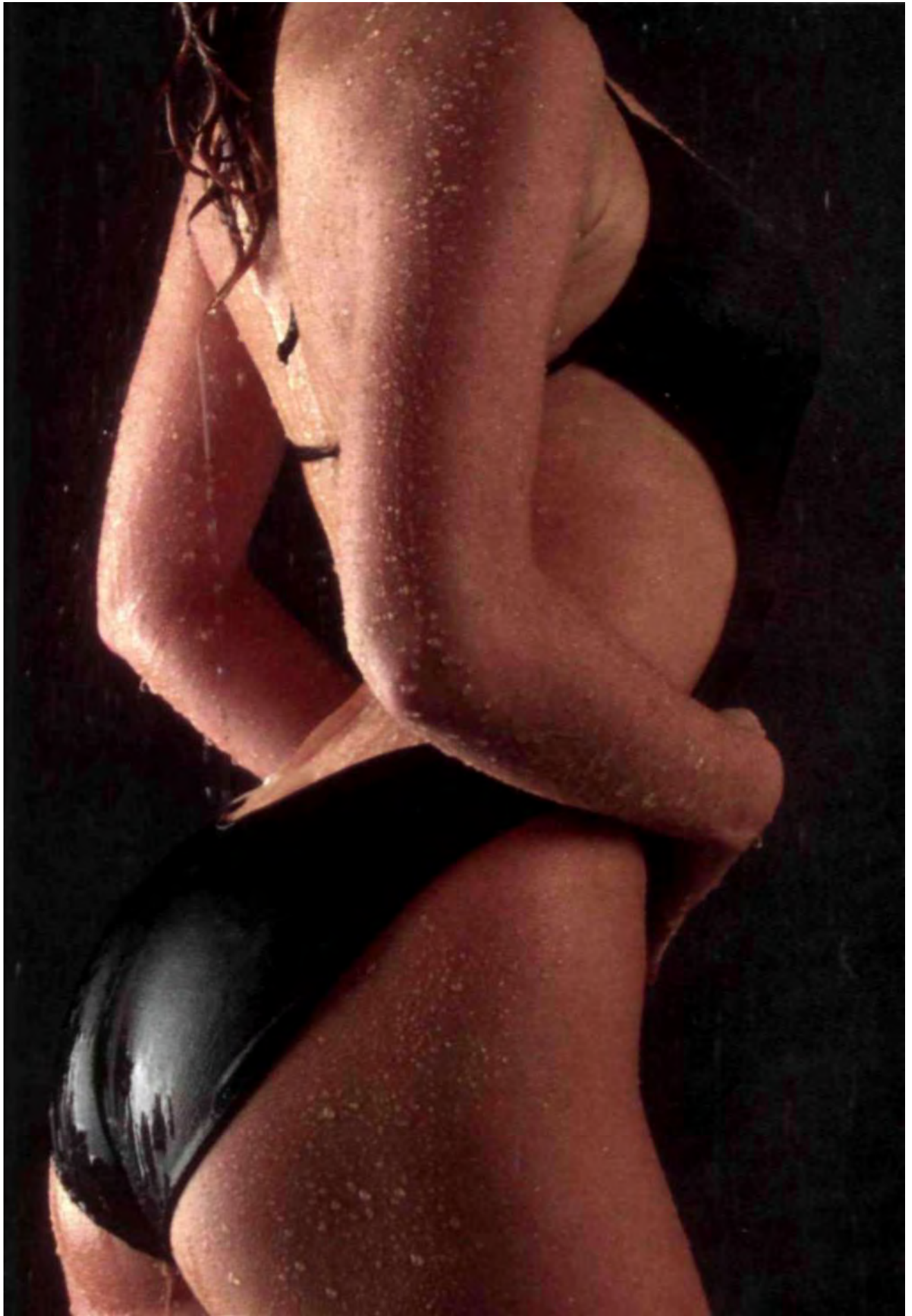

# TIFFANY AND COLLAR

Photographer Bob Shell

**camera** 35mm  
**lens** 35mm  
**film** Fuji Provia 100  
**exposure** not recorded  
**lighting** electronic flash  
**props and background** dog collar and chain

The key light is a large full-length soft box to the right of camera.

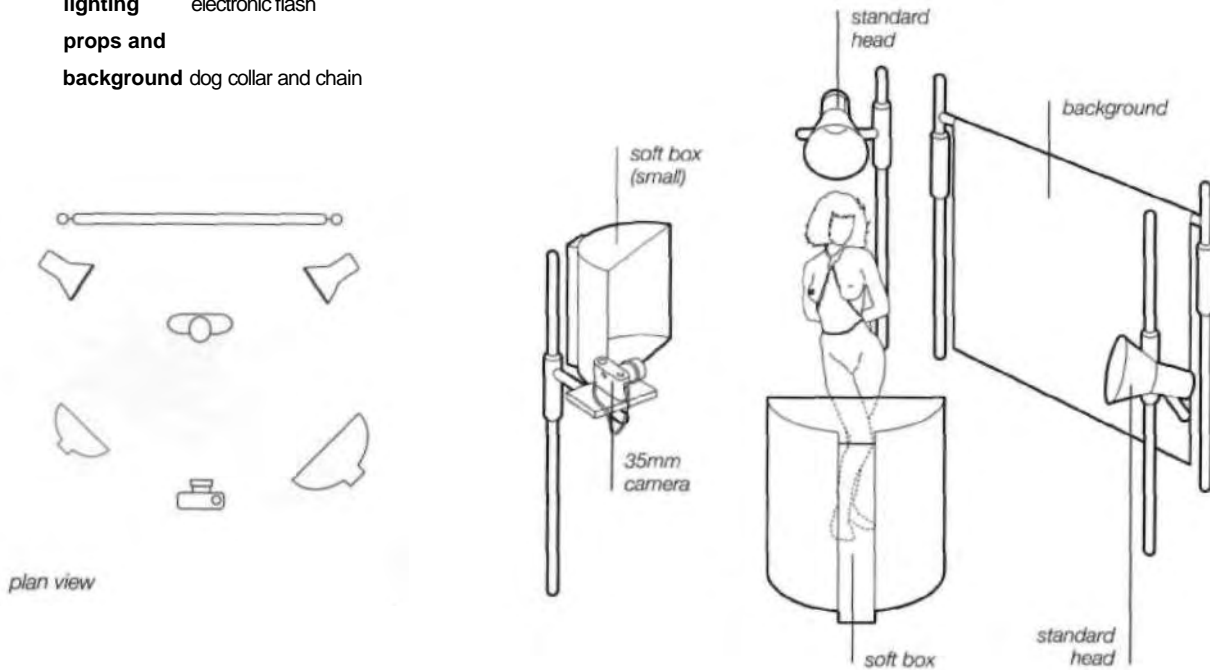

## key points

*Props can change the whole mood of a shot, as can the lighting*

*Work to the strengths of the model*

Fill-light is supplied from a smaller soft box further away and to the left of camera. To the back right there is a standard head which is a rim light. In this instance it is not actually opposite the key light because of the angle of the model's body: she is twisting slightly so the position of the rim light is adjusted accordingly in relation to her. Finally, to the back left there is a standard head accentuating the hair and providing the highlight.

The props for dressing the model are important: the chains, collar, nipple ring and bellybutton ring. The position of the key light ensures that these stand out against the skin. The colour tone of the skin is also important as a backdrop to these items. The necessary rich warm colour (rather than, say, an over-bright, slightly overexposed paleness that might have been chosen in other circumstances) is achieved by careful attention to exposure.



# BLACK BRA

photographer **Craig Scoffone**

**client** Fad Magazine  
**use** editorial  
**model** Tina Joe  
**camera** 35mm  
**lens** 45-125mm  
**film** Kodak Tri-X  
**exposure** not recorded  
**lighting** available light  
**props and background** leather lingerie

**Using available light does not mean simply taking whatever nature happens to give you at any particular moment, as Craig Scoffone demonstrates here.**

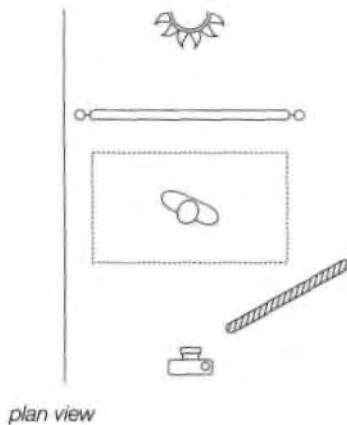

plan view

## key points

*Working outdoors is a perfectly viable option, but the variability of the sun and clouds can delay shooting*

*When working in a studio, the photographer has complete control over the lighting*

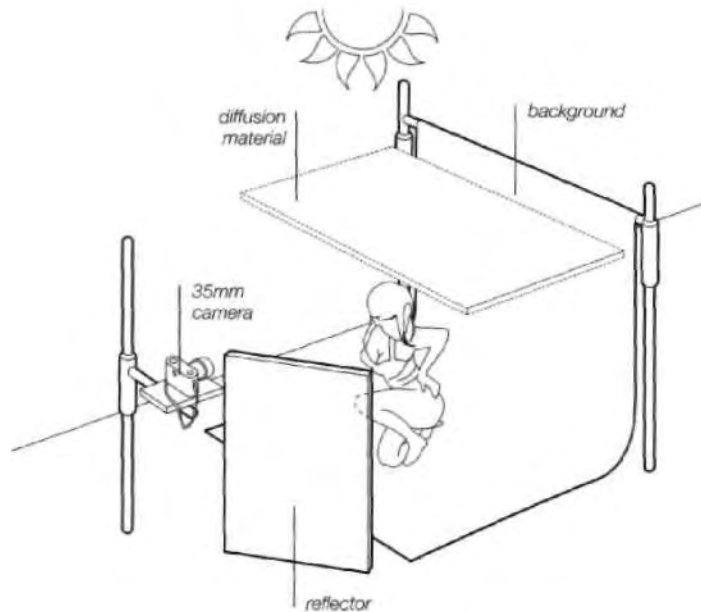

Sunlight can be modified as required. In this case the direct overhead sunlight needed to be diffused, so Craig suspended a silk screen over the area of the shoot to act as a diffuser (just as the silk behaves on the front of a studio soft box). He placed the model against a white wall, which acts as a reflector on the left, and supplemented this with

a white reflector to the right of the camera. The tight crop emphasises the lingerie and the model's limbs are positioned to frame the shot and the centrally important clothing.

The carefully positioned strands of hair hide the model's face and add to the eroticism as well as reinforcing the lines within the picture.

## photographer's comment

*In the patio of my studio I used the subject posed against a white wall under a suspended diffuser to create this photo for an editorial on erotic leather clothing.*



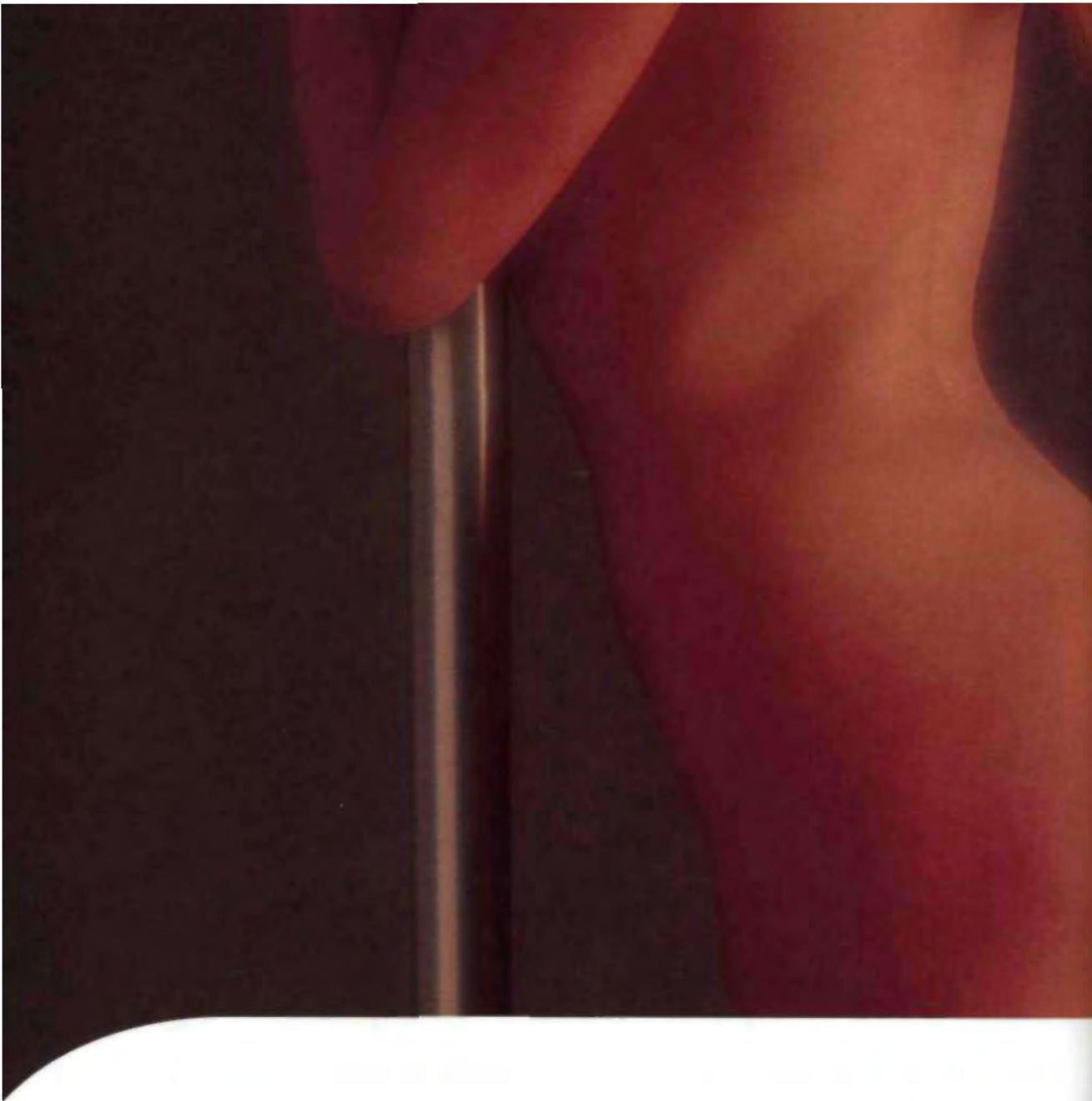

THE ROMANTIC  
LOOK

13



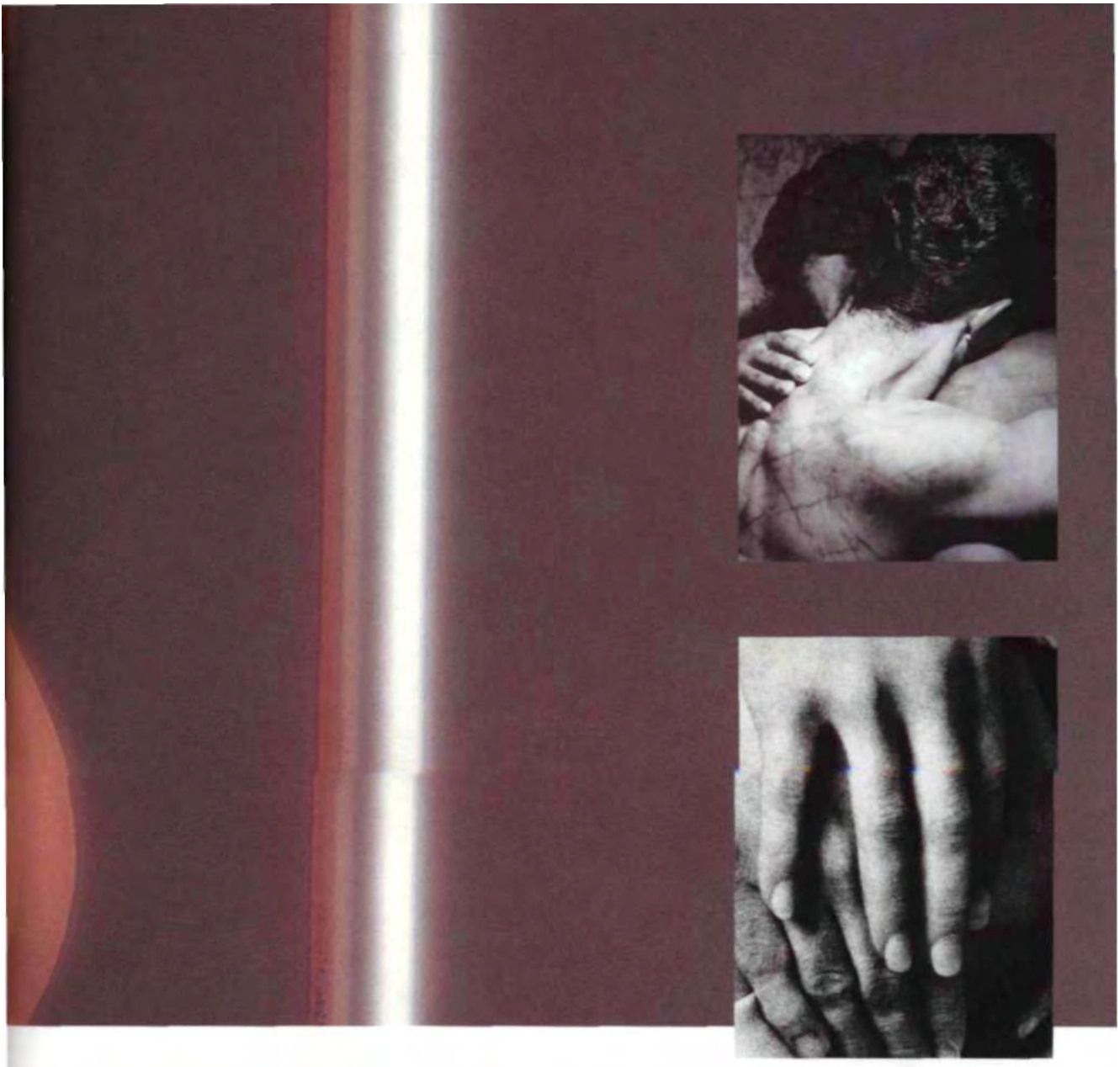

It is no accident that it is only in this chapter that we come to photographs of couples. In most forms of erotic imagery, the viewer is the second party in an erotic scenario, however it is portrayed, and often plays a somewhat voyeuristic role. For a romantic shot, however, the relationship needs to be modified in order to convey emotion and mutual intimacy rather than one-sided voyeurism.

This is not to say that a shot of a single model cannot convey romanticism, as many other images in this chapter will demonstrate. The essence of the romantic shot is the mood, and careful choice of styling, pose, expression and setting can all contribute to a romantic look that involves the viewer in a more emotional and not solely erotic scenario. Generally, romantic lighting is low-key, soft and easy on the eye, the candlelit meal being the classic example of a romantic setting.



# LOVERS

Photographer **Ben Lagunas and Alex Kuri**

**client** Private art  
**use** gallery  
**model** Martou and John  
**assistant** Isak, Christian, Paulina,  
Janice  
**art director** Ben Lagunas  
**stylist** Fabian Montana  
**camera** 6x6cm  
**lens** 350mm  
**film** Kodak Tmax CN  
**exposure** 1/125 second at f/16  
**lighting** electronic flash

**Ben Lagunas and Alex Kuri again demonstrate their mastery of the simple yet effective approach to lighting.**

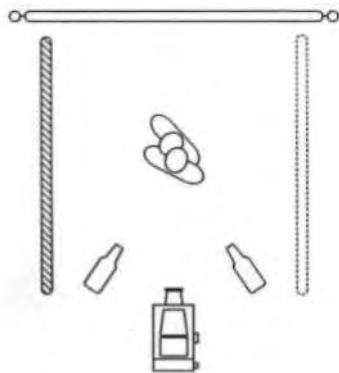

*plan view*

## **key points**

*For establishing a romantic mood, a low-key lighting approach is often the most appropriate*

*The multiplicity of shadows adds substantially to the mood. Naturalistic consistency of lighting is unimportant in this kind of context*

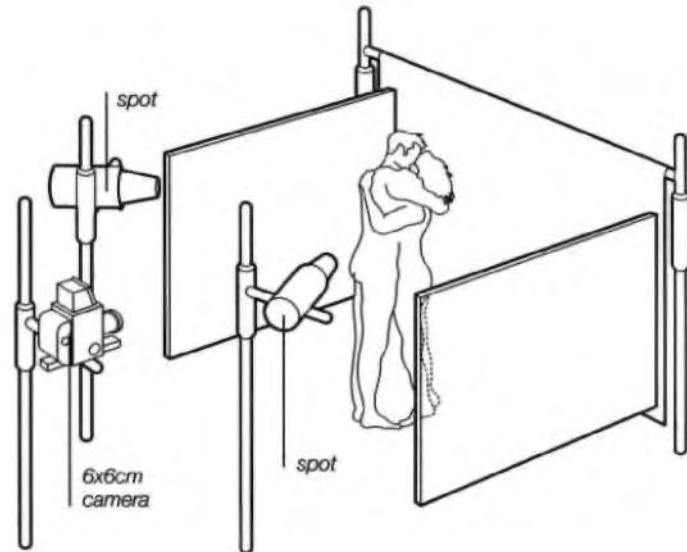

A white panel is placed to the left, a black panel to the right, and two symmetrically positioned focusing spots, higher and further forward than the camera, cross each other and aim at the models. This crossing of the two spots results in shadows both to the left of the far model as well as to the right of the head in the foreground.

The tightness of the focus of the spots means that a relatively restricted

area of the models is high-key - just across the shoulders and heads - while the upper and lower parts of the image remain quite dark, yet adequately illuminated to convey the detail required. The mystique of the shot is the perfect style for the ambiguous nature of the subject matter: the sex of the models is not clear, adding to the risqué eroticism.

## **photographer's comment**

*We used a toner on the paper and a texture to give more drama and force to the concept.*

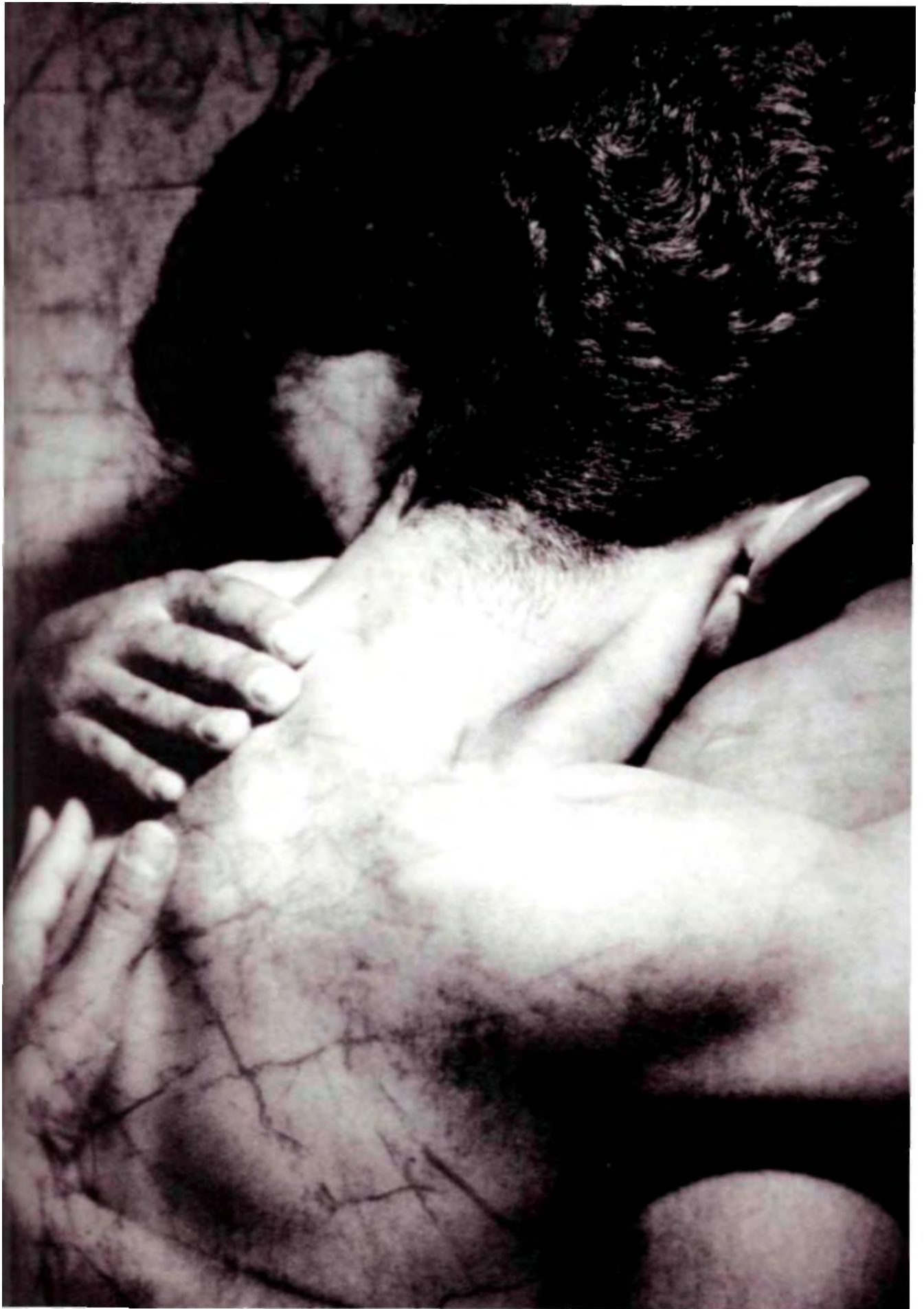

# FARMYARD

photographer Frank Wartenberg

<b>use</b>	publicity
<b>camera</b>	6x7cm
<b>lens</b>	105mm
<b>film</b>	Kodak Tmax 100
<b>exposure</b>	not recorded
<b>lighting</b>	available light

**This erotic shot combines the excitement of outdoor nudity with witty symbolism. The man is holding a long hard staff, and a multi-pronged one at that!**

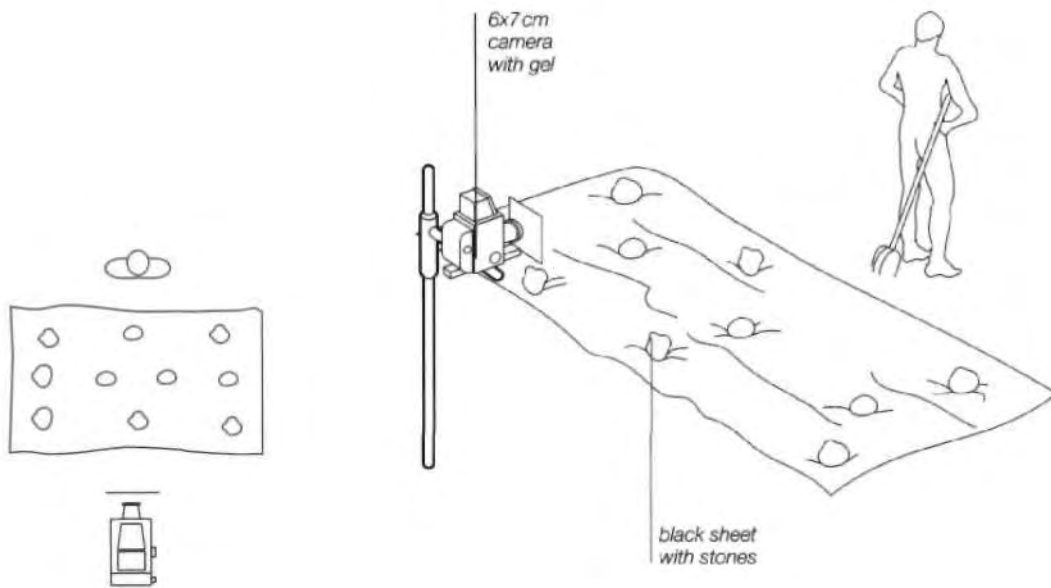

*plan view*

## key points

*When on location, it is possible to use the surroundings as lighting tools*

*A combination of high and low key can provide a means to good separation*

The ground is no accident. It is important that the far ground should be light and higher key for the form of the silhouetted lower body to stand out. This is supplemented and enhanced by the use of a black panel in between the camera and the model, just out of shot and flat on

the ground. This black sheet was weighed down with stones on what Frank Wartenberg describes as a very windy day. It was also very cloudy with no direct sun, but an overcast sky can act like a giant soft box, in this case giving strong highlights on the upper torso.

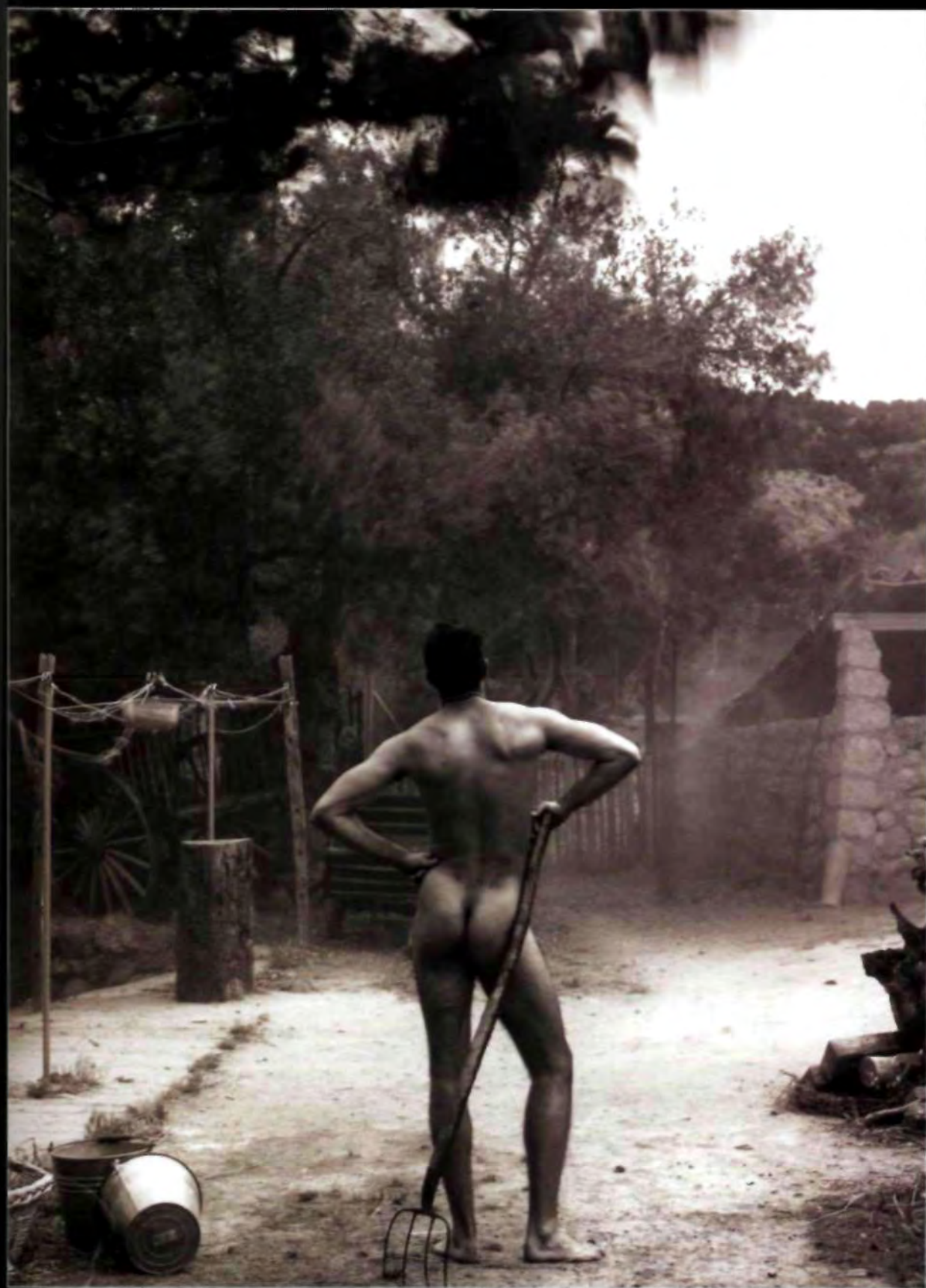

# FUR RUG

photographer Gary Darrar

client Sable Club  
use Internet Site  
model Bridget  
camera 645  
lens 75mm  
film Ektachrome 100  
exposure 1/60 second at f/8  
lighting electronic flash  
props and background bed and rug

The natural feel and look to this shot was produced very simply and easily in a studio setting.

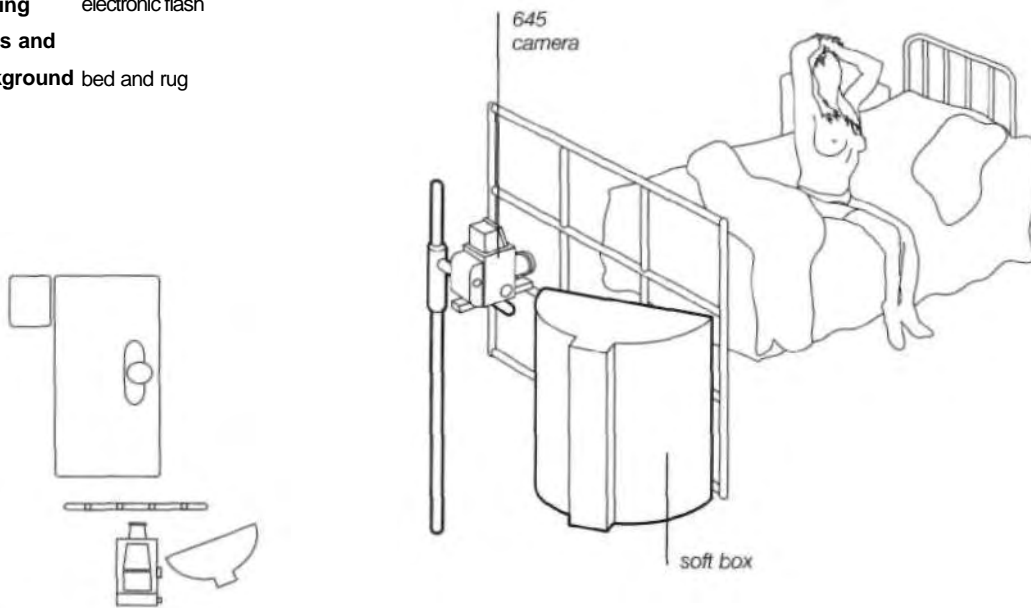

plan view

## key points

*All sorts of common items can be used as gobos*

*A window frame effect can also be achieved by a square wooden frame with the addition of strips of black masking tape to create the cross pieces*

The evening light that seems to come in through a window to the right of camera is actually literally coming in through a window. A window frame placed several feet in front of a large soft box which makes the appearance of semi hard shadows which resemble the uprights and cross pieces.

The image was slightly underexposed to give a lower key effect, the feel of an evening set but without being too dark. Finally, again with the use of the right props to establish the context and mood a bedroom scene is created full of romance and a certain je ne sais quoi.

## photographer's comment

*We were all pleasantly surprised at how well the image turned out.*



# LYNNET

photographer Bob Shell

**us\*** stock  
**camera** 35mm  
**lens** 50mm  
**film** Fuji Provia 100  
**exposure** not recorded  
**lighting** electronic flash  
**props and**  
**background** chaise longue

**The camera is square-on to the model. Directly side-on to the model is a standard head. The lighting is straightforward but the effect is very strong.**

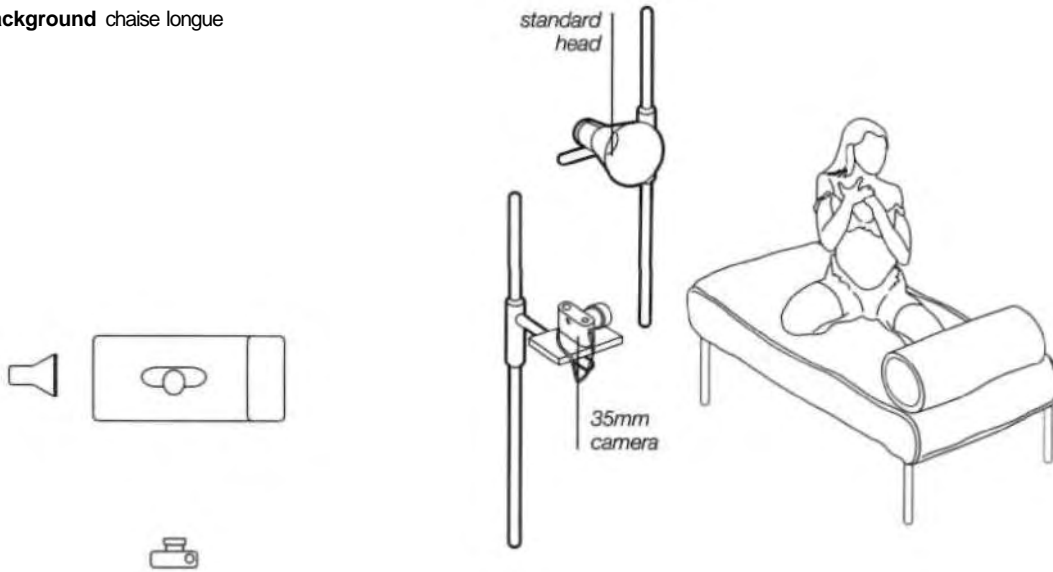

*plan view*

## key points

*Lighting can be used selectively to conceal as much as reveal a subject*

It is, of course, this bold lighting look in conjunction with the styling that establishes the romantic mood of this shot. The chaise longue is a classic romantic prop, and the choice of erotic lingerie is important, as are the alluring pose and expression. Details such as the carelessly slipping shoulder strap add immensely to the powerful erotic charge of the image. Stockings and lace lingerie could be all too clichéd as the standard fare of the erotic shot, yet here Bob Shell has brought a freshness

to a familiar subject. The frank full-frontal pose is one element of the shot's success; the high-contrast look also adds to its integrity (compared with a brightly lit, purely voyeuristic approach), and the less-is-more technique pays off handsomely in relation to the crucial areas of shade, stimulating the imagination. The model's unabashed steady gaze is arresting and engaging. The result is far from being a clichéd erotic shot: it is instead a classic of its type.





# LONG BOOTS

photographer Chris Rout

**client** model  
**use** portfolio and stock  
**model** Lesley-Ann  
**camera** 6x7cm  
**lens** 180mm  
**film** Kodak E100SW  
**exposure** 1/60 second at f/11  
**lighting** electronic flash  
**props and background** grey colourama and colourama poles

**When Chris Rout was looking for inspiration for props for this shot he turned to his large supply of lighting equipment as a source.**

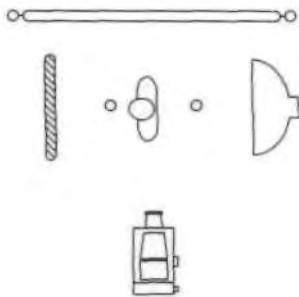

plan view

## key points

*Long vertical props in a shot will emphasize length and can even give the impression of elongating a body*

*Be aware of reflections in shiny objects, control them and work with them, they may add to the composition*

The model was looking for a promotional shot that was sexy but not too common, and as we can see the choice of long stiletto black patent leather boots was a real winner for the costume. The photographer chose to use poles usually used to suspend background material, as the keys props in the shot.

The poles are actually made by Manfrotto, which luckily have a very

good sheen to them, but are actually finished in silky satin rather than highly reflective chrome, which might have caused problems with reflections of the lighting. The lighting set-up is relatively simple, an Elinchrome soft box to the right of the camera with a large 8 x 4 foot white full length reflector panel to the right of the camera. There is just enough detail and highlights in the boots to show of their shape perfectly.



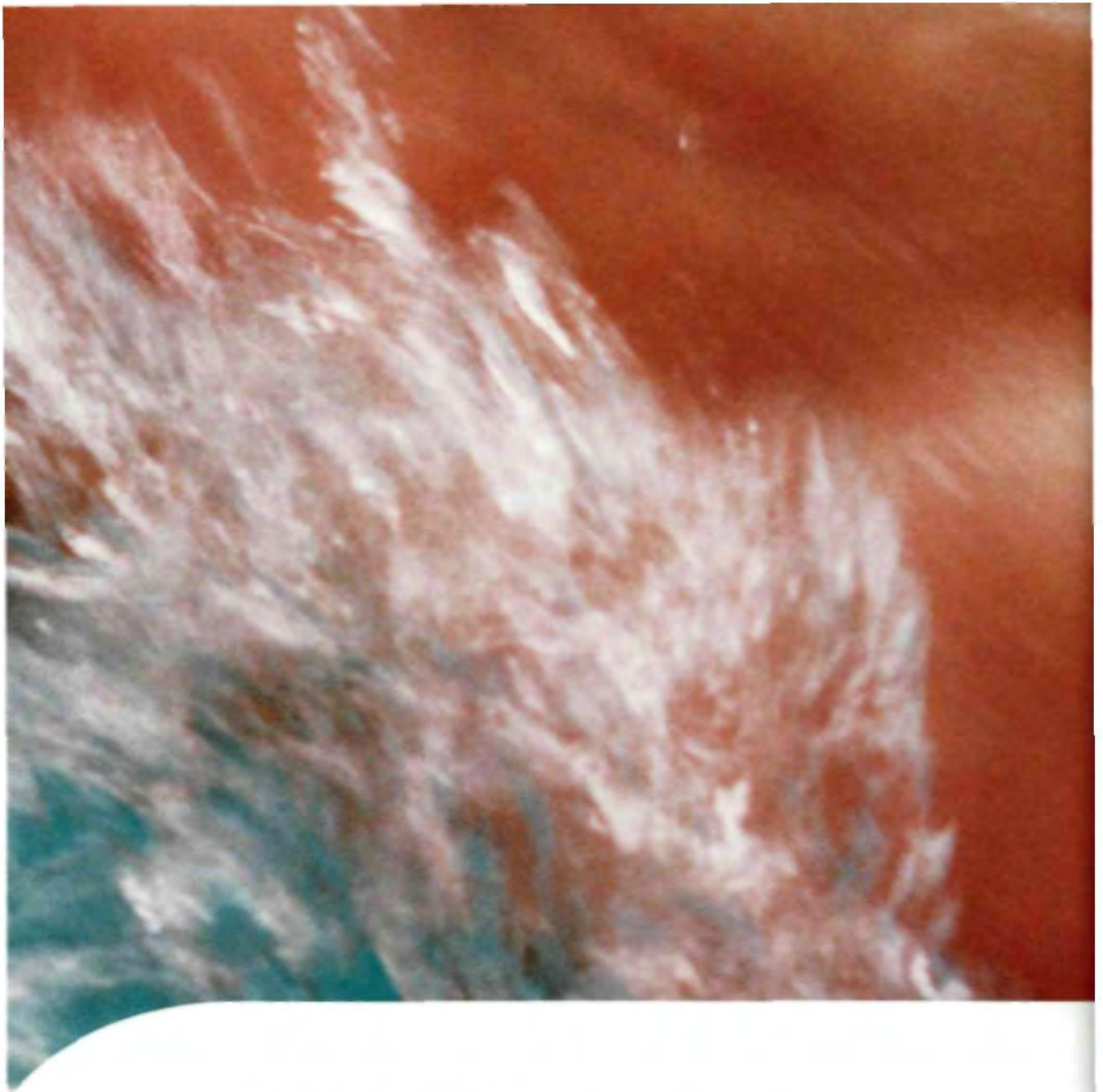

PUSHING the

**14** BOUNDARIES

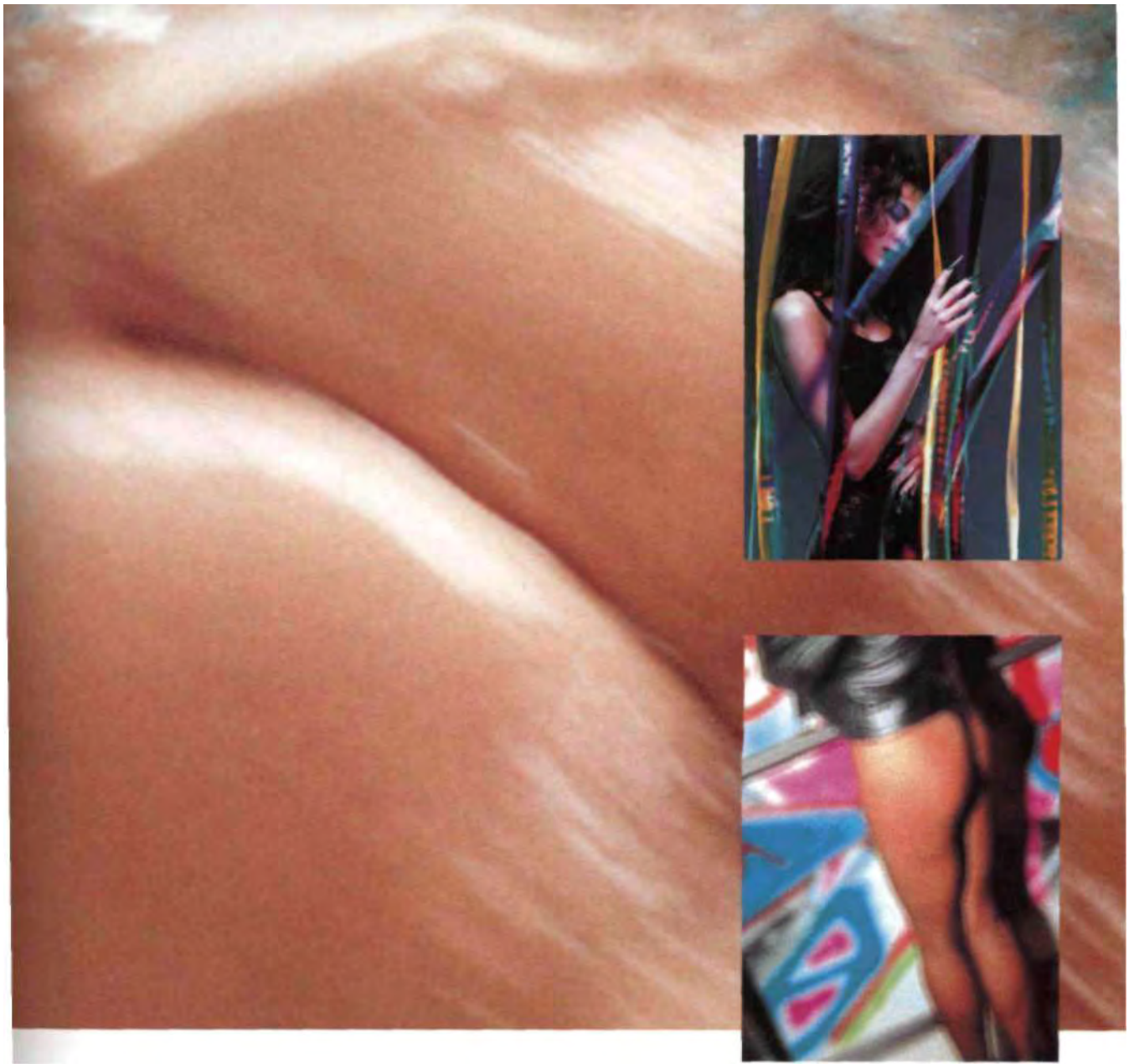

The word "ostentatious" springs to mind with the selection of shots in this chapter. They use bright colours, abstract ideas and a quirky, unusual and, some might say, over-the-top approach. Whether experimenting with manipulation, composition or the very definition of eroticism, the photographers in this chapter are not afraid to explore the unexpected in a variety of ways, using juxtapositions, props and techniques that do not fit easily into the mainstream of erotic photography. This work could be used in a variety of contexts, from fashion advertising to personal fine art work; the erotic element is undeniable, but it is never predictable.

It is important to develop ideas and to keep pushing an idea to its limit, or even beyond, in order to realise exactly what the end result should be. Self-editing is a hugely important skill in this respect. It is also important to keep notes of experimental settings, exposures and lighting set-ups.

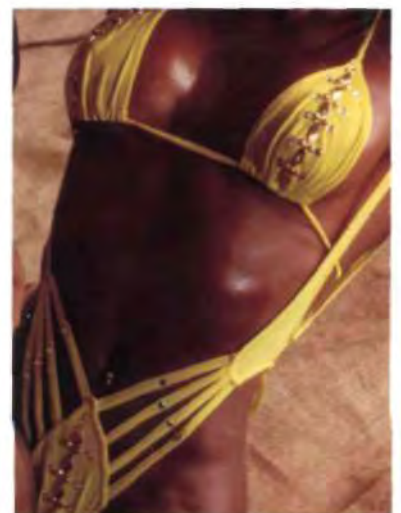

# SEXY REAR

photographer **Maurizio Polverelli**

**client** personal  
**us\*** portfolio  
**model** Birute  
**stylist** Emanuela Mazzotti  
**camera** 35mm  
**lens** 80mm  
**film** Fuji Velvia  
**exposure** not recorded  
**lighting** electronic flash  
**props and background** murals  
**other** elaborated with Photoshop;  
the filter was "Squint" by  
Eye Candy

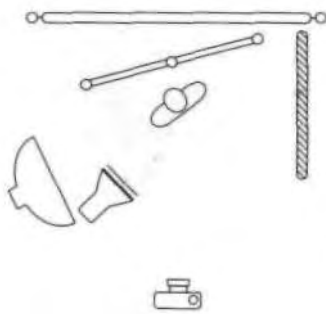

plan view

## key points

*Computer software facilitates all kinds of possibilities but it is important to use it creatively for the effect you want to achieve, and not to be led passively by the preset ideas available*

*It is usually best to shoot an image "clean" as it can be manipulated afterwards*

**The overall illumination of the shot comes from the soft box, which, in turn, is bounced off the white reflector panel facing it on the opposite side.**

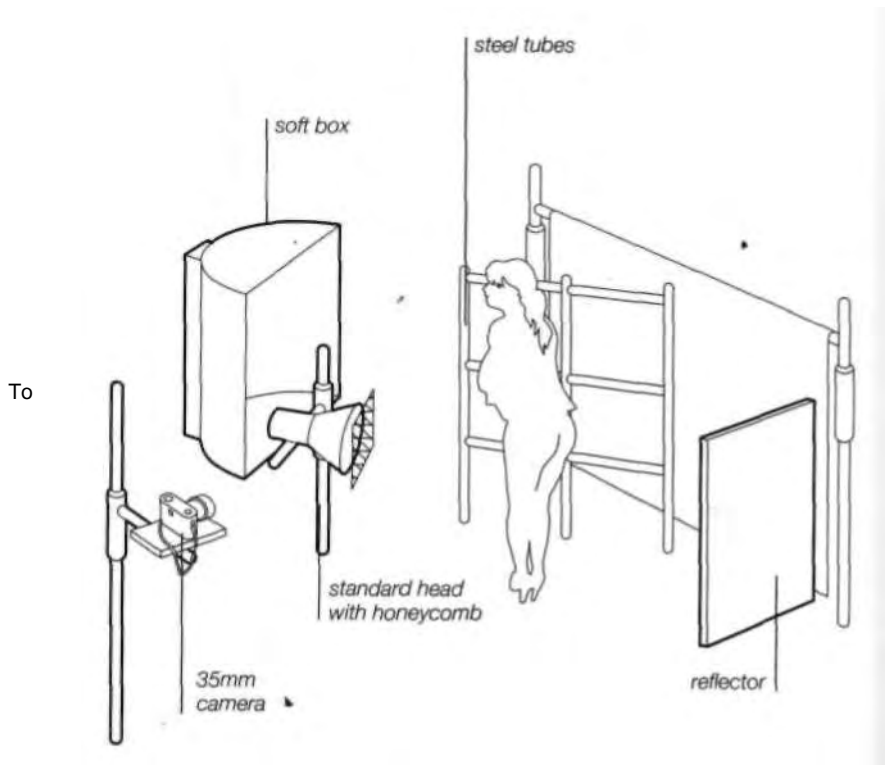

make the erotic point, directional soft light in the form of a standard head modified by a honeycomb adds a hot spot to the (already hot!) "sexy rear" of the title.

The shot is very highly side-lit and the surreal element of the composition is extended by the deep shadow area to the

right of the legs, following their contours closely, and appearing like a ghostly third limb. The choice of leather clothing gives a very reflective area of interest above the flesh zones and the main highlight of the shot is shared between the jacket and the buttocks: careful juxtaposition of two extremely erotic elements.

## photographer's comment

*Sometimes it is better to imagine than to see. The spot point softened with a honeycomb was necessary to create a little hard impact.*

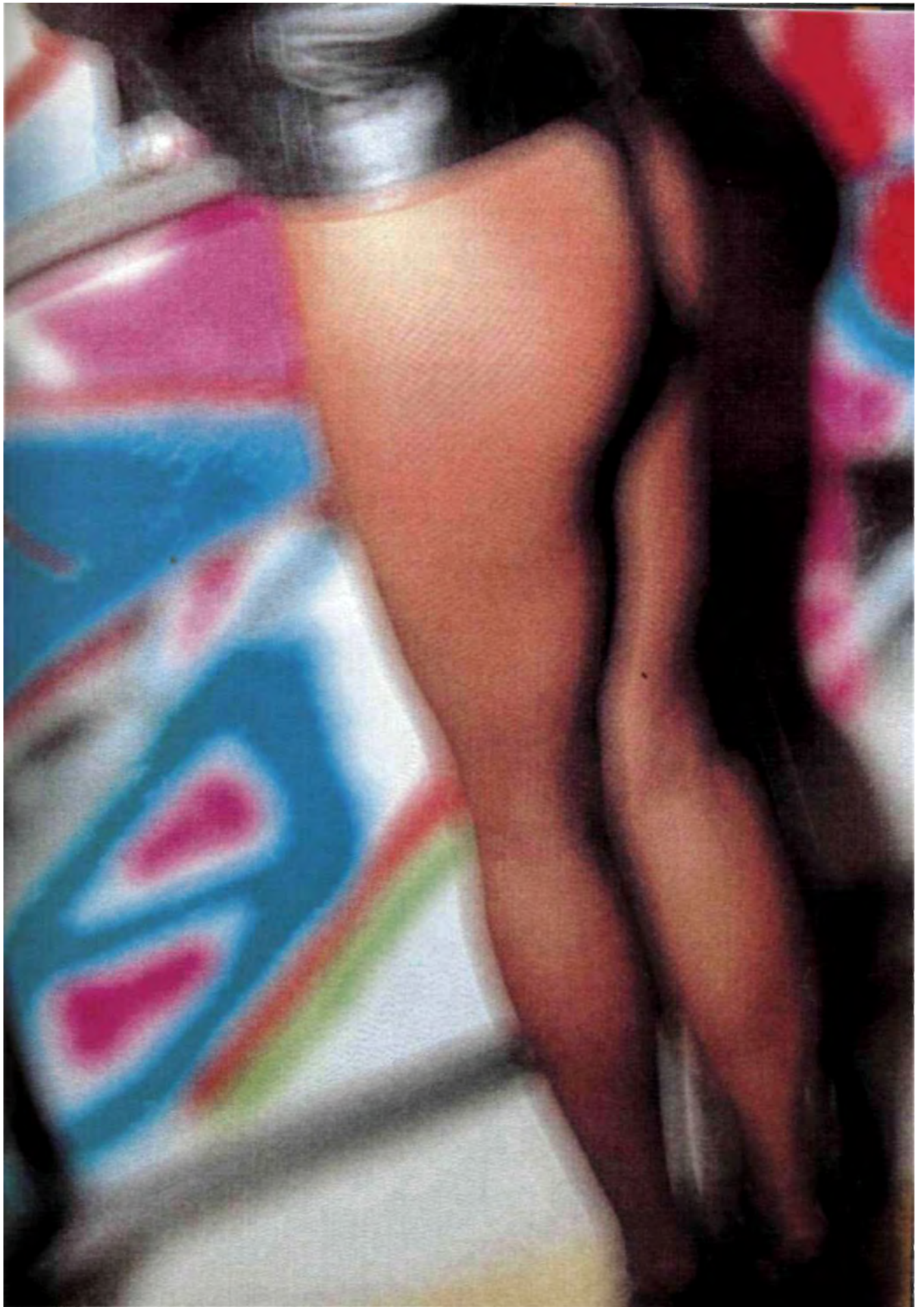

# SOUZAPHONE

photographer Frank Wartenberg

**use** publicity  
**camera** 6x7cm  
**lens** 80mm  
**film** Fuji Velvia  
**exposure** not recorded  
**lighting** electronic flash  
**props and background** sousaphone, and cigar, golden backdrop

There is real emphasis on the gold within this composition. The model is wearing an unusual instrument, which is carefully chosen for its shape and colour.

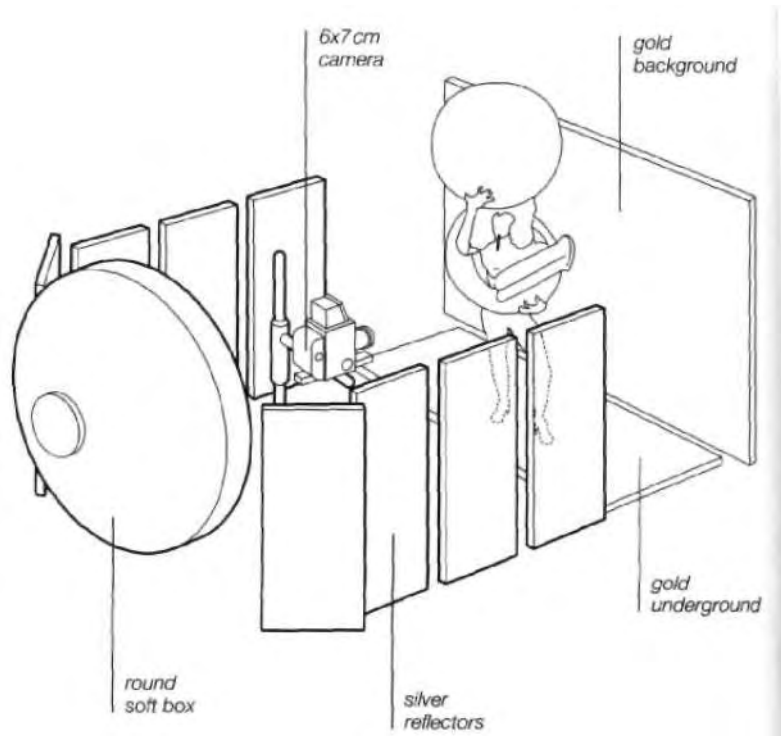
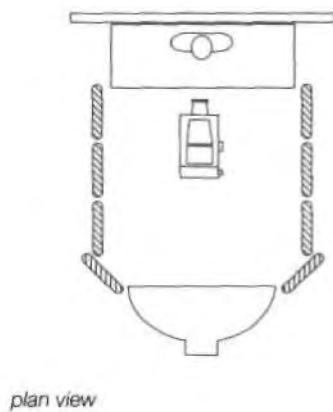

## key points

*The shape or form of a prop can be the inspiration for the lighting*

*Careful attention to detail can bring huge rewards*

Not only is the background golden, but so is the floor. The light source is a very large circular soft box, which is directly behind the photographer. The round soft box is used because it complements the form of the sousaphone and highlights the multiplicity of brass tubes, showing off the curvature to best effect.

To alleviate any chance of unwanted reflections, such as studio walls or crew, the soft box is shot through an enclosure of silver reflectors. Gold bounces could have been used, but this would have diluted the effect in the highlight areas.





# LIPS ON TV

photographer Frank Wartenberg

**use** publicity  
**camera** 6x7cm  
**lens** 180mm  
**film** Fuji Velvia  
**exposure** 1 second at f/22  
**lighting** electronic flash  
**props and background** wall of TVs

**A long exposure was needed in order to capture the full image of the mouth on every TV screen.**

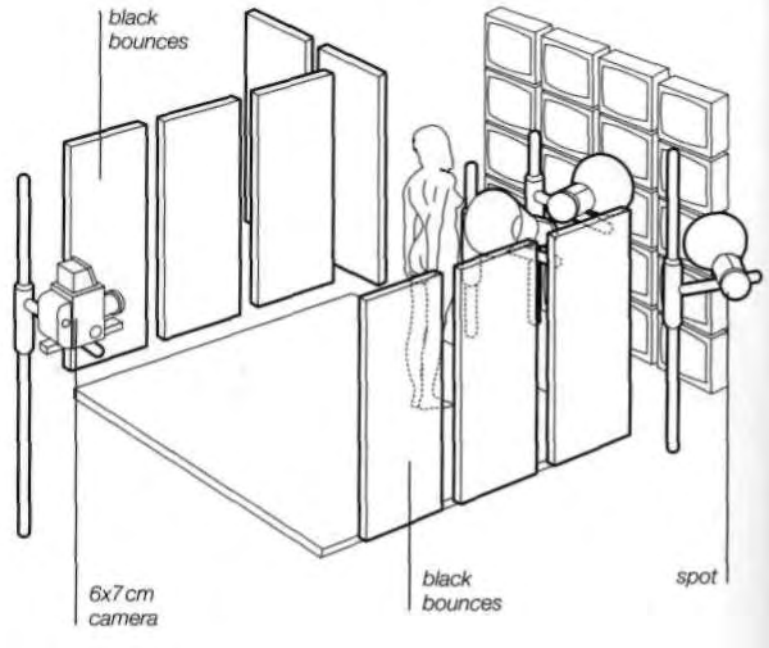
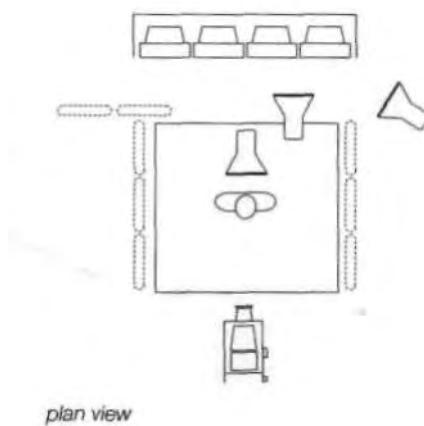

## key points

*Remember to check the colour temperature of any monitor that may appear in a shot*

*An exposure time of longer than 1/30 second will be required to alleviate frame bars*

The illumination on the model comes from an overhead snooted standard head. The remainder of the lighting set-up is concentrated on the wall of television screens that form the background. Of course, the televisions also radiate their own illumination. It is essential that there is no light

spilling onto the TV screens in a way that would produce large blocks of light, detracting from the visibility of the images. Black panels form a tunnel along the raised black floor. This keeps the overall look of the image very low key, seductively revealing the shape and form of the model.



# CICI

photographer Jorgen Ahlstrom

**client** LC  
**MM** editorial  
**model** Cici  
**camera** RZ67  
**ton\*** 90mm  
**filhn** Kodak GPY400  
**exposure** not recorded  
**lighting** UV, tungsten and daylight  
fluorescent tubes **props**  
**and background** grey background,  
wind machine

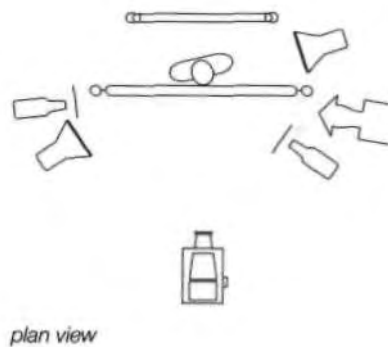

This interesting assortment of light sources creates an unusual look.

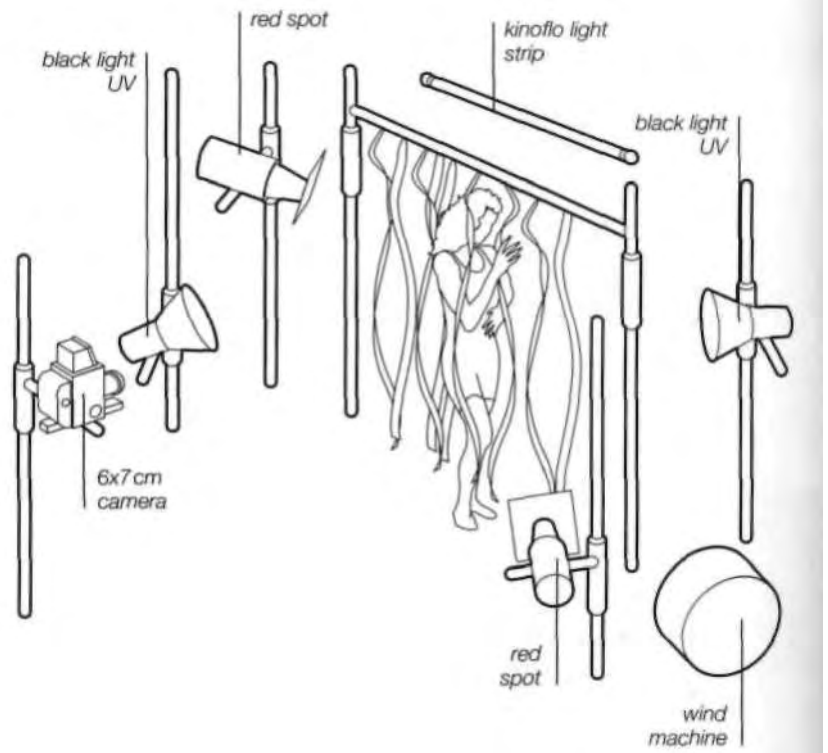

## key points

Black (UV) light is wavelengths shorter **than** about 400nm. Shots in the near ultra violet are possible with most standard lenses down to about 320 nm and most films are sensitive to this. They will record it as a very deep violet.

It is worth testing with UV light to establish how different materials record on film.

The model is standing within a plastic curtain containing many strands, blown by a wind machine, as is her hair. The hand reaching forward through the curtain displays fearsome long black talons. Directly above the curtain and the model is a Kinoflo daylight-balanced fluorescent tube. Skimming along the curtain tails from the left is a tungsten light modified by red gel. Slightly closer to the camera on the same side is a UV black light.

On the opposite side is a roughly mirror-image set-up, except that the UV is slightly more behind on the right and the tungsten with red gel is further round towards the camera. Both the UVC and red tungstens pick up the strands of the plastic curtain to give the interesting look here. The slow shutter speed captures visual echoes of the strands, each with a different colour hue, as they blow in the breeze from the wind machine.



# PROVOCATIVE SHOTS

**The provocative image is nothing if not imaginative. People are not interested in or excited by tame, predictable imagery, and the shots in this book present a wide range of innovative approaches to the subject area from all over the world. This field is intrinsically super-imaginative, and so displays the cutting edge of experimental work, offering an even more unexpected view, an extraordinarily innovative take on the world of the erotic image, or a broadening of the definition of what counts as provocative. Provocative is one step beyond the erotic.**

The erotic frisson has to be there, but there also has to be an element of pushing the boundaries - of the viewer's expectations, as well as the boundaries of the genre.

An interesting way of looking at the genre is to consider the word 'provocative' itself - what exactly is the photographer trying to 'provoke'? A reaction, obviously, but more than this: the provocative shot should be provoking a reaction that the image has triggered - something unanticipated and fresh that exceeds familiar boundaries of content, composition, or even taste. A provocative shot may be a controversial shot, but it is not necessarily so. It is not so much provocation that the photographer is aiming at, in the sense of incitement to irritation or anger, but something more akin to stimulation of the senses - an emotive and emotional reaction to a visually impactful image.

## **The commercial world**

Erotic imagery is used in so many contexts that it seems almost pointless to begin to identify and examine them. However, different applications bring different subtle requirements and the commercial photographer needs to be aware of the boundaries of the context in order to judge their challenge of

those boundaries, and to 'provoke' to just the right degree. What is acceptable imagery in high-street advertising will not be the same as that which is acceptable in the glossy fashion and lifestyle magazines.

Different again are the 'norms' for fine art imagery, postcards and posters, and at the other extreme, calendar and traditional glamour contexts. In order to push the boundary the photographer needs to know exactly what the boundary is. The cutting edge should not be so far removed from the usual reference point that it becomes unacceptably out of place; rather it should just add an edge of excitement to a relatively well-established area.

The contexts into which the photographer of provocative shots may place his or her work are many and varied. There is an ever-increasing demand for mass-produced fine art work. Stock libraries need fresh images for a variety of editorial contexts, and particular commissions for magazine and advertising work will bring their own requirements. Photographs of men, women, groups and couples all have their place, although images of a single model perhaps allow for the greatest versatility of application, since a shot of an individual can either invite the

viewer to identify with the model (essential for some forms of advertising and commercial work) or can allow the viewer to project a virtual relationship and intimacy with the subject of the image.

Health and beauty editorial work often has an overtly sexual element and the impulse of the provocative genre may be just what the campaign needs to grab the attention of the potential consumer.

Personal work for exhibition, private commission or simply as personal development and experimental work, is well represented amongst the shots featured in this work. This is hardly surprising, since provocative shots are by their very nature an experiment with the boundaries and extremes of the imagination, and photographers need to invest time in themselves in order to develop their visual imagination and enter new areas. Some of the most challenging images in the book tend to be those where the photographer is not bound by anyone else's vision, and is not working to commission, but is truly exploring all the creative possibilities.

## **Film, cameras, and lenses**

Not only are provocative shots likely to be experimental in many cases, but

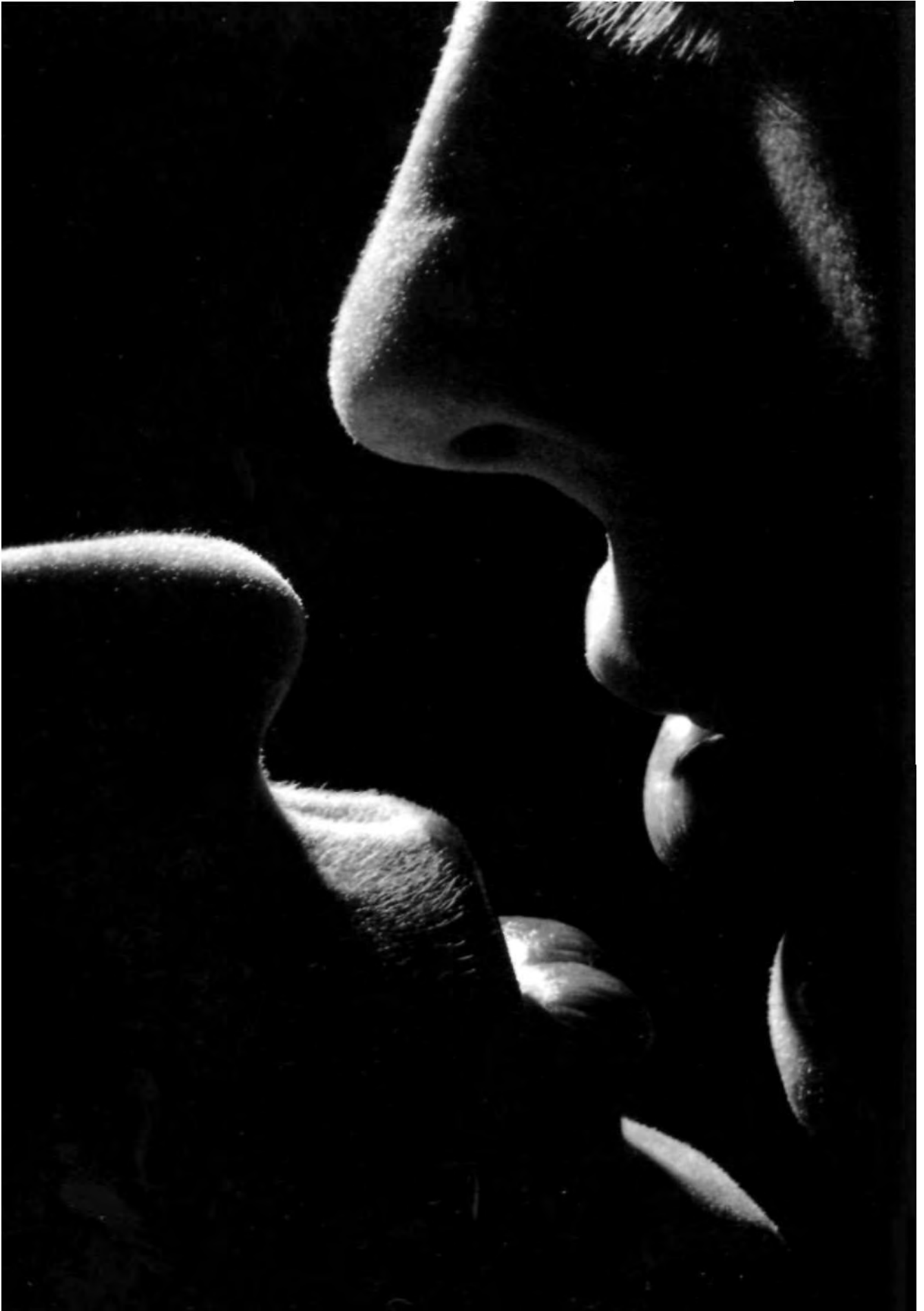

example, see Mark Joye's "Geneviève". On the other hand, an inspirational prop may be the impetus for imagining and planning a shot to every last detail. Look at Mark Riedel's "Mud Girl with Bone" as an example of this kind of image.

### **Lighting equipment and mood**

However much thought has gone into styling, content and composition, it is inevitable that ultimately it is the lighting that will define the mood of a shot, and atmosphere is all when it comes to creating a successful provocative image. To create this, the photographer should be fully aware of the potential of a variety of lighting equipment.

In many cases, the hard source is the more versatile starting point as it can be adapted to become a soft source whereas to do the opposite is not so easy. At the most basic level, standard heads with soft box attachments are a good place to begin assembling a set-up, along with a range of modifying items such as gels, gobos, barn doors, and so on, whether professionally made or improvised by the imaginative photographer. Many everyday household items can easily be adapted to become modifiers of various kinds: stockings over the lens, home-made cut-out paper gobos; and coloured fabric, coloured paper and any number of reflective items can be used as reflectors. (Always remember, however, that safety must always be at the forefront of the mind where improvised lighting props are concerned. Lights get extremely hot and great care must be taken not to

place any possibly flammable materials anywhere where they might constitute a fire hazard.)

### **The shooting session**

It cannot be emphasised too strongly that it is essential for both the photographer and the model to establish from the outset a completely professional method of working. Although the nature of the final image that must be produced is essentially of an intimate nature, this is best achieved by establishing a professional yet relaxed atmosphere where all parties know what to expect of each other and have agreed on a way of working towards the desired result.

Clear briefing of the model (and any crew) beforehand will make explicit what is wanted, and the model can then be prepared for the session and will not feel that anything has been 'sprung' on her or him which might be a problem if they are not at ease with what is requested. Full involvement with the planning process will minimise any such unwanted and time-wasting problems.

A balance needs to be struck between keeping a professional difference and striking up a favourable working relationship and rapport between photographer and model. The best work will emerge where there is mutual understanding and respect, and if a opportune knowledge of each other's working style can be arrived at too, there will be dividends in terms of useful anticipation of each other's probable moves and requirements. The

photographer needs to develop a clear understanding of the strengths and capabilities of the model and to develop a strong relationship whereby the best performance can be elicited for the shoot. However, the model needs to feel at ease with and be able to trust the photographer's judgement, and time spent on model test shoots are never wasted if they help to build up a working relationship that will come to fruition when it really matters on a commissioned shoot.

An ongoing relationship is not always possible, of course, and if working from cold with a model for a specific shoot, a good manner is essential to establish the right mood and atmosphere. Each photographer has his or her own style of directing the shoot, and this is a particular kind of skill in itself, and an invaluable one to develop. Music, light conversation, refreshments and space for the model to change and relax may all play a part, just as much as time spent briefing the model and crew.

It is important always to remember that a great deal of vulnerability is inevitably never far from the surface in a nude or almost-nude shoot, and this has to be allowed for with sensitivity and professionalism at all times. The presence or absence of other crew may or may not help to establish the correct balance between the necessary professional approach and the all-important intimate atmosphere that will surely show through on the film. Again, consultation with the model is important and a mutually agreeable arrangement must be arrived at.



they are also likely to feature models in a variety of unusual and interesting poses, sporting unusual and interesting make-up and clothing, and revealing a considerable amount of bare skin. The appropriate choice of film stock has to take account of these elements of subject matter and composition.

A good awareness of skin tone is an essential prerequisite for any photographer working seriously in this area. There are many film stocks available and it is important for the photographer to have a good feel for how each stock will render the endless variety of human skin tones and colours. For example, some film stocks offer a warm tone preventing the need for endless warm-up filters to enrich the colour of the skin.

Cross-processing is an option that many photographers are currently exploring. It offers an interesting look with increased contrast, heightened colour intensity, and an often cyan tinge in the low-lights, amongst other characteristics, although the results can be somewhat unpredictable. Tones and tints offer a further range of visual possibilities. Films such as Ilford's XP2 black and white stock, which is normally processed in C41 chemistry, can be put through a pushed or pulled E6 process, to give instead a blue or green tinted black and white transparency. The end result required and the nature of the commission will determine the choice of camera format and lens. If enlargement on a large scale is planned (for example for an advertising campaign poster), then as

large a format as possible at the shooting stage will bring better quality (i.e. a less grainy image) later. In many situations a 35mm camera will be the most convenient choice, especially if the work is experimental and the shoot involves active and spontaneous movement on the part of the model and speedy reactions and mobility on the part of the photographer. In other situations, a shot may be carefully planned to the last detail and a tripod-mounted medium-format camera will be more appropriate.

The same is true when it comes to the choice of lens. If a tightly cropped, close-in and intimate look is wanted, a long lens will serve the photographer well, filling the frame and reducing depth of field while allowing the photographer to work from a convenient distance. For a provocative shot, this physical distance between photographer and model may help with the general ease of the model in the studio situation, and can be a significant factor in attaining the right mood of relaxation that will make the shoot a success. It is also easier to light the subject when there is a little more space available to play with.

When working with models, it is useful to know what effects different lens types will produce, in order to accentuate a model's individual features. A wide-angle lens gives the effect of elongating and slimming, and few models will object to this illusion! However, it is also essential to be aware of how to capture a naturalistic representation of the subject using a

more standard lens, and how to allow for any unwanted fore-shortening effects by adjusting the camera position.

### **Clothes, props and make-up**

Clothing has an important part to play in many provocative shots; it can be arranged so as to reveal just the right amount, to accentuate the body form beneath, and to add interest with framing and enhancement of selected body areas. Make-up and hair-styling are equally important; make-up can be used playfully to give a surreal look to the model, or more subtly for an innocent look, or somewhere in between to add a touch of glamour. Both must be carefully considered and executed by artists who are able to maintain the photographer's desired look throughout what might be a long and hot shoot. Styling of the whole composition establishes an effective harmony (or dissonance, if that is what is required) for the whole of the scenario.

The choice of props is another crucial factor. Not only must the right item be selected for the shot, but it must be exploited in the most effective way. Graphic and textural form are primary considerations when selecting props. They can also provide something for the model to respond to and interact with, and can stimulate the progress of a shoot and introduce a spontaneity to the exploration of the possibilities. An interesting chair or table, or even a wooden block, can encourage both model and photographer to try out new positions and effects in unplanned ways; for